

タダノ オールテレーンクレーン

ATF-220G5(J) 型

仕 様 書

キャリヤ : FAUN ATF220G-5

スペック番号 : ATF-220G-1-90101

(クレーン製造番号 GB0170～)

「フルオートラフィングジブ」の詳細については 別冊の仕様書をご覧ください。

株式会社 タダノ

ATF220G-5型 220 t オールテレーンクレーン

1. 主要諸元

◎ クレーン

クレーン容量

ブーム	13.2 mブーム	220,000 kg × 2.5 m	(2×19本掛、アタッチメント付)
	17.4 mブーム	108,000 kg × 5.0 m	(15本掛)
	21.6 mブーム	108,000 kg × 5.0 m	(15本掛)
	25.8 mブーム	94,000 kg × 6.0 m	(13本掛)
	30.0 mブーム	80,000 kg × 5.0 m	(11本掛)
	34.1 mブーム	70,000 kg × 6.0 m	(10本掛)
	38.3 mブーム	54,500 kg × 8.0 m	(8本掛)
	42.5 mブーム	43,500 kg × 8.0 m	(7本掛)
	46.7 mブーム	34,500 kg × 10.0 m	(5本掛)
	50.9 mブーム	28,500 kg × 11.0 m	(4本掛)
	55.0 mブーム	23,000 kg × 12.0 m	(4本掛)
	59.2 mブーム	18,800 kg × 16.0 m	(4本掛)
	63.4 mブーム	15,000 kg × 20.0 m	(4本掛)
	68.0 mブーム	13,800 kg × 16.0 m	(4本掛)
	シングルトップ	7,800 kg	(1本掛)

[参 考]

フルオトラフィンギジブ	8.5 m ジブ	27,500 kg × 7.0 m	(4本掛)
	11.6 m ジブ	14,600 kg × 16.0 m	(2本掛)
	14.7 m ジブ	13,900 kg × 12.0 m	(2本掛)
	17.8 m ジブ	13,500 kg × 8.0 m	(2本掛)
	20.9 m ジブ	5,600 kg × 34.0 m	(1本掛)

最大地上揚程 ブーム 68.0 m

[参 考] フルオトラフィンギジブ 86.0 m

最大作業半径 ブーム 64.0 m

[参 考] フルオトラフィンギジブ 60.0 m

ブーム長さ 13.2 m ~ 68.0 m

ブーム伸縮長さ 54.8 m

ブーム伸長時間 54.8 m / 510 s

主巻ロープ巻上げ速度 107 m/min (4層)

主巻フック巻上げ速度 7 m/min (15本掛)

補巻ロープ巻上げ速度 107 m/min (4層)

補巻フック巻上げ速度 107 m/min (1本掛)

ブーム起伏角度		0.7° ~ 84.0°
ブーム上げ速度		-0.7° ~ 84.0° / 67 s
旋回角度		360° 連続
旋回速度		1.2 min ⁻¹
ワイヤロープ	主補	巻 径 21 mm × 長さ 415 m 巻 径 21 mm × 長さ 310 m
フック		125 t 吊 + アタッチメントシーブ (19 本掛 × 2) 125 t 吊 (15 本掛) 80 t 吊 (11 本掛) 25 t 吊 (3 本掛) 7.8 t 吊 (1 本掛)
ブーム形式		箱型 7 段油圧伸縮式 各段ピンロック方式
ブーム伸縮装置		複動油圧シリンダ直押式 1 本
シングルトップ		先端ブーム取付横折曲格納式
巻上装置		油圧モータ駆動遊星歯車減速式 自動ブレーキ シングルウインチ 2 基
ブーム起伏装置		複動油圧シリンダ直押式
旋回装置		油圧モータ駆動遊星歯車減速式 ボール式スイングベアリング 手動フリースイッチ 手動操作式旋回ロック
カウンタウエイト		71 t、47 t、35 t、23.5 t、12 t、0 t
アウトリガ		全油圧式 H 型 スライド・ジャッキ各個操作装置付 最大張出幅 8.3m 中間張出幅 7.0m、5.6m、4.6m スライドロック用ピン付 スライド格納式フロート
動力取出方式		上部専用エンジン
	名 称	OM906LA (ベンツ製)
	形 式	水冷 4 サイクル 直列 6 気筒 直接噴射式 排気ターボ過給 インタークーラ付 ディーゼルエンジン
	総排気量	6.37 L
	最高出力	138 kW {188PS} / 1,800 min ⁻¹ {rpm}
	最大トルク	750 N·m {76kgf·m} / 1,200 min ⁻¹ {rpm}
燃料タンク		250 L

油 圧 ポ ン プ	高圧可変比ポンプ 2個 +高圧比ポンプ 1個 +高圧キャブ 2個
作 動 油 タ ン ク 容 量	946 L
安 全 装 置	過負荷防止装置 (AML) 作業範囲制限機能付 フック移動量表示機能付 アウトリガ張出幅自動検出装置 (個別検出式) 旋回範囲制限機能 旋回自動停止機能 ブーム起伏緩停止機能 巻過防止装置 捨巻確保装置 水準器 玉掛けロープはずれ止め 旋回ロック装置 油圧安全弁 油圧ロック装置 (伸縮・起伏・巻上・ジャッキ)
付 属 装 置	カウンタウエイト着脱装置 ブーム起伏微速モード設定装置 旋回微速モード設定装置 ブーム着脱装置 AML外部表示灯 風速計 オイルクーラー クレーンキャブエアコン AM・FMラジオ ドラム視認モニター 旋回音声警報装置 リフトアジャスタ 携帯通信装置 (HELLO-NET Owner's Site) (#GB0195～)
オ プ シ ョ ン	拡声器

キャリヤ					
メーカ名					FAUN GmbH
キャリヤ型式					ATF 220G-5
エンジン	型	式			OM502LA (ベンツ製) 水冷4サイクルV型8気筒直接噴射式 インタークーラ付ターボ ディーゼルエンジン
	総排気量				15.928 L
	最高出力				390 kW{530PS} / 1,800 min ⁻¹ {rpm}
	最大トルク				2,400 N·m{245kgf·m} / 1,300 min ⁻¹ {rpm}
変速機形式					フルオートマチック 前進16段、後退2段
駆動方式					10×6 10×8 ---オフロード (デフロック機構付)
車軸形式 (全軸)					全浮動式
懸架方式 (全軸)					ハイドロニューマチックサスペンション サスペンションストローク
ステアリング	形	式			左ハンドル 全油圧式パワーステアリング 2系統式 非常用パワーステアリング
	モ	ー	ド		ノーマル (前4輪+後4輪) クラブ (前4輪+後4輪)
ブレーキ	主ブレーキ				空気式全輪制動 2系統式
	駐車ブレーキ				2・4・5軸 (6輪) 制動スプリング式
	非常ブレーキ				駐車ブレーキと兼用
	補助ブレーキ				流体式リターダ (変速機内蔵式) 排気ブレーキ
バッテリー容量					12V - 170Ah × 2個 (24V)
燃料タンク容量					530 L
乗車定員					2人
タイヤ					445/95R25 177E ROAD (全輪)
ホイール					11.00 - 25 (全輪)
付属装置					カーエアコン AM・FMラジオ マッドガード 集中給油装置 仮眠用ベッド バックモニタ

走行時寸法

全	長	13,430 mm
全	幅	3,000 mm
全	高	3,990 mm
軸	距	2,700 mm + 1,650 mm + 2,440 mm + 1,700mm
輪	距	2,540 mm

重 量 (公道走行状態)

車 両 総 重 量		40,110 kg (人員 2 名)
前 軸 重	1 軸+2 軸	19,270 kg
後 軸 重	3 軸	1,290 kg
後 軸 重	4 軸 + 5 軸	19,550 kg

走行性能

最 高 速 度		85 km/h
登 坂 能 力	(tan)	0.7
最 小 回 転 半 径		9.8 m

- (注意) 1 . 本機は、公道を走行する場合には、ブームおよび起伏シリンダを取外して別送し、旋回体を後方向に向けた状態で走行しなければなりません。
- 2 . 本機は、公道を走行するためには、道路法による特殊車両の通行許可が必要です。基本通行条件 重量：C が記載された適合証明書を取得していますが、実際の通行経路で申請して許可された条件で走行しなければなりません。
- 3 . 本機は、公道を走行するためには、道路運送車両の保安基準による保安基準緩和の認定が必要です。

2 . E S P ブーム定格総荷重表

- 1 . 定格総荷重は、アウトリガを水平堅土上に設置したときの値で、太線より上側はクレーンの強度に基づき、下側は、クレーンの安定に基づいています。
- 2 . 定格総荷重表の性能区分 A ~ T は、下表のとおりです。

アウトリガ 張出幅 \ カウン タ ウ イ ト	71 t	47 t	35 t	23.5 t	12 t	0 t
8.3 m	A	B	C	D	E	F
7.0 m	G	H	I	J	K	L
5.6 m			M	N	O	P
4.6 m					Q	R
2.74m						S, T

同じ性能区分・ブーム長さでも、ブームの伸長状態によって定格総荷重が異なります。

S , T 性能の作業領域は右図のようになります。

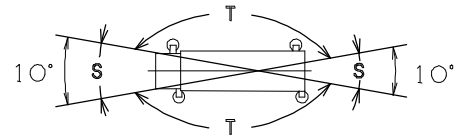

- 3 . 定格総荷重は、つり具質量とフック質量（125 t アタッチメントシーブ付フック：1,425kg、125 t フック：1,350kg、80 t フック：1,150kg、25 t フック：450kg、7.8 t フック：300kg）を含んだ値を示します。
- 4 . 定格総荷重は、ブームのたわみを含んだ実際の作業半径に基づいています。
- 5 . 各ブーム長さにおける標準フックとワイヤロープ標準巻掛本数は、ブームの各定格総荷重表中最下段に記載しています。ただし、この掛数以外で使用する場合は、ロープ 1 本当りの荷重は、主巻は 7.3 t 以下、補巻は 7.8 t 以下としてください。
シングルトップ使用時の巻掛本数は 1（7.8 t フック使用）です。
- 6 . シングルトップの定格総荷重は、ブームの定格総荷重からブームに取り付けられているフックの質量を差し引いた値とし、かつ限度は 7.8 t です。
- 7 . 定格総荷重表は、風による影響を含んでいません。瞬間最大風速が 10m / s 以上の風速では、クレーン作業を中止してください。
- 8 . 定格総荷重表中の は、無負荷時のブーム起伏角度範囲です。

定格総荷重表

A性能

7段ESPブーム

(単位: t)

性能ブロック	1	1	10	1	10	2	1	10	11	2	1	11	12	2	1	12	13	2	1	13	2	1	14	2	3	1	5	4	1	6	4	1	7	8	1	8	1	1	9		
性能番号	1	1	29	2	30	14	3	31	32	15	4	33	34	16	5	35	36	17	6	37	18	7	38	19	20	8	23	21	9	24	22	10	25	26	11	27	12	13	28		
ブーム長さ(m)		13.2	17.4	17.4	21.6	21.6	21.6	25.8	25.8	30.0	30.0	30.0	30.0	34.1	34.1	34.1	34.1	38.3	38.3	38.3	42.5	42.5	42.5	42.5	46.7	46.7	46.7	50.9	50.9	50.9	55.0	55.0	55.0	59.2	59.2	63.4	68.0				
作業半径(m)																																									
2.5	220.0																																								
3.0	180.0	175.2	108.0	60.3	108.0	63.9	45.8	94.0	94.0	65.0	47.2																														
3.5	169.5	158.5	108.0	56.9	108.0	61.0	43.0	94.0	94.0	62.4	44.6	80.0	77.5	63.0	40.4																										
4.0	160.0	144.2	108.0	53.9	108.0	58.3	40.5	94.0	94.0	60.0	42.4	80.0	77.5	60.8	38.6																										
4.5	150.5	132.1	108.0	51.2	108.0	56.0	38.3	94.0	94.0	57.7	40.3	80.0	77.5	58.8	36.9	70.0	58.0	51.0	35.0																						
5.0	135.5	121.6	108.0	48.8	108.0	53.7	36.1	94.0	94.0	55.7	38.4	80.0	77.5	56.9	35.3	70.0	58.0	51.0	33.7	54.5	43.5	30.0																			
6.0	112.5	104.4	104.4	44.6	103.8	49.9	32.4	83.8	94.0	52.1	35.2	79.2	77.5	53.5	31.8	70.0	58.0	51.0	32.1	54.5	43.5	30.0	43.5	37.6	31.5	25.5															
7.0	96.3	91.0	91.0	41.1	90.3	46.6	29.3	74.9	90.9	48.9	32.0	70.6	77.5	50.5	28.5	66.2	58.0	51.0	30.0	54.5	43.5	28.5	43.5	37.6	31.5	25.5	34.5	25.3	21.4												
8.0	83.6	80.3	80.2	38.1	79.5	42.8	26.8	67.5	80.1	46.2	29.1	63.6	77.5	47.9	25.8	61.0	58.0	49.3	28.0	54.5	43.5	27.5	43.5	37.6	31.5	25.5	34.5	25.3	21.4	28.5	22.6	18.9									
9.0	73.4	71.6	71.4	35.6	70.7	39.4	24.6	61.4	71.3	43.8	26.6	57.7	72.1	45.5	23.5	55.3	58.0	47.1	26.2	52.0	43.5	26.0	43.4	37.6	31.5	25.1	34.5	25.3	21.4	28.5	22.6	18.9	23.0	19.2	16.9						
10.0	65.3	63.5	64.1	33.5	63.4	36.4	22.8	56.2	64.0	41.6	24.6	52.7	64.8	43.5	21.6	50.5	58.0	45.0	24.5	48.8	43.5	24.7	41.4	37.6	31.0	24.5	34.5	24.7	21.4	28.5	22.6	18.9	23.0	19.2	16.9	18.8	15.0				
11.0			57.9	31.6	57.2	33.9	21.2	51.7	57.8	39.1	22.8	48.4	58.6	41.6	19.9	46.4	56.7	43.2	22.7	44.9	43.5	23.2	39.4	37.6	29.7	23.5	34.1	23.6	21.4	28.5	22.6	18.9	23.0	19.2	16.9	18.8	15.0	15.0			
12.0			52.6	30.1	51.8	31.8	19.9	47.8	52.3	36.5	21.2	44.7	53.0	39.9	18.5	42.8	54.0	41.6	21.1	41.5	42.8	21.5	37.6	37.6	28.4	22.5	32.6	22.8	21.4	28.3	22.6	18.9	23.0	19.2	16.9	18.8	15.0	15.0	13.8		
14.0			43.8	27.7	43.1	28.2	17.6	41.4	43.6	32.1	18.7	38.6	44.3	36.4	16.2	36.9	45.1	38.7	18.5	36.0	40.0	18.7	33.9	34.9	26.8	20.2	30.0	21.5	20.4	26.8	21.4	18.9	22.8	19.2	16.9	18.8	15.0	15.0	13.8		
16.0					36.5	25.4	15.8	35.8	37.0	28.7	16.7	33.8	37.6	33.0	14.3	32.3	38.4	35.4	16.4	31.5	37.3	16.5	29.6	30.7	24.7	18.3	28.5	19.9	18.8	24.9	20.1	18.4	21.8	19.2	16.9	18.8	15.0	15.0	13.8		
18.0					31.4	23.2	14.4	30.6	31.8	25.9	15.0	29.9	32.4	29.9	12.8	28.5	33.2	32.7	14.7	27.9	34.0	14.7	26.2	27.3	22.9	16.5	25.8	18.6	16.8	23.1	18.9	16.9	20.4	18.6	16.9	18.3	15.0	15.0	13.4		
20.0								25.8	27.1	23.6	13.7	26.4	27.8	27.3	11.6	25.4	28.7	30.3	13.3	24.9	29.6	13.2	23.3	24.4	21.4	14.9	23.0	17.4	15.1	21.5	17.7	15.4	19.1	17.3	15.8	17.2	15.0	15.0	13.1		
22.0								22.0	23.3	21.5	12.7	22.5	23.9	25.1	10.5	22.8	24.7	26.3	12.2	22.3	25.6	11.9	21.0	22.1	20.0	13.5	20.7	16.4	13.6	19.9	16.8	13.9	17.8	16.2	14.7	16.2	14.9	14.8	12.8		
24.0										20.1	21.6	23.1	11.2	20.2	22.4	20.8	18.9	20.0	18.9	12.4	18.7	15.4	18.7	15.4	12.3	18.0	15.9	12.6	16.7	15.1	13.7	15.2	14.0	14.0	12.5						
26.0										16.9	18.3	21.0	8.9	17.6	19.0	20.5	10.4	18.3	19.8	9.9	17.2	18.3	17.6	11.3	17.0	14.4	11.2	16.3	15.0	11.4	15.7	14.1	12.6	14.4	13.2	13.3	12.2				
28.0																15.5	16.9	18.4	9.7	16.2	17.6	9.2	15.7	16.7	16.5	10.5	15.6	13.4	10.3	14.9	14.3	10.5	14.5	12.9	11.5	13.6	12.4	12.6	11.4		
30.0																13.7	15.1	16.6	9.1	14.4	15.8	8.5	14.3	15.1	15.5	9.7	14.3	12.5	9.5	13.6	13.7	9.6	13.2	11.8	10.6	12.8	11.6	11.9	10.6		
32.0																				12.8	14.3	7.9	12.7	13.6	14.6	9.0	13.1	11.8	8.8	12.5	12.8	8.9	12.1	10.8	9.8	11.9	10.7	11.3	9.9		
34.0																						11.4	12.9	7.4	11.3	12.2	13.5	8.4	12.0	11.1	8.1	11.5	12.1	8.2	11.2	10.0	9.0	11.0	9.9	10.8	9.3
36.0																								10.1	11.0	12.3	7.9	10.8	10.5	7.5	10.6	11.4	7.6	10.3	9.2	8.3	10.2	9.1	10.0	8.7	
38.0																								9.0	9.9	11.3	7.5	9.7	9.9	7.0	9.8	10.8	7.1	9.5	8.5	7.7	9.4	8.5	9.3	8.2	
40.0																											8.7	9.5	6.6	8.8	9.9	6.6	8.8	7.9	7.1	8.7	7.9	8.7	7.7		
42.0																											7.9	9.1	6.2	7.9	9.0	6.2	8.2	7.4	6.6	8.1	7.3	8.1	7.3		
44.0																											5.5	6.5	5.9	7.2	8.3	5.8	7.4	6.9	6.1	7.5	6.8	7.5	6.8		
46.0																													6.5	7.6	5.4	6.7	6.4	5.7	7.0	6.4	7.0	6.4			
48.0																														5.4	5.9	5.1	6.0	6.0	5.3	6.4	6.0	6.5	6.1		
50.0																																									
52.0																																									
54.0																																									
56.0																																									
58.0																																									
60.0																																									
62.0																																									
64.0																																									
ピン無最大荷重	40.4	40.4	42.7	47.6	39.3	46.2	30.1	34.7	38.3	44.5	46.0	35.2	37.8	42.9	30.2	35.5	36.6	39.4	35.0	34.8	35.9	30.0	35.1	33.9	31.5	25.5	34.5	25.3	21.4	28.5	22.6	18.9	23.0	19.2	16.9	18.8	15.0	15.0	13.8		
(°)	0~84	0~84	0~84	0~84	0~84	0~84	0~84	0~84	0~84	0~84	0~84	0~84	0~84	0~84	0~84	0~84	0~84	0~84	0~84	0~84	0~84	0~84	0~84	0~84	0~84	0~84	0~84	0~84	0~84	0~84	0~84	0~84	0~84	0~84	0~84	0~84	0~84	0~84			
伸 長 状 態 (伸長割合%)																																									
伸縮ブーム1																																									

定格総荷重表

C性能

7段ESPブーム

(単位: t)

性能ブロック	1	1	10	1	10	2	1	10	11	2	1	11	12	2	1	12	13	2	1	13	2	1	14	2	3	1	5	4	1	6	4	1	7	8	1	8	1	1	9				
性能番号	1	1	29	2	30	14	3	31	32	15	4	33	34	16	5	35	36	17	6	37	18	7	38	19	20	8	23	21	9	24	22	10	25	26	11	27	12	13	28				
ブーム長さ(m)		13.2	17.4	17.4	21.6	21.6	21.6	25.8	25.8	25.8	30.0	30.0	30.0	30.0	34.1	34.1	34.1	34.1	38.3	38.3	38.3	42.5	42.5	42.5	42.5	46.7	46.7	46.7	50.9	50.9	50.9	55.0	55.0	55.0	59.2	59.2	63.4	68.0					
作業半径(m)																																											
2.5	220.0																																										
3.0	180.0	162.8	108.0	60.3	108.0	63.9	45.8	94.0	94.0	65.0	47.2																																
3.5	167.9	146.3	108.0	56.9	108.0	61.0	43.0	94.0	94.0	62.4	44.6	80.0	77.5	63.0	40.4																												
4.0	147.2	132.4	108.0	53.9	108.0	58.3	40.5	94.0	94.0	60.0	42.4	80.0	77.5	60.8	38.6																												
4.5	130.9	120.5	108.0	51.2	108.0	56.0	38.3	94.0	94.0	57.7	40.3	80.0	77.5	58.8	36.9	70.0	58.0	51.0	35.0																								
5.0	117.7	110.3	108.0	48.8	108.0	53.7	36.1	94.0	94.0	55.7	38.4	80.0	77.5	56.9	35.3	70.0	58.0	51.0	33.7	54.5	43.5	30.0																					
6.0	96.7	93.7	93.8	44.6	93.1	49.9	32.4	83.8	93.7	52.1	35.2	79.2	77.5	53.5	31.8	70.0	58.0	51.0	32.1	54.5	43.5	30.0	43.5	37.6	31.5	25.5																	
7.0	81.5	80.9	80.9	41.1	80.2	46.6	29.3	74.9	80.8	48.9	32.0	70.6	77.5	50.5	28.5	66.2	58.0	51.0	30.0	54.5	43.5	28.5	43.5	37.6	31.5	25.5	34.5	25.3	21.4														
8.0	70.2	70.2	70.1	38.1	69.5	42.8	26.8	67.5	70.0	46.2	29.1	63.6	70.8	47.9	25.8	61.0	58.0	49.3	28.0	54.5	43.5	27.5	43.5	37.6	31.5	25.5	34.5	25.3	21.4	28.5	22.6	18.9											
9.0	61.3	61.3	61.2	35.6	60.5	39.4	24.6	59.7	61.1	43.8	26.6	57.7	61.8	45.5	23.5	55.3	58.0	47.1	26.2	52.0	43.5	26.0	43.4	37.6	31.5	25.1	34.5	25.3	21.4	28.5	22.6	18.9	23.0	19.2	16.9								
10.0	52.7	52.7	52.3	33.5	51.4	36.4	22.8	50.3	52.1	41.6	24.6	51.3	53.2	43.5	21.6	50.5	54.4	45.0	24.5	48.8	43.5	24.7	41.4	37.6	31.0	24.5	34.5	24.7	21.4	28.5	22.6	18.9	23.0	19.2	16.9	18.8	15.0						
11.0			44.1	31.6	43.3	33.9	21.2	42.2	44.0	39.1	22.8	43.1	45.0	41.6	19.9	44.1	46.1	43.2	22.7	44.9	43.5	23.2	39.4	37.6	29.7	23.5	34.1	23.6	21.4	28.5	22.6	18.9	23.0	19.2	16.9	18.8	15.0	15.0					
12.0			37.9	30.1	37.1	31.8	19.9	36.1	37.7	36.5	21.2	36.9	38.7	39.9	18.5	37.8	39.8	41.6	21.1	38.9	40.9	21.5	37.6	37.6	28.4	22.5	32.6	22.8	21.4	28.3	22.6	18.9	23.0	19.2	16.9	18.8	15.0	15.0	13.8				
14.0			29.1	27.7	28.2	28.2	17.6	27.3	28.8	32.1	18.7	28.1	29.7	32.9	16.2	28.9	30.7	32.5	18.5	29.9	31.7	18.7	29.8	31.0	26.8	20.2	30.0	21.5	20.4	26.8	21.4	18.9	22.8	19.2	16.9	18.8	15.0	15.0	13.8				
16.0					22.2	25.4	15.8	21.3	22.8	26.9	16.7	22.1	23.6	26.7	14.3	22.8	24.5	26.3	16.4	23.8	25.5	16.5	23.7	24.8	24.7	18.3	24.7	19.9	18.8	24.9	20.1	18.4	21.8	19.2	16.9	18.8	15.0	15.0	13.8				
18.0					17.9	22.1	14.4	17.0	18.4	22.4	15.0	17.7	19.2	22.2	12.8	18.4	20.1	21.7	14.7	19.3	21.0	14.7	19.3	20.3	21.8	16.5	20.2	18.6	16.8	20.4	18.9	16.9	20.4	18.6	16.9	18.3	15.0	15.0	13.4				
20.0								13.8	15.2	19.0	13.7	14.4	15.9	18.7	11.6	15.1	16.7	18.3	13.3	16.0	17.6	13.2	15.9	16.9	18.4	14.9	16.8	17.4	15.1	17.0	17.7	15.4	17.2	17.3	15.8	17.2	15.0	15.0	13.1				
22.0										11.4	12.6	16.3	12.7	11.9	13.3	16.1	10.5	12.5	14.1	15.7	12.2	13.4	14.9	11.9	13.3	14.3	15.7	13.5	14.2	16.1	13.6	14.3	15.4	13.9	14.6	15.5	14.7	14.9	14.8	12.8			
24.0																																											
26.0																																											
28.0																																											
30.0																																											
32.0																																											
34.0																																											
36.0																																											
38.0																																											
40.0																																											
42.0																																											
44.0																																											
46.0																																											
48.0																																											
50.0																																											
52.0																																											
54.0																																											
56.0																																											
58.0																																											
60.0																																											
62.0																																											
64.0																																											
ピン無最大荷重	40.4	40.4	42.7	47.6	39.3	46.2	30.1	34.7	38.3	44.5	46.0	35.2	37.8	42.9	30.2	35.5	36.6	39.4	35.0	34.8	35.9	30.0	35.1	33.9	31.5	25.5	34.5	25.3	21.4	28.5	22.6	18.9	23.0	19.2	16.9	18.8	15.0	15.0	13.8				
()	0-84	0-84	0-84	0-84	0-84	0-84	0-84	0-84	0-84	0-84	0-84	0-84	0-84	0-84	0-84	0-84	0-84	0-84	0-84	0-84	0-84	0-84	0-84	0-84	0-84	0-84	0-84	0-84	0-84	0-84	0-84	0-84	0-84	0-84	0-84	0-84	0-84	0-84	0-84	0-84			
伸 長 状 態 (伸長割合%)																																											
伸縮ブーム1	0	0	0	0	46	0	0	92	46	0	0	92	46	0	0	92	46	0	0	92	46	0	92	92	46	0	92	46	0	92	92	0	92	46	0	92	46	92	100				
伸縮ブーム2	0	0	46	0	46	0	0	46	46	0	0	46	46	0	0	46	46	46	0	46	46	0	92	46	46	0	92	46	0	92	46	46	92	46	46	92	92	92	92	100			
伸縮ブーム3	0	0	0	0	0	0	0	0	46	0	0	46	46	46	0	46	46	46	0	46	46	0	46	46	46	46	46																

定格総荷重表

E性能

7段ESPブーム

(単位: t)

性能ブロック	1	1	10	1	10	2	1	10	11	2	1	11	12	2	1	12	13	2	1	13	2	1	14	2	3	1	5	4	1	6	4	1	7	8	1	8	1	1	1	9	
性能番号	1	1	29	2	30	14	3	31	32	15	4	33	34	16	5	35	36	17	6	37	18	7	38	19	20	8	23	21	9	24	22	10	25	26	11	27	12	13	28		
ブーム長さ(m)	13.2		17.4	17.4	21.6	21.6	21.6	25.8	25.8	25.8	30.0	30.0	30.0	30.0	34.1	34.1	34.1	34.1	38.3	38.3	38.3	42.5	42.5	42.5	42.5	46.7	46.7	46.7	50.9	50.9	50.9	55.0	55.0	55.0	59.2	59.2	63.4	68.0			
作業半径(m)	220.0																																								
3.0	175.4	153.2	108.0	60.3	108.0	63.9	45.8	94.0	94.0	65.0	47.2																														
3.5	151.0	136.8	108.0	56.9	108.0	61.0	43.0	94.0	94.0	62.4	44.6	80.0	77.5	63.0	40.4																										
4.0	132.3	123.0	108.0	53.9	108.0	58.3	40.5	94.0	94.0	60.0	42.4	80.0	77.5	60.8	38.6																										
4.5	116.6	111.3	108.0	51.2	108.0	56.0	38.3	94.0	94.0	57.7	40.3	80.0	77.5	58.8	36.9	70.0	58.0	51.0	35.0																						
5.0	103.9	101.3	101.4	48.8	100.7	53.7	36.1	94.0	94.0	55.7	38.4	80.0	77.5	56.9	35.3	70.0	58.0	51.0	33.7	54.5	43.5	30.0																			
6.0	85.0	85.0	85.1	44.6	84.4	49.9	32.4	83.6	85.0	52.1	35.2	79.2	77.5	53.5	31.8	70.0	58.0	51.0	32.1	54.5	43.5	30.0	43.5	37.6	31.5	25.5															
7.0	68.2	68.2	68.2	41.1	67.0	46.6	29.3	65.5	68.1	48.9	32.0	66.9	69.6	50.5	28.5	66.2	58.0	51.0	30.0	54.5	43.5	28.5	43.5	37.6	31.5	25.5	34.5	25.3	21.4												
8.0	51.2	51.2	51.0	38.1	50.0	42.8	26.8	48.7	50.9	46.2	29.1	49.9	52.2	47.9	25.8	51.1	53.6	49.3	28.0	52.6	43.5	27.5	43.5	37.6	31.5	25.5	34.5	25.3	21.4	28.5	22.6	18.9									
9.0	40.4	40.4	40.1	35.6	39.1	39.4	24.6	38.0	40.0	43.8	26.6	39.1	41.1	45.3	23.5	40.1	42.4	44.8	26.2	41.5	43.5	26.0	41.4	37.6	31.5	25.1	34.5	25.3	21.4	28.5	22.6	18.9	23.0	19.2	16.9						
10.0	33.0	33.0	32.6	33.5	31.7	36.4	22.8	30.6	32.4	37.6	24.6	31.6	33.5	37.4	21.6	32.6	34.7	36.9	24.5	33.8	36.0	24.7	33.7	35.1	31.0	24.5	34.5	24.7	21.4	28.5	22.6	18.9	23.0	19.2	16.9	18.8	15.0				
11.0			27.0	30.1	26.2	31.4	21.2	25.1	26.9	31.8	22.8	26.1	27.9	31.5	19.9	27.0	29.0	31.1	22.7	28.2	30.2	23.2	28.1	29.4	29.7	23.5	29.2	23.6	21.4	28.5	22.6	18.9	23.0	19.2	16.9	18.8	15.0	15.0			
12.0			22.6	25.7	21.7	27.0	19.9	20.6	22.4	27.3	21.2	21.6	23.5	27.1	18.5	22.6	24.6	26.6	21.1	23.7	25.8	21.5	23.7	25.0	26.8	22.5	24.9	22.8	21.4	25.1	22.6	18.9	23.0	19.2	16.9	18.8	15.0	15.0	13.8		
14.0			16.3	19.1	15.4	20.3	17.6	14.4	16.0	20.7	18.7	15.2	17.0	20.4	16.2	16.1	18.0	20.0	18.5	17.2	19.1	18.7	17.1	18.3	20.1	20.2	18.2	20.7	20.4	18.4	19.8	18.9	18.8	19.2	16.9	18.8	15.0	15.0	13.8		
16.0					11.2	15.8	15.8	10.3	11.8	16.1	16.7	11.1	12.7	15.9	14.3	11.9	13.7	15.5	16.4	12.9	14.7	16.5	12.8	13.9	15.6	17.5	13.8	16.1	17.2	14.0	15.3	16.9	14.3	15.4	16.4	14.7	15.0	15.0	13.8		
18.0					8.3	12.7	12.9	7.2	8.8	13.0	13.7	8.0	9.6	12.7	12.8	8.9	10.6	12.3	14.3	9.8	11.5	14.2	9.7	10.8	12.4	14.2	10.7	12.9	13.9	10.9	12.1	13.6	11.2	12.2	13.1	11.6	12.6	12.0	12.0		
20.0							4.7	6.5	10.6	11.3	5.5	7.4	10.4	11.6	6.5	8.3	9.9	11.8	7.5	9.2	11.8	7.5	8.5	10.0	11.8	8.4	10.5	11.4	8.6	9.7	11.1	8.8	9.8	10.7	9.2	10.2	9.6	9.6			
22.0								2.9	4.6	8.8	9.5	3.6	5.4	8.6	9.7	4.5	6.5	8.1	9.9	5.6	7.4	9.9	5.5	6.7	8.1	9.9	6.6	8.6	9.6	6.7	7.9	9.3	7.0	7.9	8.8	7.4	8.4	7.8	7.7		
24.0												2.1	3.9	7.1	8.2	2.9	4.9	6.7	8.4	4.0	5.9	8.4	3.9	5.1	6.7	8.3	4.9	7.1	8.0	5.1	6.4	7.8	5.4	6.5	7.3	5.9	6.9	6.3	6.3		
26.0													2.6	6.0	7.1	1.7	3.6	5.5	7.2	2.7	4.6	7.1	2.5	3.7	5.5	7.1	3.6	5.9	6.8	3.8	5.2	6.5	4.1	5.2	6.1	4.5	5.7	5.0	5.0		
28.0																2.5	4.4	6.2		3.5	6.1		2.6	4.4	6.1	2.5	4.9	5.8		4.0	5.5		4.1	5.1	3.4	4.5	3.9				
30.0																	3.5	5.4			2.6	5.3		1.7	3.4	5.2		3.9	4.9		3.1	4.6		3.1	4.1		3.6				
32.0																					1.8	4.5			2.6	4.5		3.1	4.1		2.2	3.8		2.3	3.3		2.8				
34.0																						3.9			1.9	3.8		2.4	3.4			3.1			2.6						
36.0																									3.2		1.7	2.8			2.5			1.9							
38.0																									2.7			2.3			1.9										
40.0																													1.8												
42.0																																									
44.0																																									
46.0																																									
48.0																																									
50.0																																									
52.0																																									
54.0																																									
56.0																																									
ピン無最大荷重 (t)	40.4	40.4	42.7	47.6	39.3	46.2	30.1	34.7	38.3	44.5	46.0	35.2	37.8	42.9	30.2	35.5	36.6	39.4	35.0	34.8	35.9	30.0	35.1	33.9	31.5	25.5	34.5	25.3	21.4	28.5	22.6	18.9	23.0	19.2	16.9	18.8	15.0	15.0	13.8		
	0~84	0~84	0~84	0~84	0~84	0~84	0~84	0~84	0~84	0~84	0~84	0~84	0~84	0~84	0~84	37~84	0~84	0~84	0~84	45~84	0~84	0~84	52~84	44~84	0~84	0~84	53~84	38~84	0~84	60~84	51~84	41~84	63~84	55~84	50~84	64~84	59~84	66~84	71~84		
伸 長 状 態 (伸長割合%)																																									
伸縮ブーム1	0	0	0	0	46	0	0	92	46	0	0	92	46	0	0	92	46	0	0	92	46	0	92	92	46	0	92	46	0	92	92	0	92	46	0	92	46	92	100		
伸縮ブーム2	0	0	46	0	46	0	0	46	46	0	0	46	46	0	0	46	46	46	0	46	46	0	92	46	46	0	92	46	0	92	46	46	92	92	92	92	92	92	100		
伸縮ブーム3	0	0	0	0	0	0	0	0	46	0	0	46	46	46	0	46	46	46	0	46	46	0	46	46	46	46	46	46	92	92	46	46	92	92	92	92	92	92	100		
伸縮ブーム4	0	0	0	0	0	0	0	0	46	0	0	46	46	46	0	46	46	46	46	46	46	92	46	46	46	92	46	92	92	46	46	92	92	92	92	92	92	92	100		
伸縮ブーム5	0	0	0	0	0	46	0	0	0	46	46	0	0	46	92	0	46	46	92	46	46	92	46	46	92	46	92	46	92	92	46	92	92	92	92	92	92	92	100		
伸縮ブーム6	0	0	0	46	0	46	92	0	0	46	92	0	0	46																											

定格総荷重表

F 性能

7段ESPブーム

(単位: t)

性能ブロック	1	1	10	1	10	2	1	10	11	2	1	11	12	2	1	12	13	2	1	13	2	1	14	2	3	1	5	4	1	6	4	1	7	8	1		
性能番号	1	1	29	2	30	14	3	31	32	15	4	33	34	16	5	35	36	17	6	37	18	7	38	19	20	8	23	21	9	24	22	10	25	26	11		
ブーム長さ(m)		13.2	17.4	17.4	21.6	21.6	21.6	25.8	25.8	25.8	25.8	30.0	30.0	30.0	30.0	34.1	34.1	34.1	34.1	38.3	38.3	38.3	42.5	42.5	42.5	42.5	46.7	46.7	46.7	50.9	50.9	50.9	55.0	55.0	55.0		
作業半径(m)																																					
2.5	220.0																																				
3.0	180.0	148.6	108.0	60.3	108.0	63.9	45.8	94.0	94.0	65.0	47.2																										
3.5	167.1	132.3	108.0	56.9	108.0	61.0	43.0	94.0	94.0	62.4	44.6	80.0	77.5	63.0	40.4																						
4.0	142.7	118.6	108.0	53.9	108.0	58.3	40.5	94.0	94.0	60.0	42.4	80.0	77.5	60.8	38.6																						
4.5	124.2	107.0	107.0	51.2	106.4	56.0	38.3	94.0	94.0	57.7	40.3	80.0	77.5	58.8	36.9	70.0	58.0	51.0	35.0																		
5.0	109.7	95.9	95.9	48.8	95.3	53.7	36.1	94.0	94.0	55.7	38.4	80.0	77.5	56.9	35.3	70.0	58.0	51.0	33.7	54.5	43.5	30.0															
6.0	78.2	77.7	77.7	44.6	76.8	49.9	32.4	75.1	77.7	52.1	35.2	76.7	77.5	53.5	31.8	70.0	58.0	51.0	32.1	54.5	43.5	30.0	43.5	37.6	31.5	25.5											
7.0	53.4	53.4	53.3	41.1	52.1	46.6	29.3	50.7	53.2	48.9	32.0	52.1	54.7	50.5	28.5	53.4	56.3	51.0	30.0	54.5	43.5	28.5	43.5	37.6	31.5	25.5	34.5	25.3	21.4								
8.0	39.6	39.6	39.4	38.1	38.4	42.8	26.8	37.2	39.3	45.5	29.1	38.3	40.6	45.2	25.8	39.5	42.1	44.7	28.0	41.0	43.5	27.5	40.9	37.6	31.5	25.5	34.5	25.3	21.4	28.5	22.6	18.9					
9.0	30.7	30.7	30.4	34.2	29.3	35.6	24.6	28.0	30.3	36.1	26.6	29.2	31.6	35.8	23.5	30.5	33.0	35.3	26.2	31.9	34.3	26.0	31.9	33.4	31.5	25.1	33.2	25.3	21.4	28.5	22.6	18.9	23.0	19.2	16.9		
10.0	24.1	24.1	23.6	27.3	22.6	28.8	22.8	21.5	23.5	29.3	24.6	22.6	24.7	29.0	21.6	23.7	26.0	28.5	24.5	25.0	27.4	24.7	25.0	26.5	28.6	24.5	26.3	24.7	21.4	26.6	22.6	18.9	23.0	19.2	16.9		
11.0			18.9	22.2	17.9	23.7	21.2	16.9	18.7	24.1	22.8	17.9	19.8	23.8	19.9	18.9	21.1	23.3	22.7	20.1	22.4	23.2	20.1	21.5	23.5	23.5	21.3	23.6	21.4	21.6	22.6	18.9	21.9	19.2	16.9		
12.0			15.4	18.5	14.4	19.8	19.9	13.4	15.2	20.2	21.1	14.3	16.2	20.0	18.5	15.3	17.4	19.5	21.1	16.5	18.6	21.5	16.4	17.7	19.6	21.9	17.6	20.2	21.4	17.9	19.3	18.9	18.2	19.2	16.9		
14.0			10.5	13.3	9.6	14.5	14.8	8.6	10.3	14.9	15.7	9.5	11.2	14.7	16.1	10.4	12.3	14.2	16.4	11.4	13.4	16.4	11.4	12.6	14.3	16.3	12.4	14.9	16.0	12.7	14.0	15.7	13.0	14.1	15.1		
16.0					6.3	11.0	11.2	5.1	7.0	11.3	12.1	6.1	7.9	11.1	12.5	7.1	8.9	10.7	12.7	8.1	9.9	12.7	8.0	9.1	10.8	12.7	9.0	11.3	12.4	9.2	10.5	12.0	9.5	10.6	11.6		
18.0					3.7	8.6	8.7	2.6	4.4	8.8	9.6	3.5	5.4	8.6	9.9	4.4	6.5	8.2	10.1	5.6	7.4	10.1	5.5	6.7	8.3	10.1	6.6	8.8	9.8	6.8	8.0	9.5	7.1	8.1	9.0		
20.0									2.4	7.0	7.7		3.4	6.8	8.0		4.5	6.3	8.2	3.6	5.6	8.2		4.8	6.4	8.2	4.6	6.9	7.8	4.8	6.1	7.5		6.2	7.1		
22.0										5.6	6.3		1.9	5.4	6.5		2.9	4.9	6.7		4.0	6.7			4.9	6.7		5.4	6.4		4.6	6.1		4.7	5.6		
24.0														4.2	5.4			3.7	5.5		2.7	5.5			3.7	5.5		4.2	5.2			4.9		4.4			
26.0														3.2	4.4			2.6	4.6			4.5			2.6	4.5		3.1	4.2			3.8		3.3			
28.0																		1.8	3.8			3.7			3.7			2.2	3.3			2.9		2.2			
30.0																			3.1			3.0			2.9			2.5			2.2						
32.0																						2.3			2.2			1.9									
34.0																						1.8			1.7												
36.0																																					
38.0																																					
40.0																																					
42.0																																					
44.0																																					
46.0																																					
48.0																																					
50.0																																					
ピン無最大荷重	40.4	40.4	42.7	47.6	39.3	46.2	30.1	34.7	38.3	44.5	46.0	35.2	37.8	42.9	30.2	35.5	36.6	39.4	35.0	34.8	35.9	30.0	35.1	33.9	31.5	25.5	34.5	25.3	21.4	28.5	22.6	18.9	23.0	19.2	16.9		
(°)	0~84	0~84	0~84	0~84	0~84	0~84	0~84	41~84	0~84	0~84	0~84	50~84	39~84	0~84	0~84	56~84	48~84	0~84	0~84	57~84	50~84	0~84	65~84	62~84	51~84	0~84	65~84	52~84	46~84	68~84	65~84	54~84	72~84	68~84	63~84		
伸 長 状 態 (伸長割合%)																																					
伸縮ブーム1	0	0	0	0	46	0	0	92	46	0	0	92	46	0	0	92	46	0	0	92	46	0	92	92	46	0	92	46	0	92	92	0	92	46	0		
伸縮ブーム2	0	0	46	0	46	0	0	46	46	0	0	46	46	0	0	46	46	46	0	46	46	0	92	46	46	0	92	46	0	92	46	46	92	46	92	92	
伸縮ブーム3	0	0	0	0	0	0	0	0	46	0	0	46	46	46	0	46	46	46	0	46	46	0	46	46	46	46	46	46	92	92	46	92	46	92	92	92	
伸縮ブーム4	0	0	0	0	0	0	0	0	46	0	0	46	46	46	0	46	46	46	46	46	46	92	46	46	46	92	46	46	92	46	92	46	92	46	92	92	
伸縮ブーム5	0	0	0	0	0	46	0	0	46	46	0	0	46	92	0	46	46	92	46	46	92	46	46	46	92	46	92	46	92	46	92	46	92	46	92	92	
伸縮ブーム6	0	0	0	46	0	46	92	0	0	46	92	0	0	46	92	0	46	92	0	46	92	0	46	92	0	46	92	46	92	46	92	46	92	46	92	92	
標準フック	125t x 2	125t	80t	125t	80t	80t	125t	125t	80t	80t	80t	80t	80t	80t	80t	80t	80t	80t	80t	80t	80t	80t	80t	80t	80t	80t	80t	80t	80t	80t	80t	80t	80t	80t	80t	80t	
フック質量	1425kg x 2	1350kg	1150kg	1350kg	1150kg	1150kg	1350kg	1350kg	1150kg	1150kg	1150kg	1150kg	1150kg	1150kg	1150kg	1150kg	1150kg	1150kg	1150kg	1150kg	1150kg	1150kg	1150kg	1150kg	1150kg	1150kg	1150kg	1150kg	1150kg	1150kg	1150kg	1150kg	1150kg	1150kg	1150kg		
標準巻掛本数	19 x 2	15	9	15	9	7	13	13	10	7	11	11	9	6	10	9	8	5	8	7	5	8	7	5	7	6	5	4	5	4	4	4	4	4	4		

注) カウンタウエイト0t、アウトリガ張出幅 8.3m 印はアタッチメント付きの値です。 印は後方限定の値です。

定格総荷重表

G性能 7段ESPブーム

(単位: t)

性能ブロック	1	1	10	1	10	2	1	10	11	2	1	11	12	2	1	12	13	2	1	13	2	1	14	2	3	1	5	4	1	6	4	1	7	8	1	8	1	1	9	
性能番号	1	1	29	2	30	14	3	31	32	15	4	33	34	16	5	35	36	17	6	37	18	7	38	19	20	8	23	21	9	24	22	10	25	26	11	27	12	13	28	
ブーム長さ(m)		13.2		17.4	17.4	21.6	21.6	25.8	25.8	25.8	30.0	30.0	30.0	30.0	34.1	34.1	34.1	34.1	38.3	38.3	38.3	42.5	42.5	42.5	42.5	46.7	46.7	46.7	50.9	50.9	50.9	55.0	55.0	55.0	59.2	59.2	63.4	68.0		
作業半径(m)																																								
2.5	220.0																																							
3.0	180.0	170.8	108.0	60.3	108.0	63.9	45.8	94.0	94.0	65.0	47.2																													
3.5	169.5	153.8	108.0	56.9	108.0	61.0	43.0	94.0	94.0	62.4	44.6	80.0	77.5	63.0	40.4																									
4.0	160.0	139.5	108.0	53.9	108.0	58.3	40.5	94.0	94.0	60.0	42.4	80.0	77.5	60.8	38.6																									
4.5	150.5	127.3	108.0	51.2	108.0	56.0	38.3	94.0	94.0	57.7	40.3	80.0	77.5	58.8	36.9	70.0	58.0	51.0	35.0																					
5.0	135.5	116.9	108.0	48.8	108.0	53.7	36.1	94.0	94.0	55.7	38.4	80.0	77.5	56.9	35.3	70.0	58.0	51.0	33.7	54.5	43.5	30.0																		
6.0	112.5	99.9	99.9	44.6	99.3	49.9	32.4	83.8	94.0	52.1	35.2	79.2	77.5	53.5	31.8	70.0	58.0	51.0	32.1	54.5	43.5	30.0	43.5	37.6	31.5	25.5														
7.0	96.3	86.7	86.7	41.1	86.1	46.6	29.3	74.9	86.6	48.9	32.0	70.6	77.5	50.5	28.5	66.2	58.0	51.0	30.0	54.5	43.5	28.5	43.5	37.6	31.5	25.5	34.5	25.3	21.4											
8.0	83.6	76.3	76.2	38.1	75.5	42.8	26.8	67.5	76.1	46.2	29.1	63.6	76.9	47.9	25.8	61.0	58.0	49.3	28.0	54.5	43.5	27.5	43.5	37.6	31.5	25.5	34.5	25.3	21.4	28.5	22.6	18.9								
9.0	73.5	67.8	67.6	35.6	67.0	39.4	24.6	61.4	67.5	43.8	26.6	57.7	68.3	45.5	23.5	55.3	58.0	47.1	26.2	52.0	43.5	26.0	43.4	37.6	31.5	25.1	34.5	25.3	21.4	28.5	22.6	18.9	23.0	19.2	16.9					
10.0	65.4	60.9	60.6	33.5	59.9	36.4	22.8	56.2	60.4	41.6	24.6	52.7	61.2	43.5	21.6	50.5	58.0	45.0	24.5	48.8	43.5	24.7	41.4	37.6	31.0	24.5	34.5	24.7	21.4	28.5	22.6	18.9	23.0	19.2	16.9	18.8	15.0			
11.0			54.6	31.6	53.9	33.9	21.2	51.7	54.5	39.1	22.8	48.4	55.3	41.6	19.9	46.4	56.2	43.2	22.7	44.9	43.5	23.2	39.4	37.6	29.7	23.5	34.1	23.6	21.4	28.5	22.6	18.9	23.0	19.2	16.9	18.8	15.0	15.0		
12.0			49.6	30.1	48.9	31.8	19.9	47.8	49.4	36.5	21.2	44.7	50.2	39.9	18.5	42.8	51.1	41.6	21.1	41.5	42.8	21.5	37.6	37.6	28.4	22.5	32.6	22.8	21.4	28.3	22.6	18.9	23.0	19.2	16.9	18.8	15.0	15.0	13.8	
14.0			41.6	27.7	40.7	28.2	17.6	39.9	41.3	32.1	18.7	38.6	42.1	36.4	16.2	36.9	43.0	38.7	18.5	36.0	40.0	18.7	33.9	34.9	26.8	20.2	30.0	21.5	20.4	26.8	21.4	18.9	22.8	19.2	16.9	18.8	15.0	15.0	13.8	
16.0					33.9	25.4	15.8	33.0	34.5	28.7	16.7	33.7	35.3	33.0	14.3	32.3	36.2	35.4	16.4	31.5	37.2	16.5	29.6	30.7	24.7	18.3	28.5	19.9	18.8	24.9	20.1	18.4	21.8	19.2	16.9	18.8	15.0	15.0	13.8	
18.0					28.0	23.2	14.4	27.1	28.5	25.9	15.0	27.8	29.3	29.9	12.8	28.5	30.1	31.8	14.7	27.9	31.1	14.7	26.2	27.3	22.9	16.5	25.8	18.6	16.8	23.1	18.9	16.9	20.4	18.6	16.9	18.3	15.0	15.0	13.4	
20.0								22.7	24.0	23.6	13.7	23.3	24.7	27.3	11.6	24.0	25.6	27.2	13.3	24.9	26.5	13.2	23.3	24.4	21.4	14.9	23.0	17.4	15.1	21.5	17.7	15.4	19.1	17.3	15.8	17.2	15.0	15.0	13.1	
22.0								19.3	20.5	21.5	12.7	19.8	21.2	24.0	10.5	20.4	22.0	23.6	12.2	21.3	22.8	11.9	21.0	22.1	20.0	13.5	20.7	16.4	13.6	19.9	16.8	13.9	17.8	16.2	14.7	16.2	14.9	14.8	12.8	
24.0								17.0	18.3	21.1	9.7	17.6	19.1	20.6	11.2	18.4	19.9	10.8	11.2	18.4	19.9	10.8	18.3	19.3	18.9	12.4	18.7	15.4	12.3	18.0	15.9	12.6	16.7	15.1	13.7	15.2	14.0	14.0	12.5	
26.0												14.7	16.1	18.8	8.9	15.3	16.8	18.3	10.4	16.0	17.5	9.9	16.0	16.9	17.6	11.3	16.8	14.4	11.2	16.3	15.0	11.4	15.7	14.1	12.6	14.4	13.2	13.3	12.2	
28.0																																								
30.0																																								
32.0																																								
34.0																																								
36.0																																								
38.0																																								
40.0																																								
42.0																																								
44.0																																								
46.0																																								
48.0																																								
50.0																																								
52.0																																								
54.0																																								
56.0																																								
58.0																																								
60.0																																								
62.0																																								
64.0																																								
ピン無最大荷重	40.4	40.4	42.7	47.6	39.3	46.2	30.1	34.7	38.3	44.5	46.0	35.2	37.8	42.9	30.2	35.5	36.6	39.4	35.0	34.8	35.9	30.0	35.1	33.9	31.5	25.5	34.5	25.3	21.4	28.5	22.6	18.9	23.0	19.2	16.9	18.8	15.0	15.0	13.8	
(°)	0~84	0~84	0~84	0~84	0~84	0~84	0~84	0~84	0~84	0~84	0~84	0~84	0~84	0~84	0~84	0~84	0~84	0~84	0~84	0~84	0~84	0~84	0~84	0~84	0~84	0~84	0~84	0~84	0~84	0~84	0~84	0~84	0~84	0~84	0~84	0~84	0~84	0~84		
伸 長 状 態 (伸長割合%)																																								
伸縮ブーム1	0	0	0	0	46	0	0	92	46	0	0	92	46	0	0	92	46	0	0	92	46	0	92	92	46	0	92	46	0	92	92	0	92	46	0	92	46	92	100	
伸縮ブーム2	0	0	46	0	46	0	0	46	46	0	0	46	46	0	0	46	46	46	0	46	46	0	92	46	46	0	92	46	0	92	46	46	92	92	92	92	92	92	100	
伸縮ブーム3	0	0	0	0	0	0	0	0	46	0	0	46	46	46	0	46	46	46	0	46	46	0	46	46	46	46	46	46	92	92	46	46	92	92	92	92	92	100		
伸縮ブーム4	0	0	0	0	0	0	0	0	0	46	0	0	46	46	46	46</																								

定格総荷重表

I 性能

7段ESPブーム

(単位: t)

性能ブロック	1	1	10	1	10	2	1	10	11	2	1	11	12	2	1	12	13	2	1	13	2	1	14	2	3	1	5	4	1	6	4	1	7	8	1	8	1	1	9		
性能番号	1	1	29	2	30	14	3	31	32	15	4	33	34	16	5	35	36	17	6	37	18	7	38	19	20	8	23	21	9	24	22	10	25	26	11	27	12	13	28		
ブーム長さ(m)		13.2		17.4	17.4	21.6	21.6	25.8	25.8	25.8	30.0	30.0	30.0	30.0	34.1	34.1	34.1	34.1	34.1	38.3	38.3	38.3	42.5	42.5	42.5	42.5	46.7	46.7	46.7	50.9	50.9	50.9	55.0	55.0	55.0	59.2	59.2	63.4	68.0		
作業半径(m)																																									
2.5	220.0																																								
3.0	180.0	156.3	108.0	60.3	108.0	63.9	45.8	94.0	94.0	65.0	47.2																														
3.5	169.5	139.8	108.0	56.9	108.0	61.0	43.0	94.0	94.0	62.4	44.6	80.0	77.5	63.0	40.4																										
4.0	158.1	126.0	108.0	53.9	108.0	58.3	40.5	94.0	94.0	60.0	42.4	80.0	77.5	60.8	38.6																										
4.5	137.9	114.3	108.0	51.2	108.0	56.0	38.3	94.0	94.0	57.7	40.3	80.0	77.5	58.8	36.9	70.0	58.0	51.0	35.0																						
5.0	122.0	104.3	104.4	48.8	103.7	53.7	36.1	94.0	94.0	55.7	38.4	80.0	77.5	56.9	35.3	70.0	58.0	51.0	33.7	54.5	43.5	30.0																			
6.0	98.7	88.1	88.2	44.6	87.5	49.9	32.4	83.8	88.1	52.1	35.2	79.2	77.5	53.5	31.8	70.0	58.0	51.0	32.1	54.5	43.5	30.0	43.5	37.6	31.5	25.5															
7.0	82.5	75.7	75.7	41.1	75.0	46.6	29.3	74.2	75.6	48.9	32.0	70.6	76.5	50.5	28.5	66.2	58.0	51.0	30.0	54.5	43.5	28.5	43.5	37.6	31.5	25.5	34.5	25.3	21.4												
8.0	68.3	66.0	65.9	38.1	65.2	42.8	26.8	64.3	65.8	46.2	29.1	63.6	66.6	47.9	25.8	61.0	58.0	49.3	28.0	54.5	43.5	27.5	43.5	37.6	31.5	25.5	34.5	25.3	21.4	28.5	22.6	18.9									
9.0	54.4	54.4	54.1	35.6	53.2	39.4	24.6	52.0	54.0	43.8	26.6	53.1	55.2	45.5	23.5	54.1	56.5	47.1	26.2	52.0	43.5	26.0	43.4	37.6	31.5	25.1	34.5	25.3	21.4	28.5	22.6	18.9	23.0	19.2	16.9						
10.0	44.8	44.8	44.4	33.5	43.5	36.4	22.8	42.4	44.3	41.6	24.6	43.4	45.3	43.5	21.6	44.4	46.6	45.0	24.5	45.6	43.5	24.7	41.4	37.6	31.0	24.5	34.5	24.7	21.4	28.5	22.6	18.9	23.0	19.2	16.9	18.8	15.0				
11.0			37.3	31.6	36.4	33.9	21.2	35.4	37.1	39.1	22.8	36.3	38.1	41.6	19.9	37.3	39.3	41.4	22.7	38.4	40.5	23.2	38.4	37.6	29.7	23.5	34.1	23.6	21.4	28.5	22.6	18.9	23.0	19.2	16.9	18.8	15.0	15.0			
12.0			31.9	30.1	31.0	31.8	19.9	30.0	31.7	36.4	21.2	30.9	32.7	36.1	18.5	31.8	33.7	35.7	21.1	32.9	34.9	21.5	32.8	34.1	28.4	22.5	32.6	22.8	21.4	28.3	22.6	18.9	23.0	19.2	16.9	18.8	15.0	15.0	13.8		
14.0			24.2	26.9	23.3	28.0	17.6	22.4	23.9	28.3	18.7	23.2	24.8	28.1	16.2	24.0	25.8	27.6	18.5	25.0	26.8	18.7	25.0	26.1	26.8	20.2	26.0	21.5	20.4	26.2	21.4	18.9	22.8	19.2	16.9	18.8	15.0	15.0	13.8		
16.0					18.1	22.5	15.8	17.2	18.7	22.8	16.7	18.0	19.5	22.6	14.3	18.7	20.4	22.2	16.4	19.7	21.4	16.5	19.6	20.7	22.3	18.3	20.6	19.9	18.8	20.8	20.1	18.4	21.1	19.2	16.9	18.8	15.0	15.0	13.8		
18.0					14.4	18.6	14.4	13.5	14.9	18.8	15.0	14.2	15.6	18.6	12.8	14.9	16.5	18.2	14.7	15.8	17.5	14.7	15.7	16.8	18.3	16.5	16.7	18.6	16.8	16.9	18.0	16.9	17.1	18.1	16.9	17.5	15.0	15.0	13.4		
20.0								10.7	12.0	15.9	13.7	11.3	12.8	15.6	11.6	12.0	13.6	15.2	13.3	12.9	14.5	13.2	12.8	13.8	15.3	14.9	13.7	15.7	15.1	13.9	15.0	15.4	14.1	15.1	15.8	14.5	15.0	14.9	13.1		
22.0								8.3	9.9	13.6	12.7	9.0	10.5	13.3	10.5	9.8	11.3	12.9	12.2	10.6	12.2	11.9	10.5	11.5	12.9	13.5	11.4	13.3	13.6	11.6	12.7	13.9	11.8	12.7	13.6	12.2	13.1	12.6	12.5		
24.0								7.0	8.7	11.5	9.7	7.8	9.5	11.0		7.0	8.8	10.3	10.8	10.8	8.7	9.6	11.0	12.4	9.5	11.4	12.3	9.7	10.8	12.1	9.9	10.8	12.7	11.6	10.3	11.2	10.7	10.6			
26.0										5.4	7.1	10.0	8.9	6.2	8.0	9.5	10.4	7.2	8.8	9.9	7.0	8.1	9.5	11.1	8.0	9.9	10.8	8.1	9.2	10.5	8.4	9.3	10.1	8.7	9.6	9.1	9.1				
28.0														4.8	6.6	8.2	9.7	5.7	7.5	9.2	5.6	6.8	8.2	9.7	6.6	8.6	9.4	6.8	7.9	9.2	7.1	8.0	8.8	7.4	8.3	7.8	7.8				
30.0														3.7	5.5	7.2	8.8			4.6	6.4	8.5	4.4	5.5	7.1	8.6	5.4	7.5	8.3	5.5	6.8	8.1	5.8	6.9	7.7	6.3	7.2	6.7	6.7		
32.0																				3.6	5.4	7.7	3.4	4.5	6.1	7.7	4.3	6.5	7.4	4.5	5.8	7.1	4.8	5.8	6.7	5.2	6.3	5.7	5.6		
34.0																				2.7	4.5	6.9	2.5	3.6	5.2	6.8	3.4	5.7	6.5	3.6	4.9	6.3	3.9	4.9	5.9	4.3	5.4	4.7	4.7		
36.0																						1.8	2.8	4.4	6.1	2.6	4.9	5.8	2.8	4.1	5.6	3.1	4.1	5.1	3.5	4.6	3.9	3.9			
38.0																								2.2	3.8	5.5	1.9	4.2	5.2	2.1	3.3	4.9	2.3	3.4	4.4	2.7	3.8	3.2	3.2		
40.0																													3.5	4.6											
42.0																													3.0	4.0											
44.0																													2.5	3.6											
46.0																																									
48.0																																									
50.0																																									
52.0																																									
54.0																																									
56.0																																									
58.0																																									
60.0																																									
62.0																																									
64.0																																									
ピン無最大荷重 (t)	40.4	40.4	42.7	47.6	39.3	46.2	30.1	34.7	38.3	44.5	46.0	35.2	37.8	42.9	30.2	35.5	36.6	39.4	35.0	34.8	35.9	30.0	35.1	33.9	31.5	25.5	34.5	25.3	21.4	28.5	22.6	18.9	23.0	19.2	16.9	18.8	15.0	15.0	13.8		
(°)	0~84	0~84	0~84	0~84	0~84	0~84	0~84	0~84	0~84	0~84	0~84	0~84	0~84	0~84	0~84	0~84	0~84	0~84	0~84	0~84	0~84	0~84	0~84	0~84	0~84	0~84	0~84	0~84	0~84	41~84	0~84	0~84	43~84	0~84	0~84	49~84	34~84	50~84	55~84		
伸 長 状 態 (伸長割合%)																																									
伸縮ブーム1	0	0	0	0	46	0	0	92	46	0	0	92	46	0	0	92	46	0	0	92	46	0	92	92	46	0	92	46	0	92	92	0	92	46	0	92	46	92	100		
伸縮ブーム2	0	0	46	0	46	0	0	46	46																																

定格総荷重表

J性能

7段ESPブーム

(単位: t)

性能番号	1	1	10	1	10	2	1	10	11	2	1	11	12	2	1	12	13	2	1	13	2	1	14	2	3	1	5	4	1	6	4	1	7	8	1	8	1	1	1	9					
ブーム長さ(m)	13.2		17.4	17.4	21.6	21.6	21.6	25.8	25.8	25.8	30.0	30.0	30.0	30.0	34.1	34.1	34.1	34.1	38.3	38.3	38.3	42.5	42.5	42.5	42.5	46.7	46.7	46.7	50.9	50.9	50.9	55.0	55.0	55.0	59.2	59.2	63.4	68.0							
作業半径(m)																																													
2.5	220.0																																												
3.0	180.0	151.0	108.0	60.3	108.0	63.9	45.8	94.0	94.0	65.0	47.2																																		
3.5	169.5	134.6	108.0	56.9	108.0	61.0	43.0	94.0	94.0	62.4	44.6	80.0	77.5	63.0	40.4																														
4.0	147.7	120.9	108.0	53.9	108.0	58.3	40.5	94.0	94.0	60.0	42.4	80.0	77.5	60.8	38.6																														
4.5	128.7	109.4	108.0	51.2	108.0	56.0	38.3	94.0	94.0	57.7	40.3	80.0	77.5	58.8	36.9	70.0	58.0	51.0	35.0																										
5.0	113.8	99.5	99.6	48.8	98.9	53.7	36.1	94.0	94.0	55.7	38.4	80.0	77.5	56.9	35.3	70.0	58.0	51.0	33.7	54.5	43.5	30.0																							
6.0	92.0	83.7	83.7	44.6	83.0	49.9	32.4	82.2	83.6	52.1	35.2	79.2	77.5	53.5	31.8	70.0	58.0	51.0	32.1	54.5	43.5	30.0	43.5	37.6	31.5	25.5																			
7.0	72.0	71.5	71.5	41.1	70.8	46.6	29.3	69.3	71.4	48.9	32.0	70.6	72.3	50.5	28.5	66.2	58.0	51.0	30.0	54.5	43.5	28.5	43.5	37.6	31.5	25.5	34.5	25.3	21.4																
8.0	54.1	54.1	53.9	38.1	52.9	42.8	26.8	51.6	53.8	46.2	29.1	52.8	55.1	47.9	25.8	54.0	56.5	49.3	28.0	54.5	43.5	27.5	43.5	37.6	31.5	25.5	34.5	25.3	21.4	28.5	22.6	18.9													
9.0	42.7	42.7	42.5	35.6	41.5	39.4	24.6	40.3	42.3	43.8	26.6	41.4	43.5	45.5	23.5	42.5	44.8	47.1	26.2	43.8	43.5	26.0	43.4	37.6	31.5	25.1	34.5	25.3	21.4	28.5	22.6	18.9	23.0	19.2	16.9										
10.0	35.0	35.0	34.6	33.5	33.7	36.4	22.8	32.6	34.4	39.6	24.6	33.6	35.5	39.4	21.6	34.6	36.7	38.9	24.5	35.8	38.0	24.7	35.7	37.1	31.0	24.5	34.5	24.7	21.4	28.5	22.6	18.9	23.0	19.2	16.9	18.8	15.0								
11.0			28.8	31.6	27.9	33.1	21.2	26.9	28.6	33.5	22.8	27.8	29.6	33.3	19.9	28.7	30.7	32.8	22.7	29.9	31.9	23.2	29.8	31.1	29.7	23.5	31.0	23.6	21.4	28.5	22.6	18.9	23.0	19.2	16.9	18.8	15.0	15.0							
12.0			24.4	27.3	23.5	28.5	19.9	22.5	24.2	28.8	21.2	23.4	25.1	28.6	18.5	24.3	26.2	28.2	21.1	25.4	27.3	21.5	25.3	26.5	28.3	22.5	26.4	22.8	21.4	26.6	22.6	18.9	23.0	19.2	16.9	18.8	15.0	15.0	13.8						
14.0			18.1	20.8	17.2	21.9	17.6	16.3	17.8	22.2	18.7	17.1	18.7	22.0	16.2	17.9	19.7	21.5	18.5	18.9	20.7	18.7	18.9	20.0	21.7	20.2	19.9	21.5	20.4	20.1	21.4	18.9	20.4	19.2	16.9	18.8	15.0	15.0	13.8						
16.0					13.0	17.4	15.8	12.1	13.6	17.7	16.7	12.8	14.4	17.5	14.3	13.6	15.3	17.0	16.4	14.6	16.3	16.5	14.5	15.6	17.1	18.3	15.5	17.6	18.6	15.7	16.9	18.3	15.9	16.9	16.3	15.0	15.0	13.8							
18.0					10.0	14.2	14.3	9.0	10.5	14.4	15.0	9.8	11.2	14.2	12.8	10.5	12.1	13.8	14.7	11.4	13.1	14.7	11.3	12.4	13.9	15.6	12.2	14.3	15.3	12.4	13.6	15.0	12.7	13.7	14.6	13.1	14.1	13.5	13.4						
20.0							6.4	8.1	12.0	12.6	7.2	8.9	11.7	11.6	8.1	9.7	11.3	13.1	9.0	10.6	13.1	8.9	9.9	11.4	13.1	9.8	11.8	12.8	10.0	11.1	12.5	10.3	11.2	12.1	10.6	11.6	11.0	11.0							
22.0							4.5	6.1	10.1	10.7	5.2	6.9	9.8	10.5	6.0	7.8	9.4	11.2	7.1	8.7	11.1	7.0	8.0	9.4	11.1	7.9	9.9	10.8	8.1	9.2	10.5	8.3	9.2	10.1	8.7	9.6	9.1	9.1							
24.0											3.5	5.3	8.3	9.4	4.4	6.3	7.9	9.6	5.4	7.2	9.5	5.3	6.5	7.9	9.5	6.3	8.3	9.2	6.5	7.6	8.9	6.8	7.7	8.5	7.1	8.1	7.5	7.5							
26.0											2.2	4.0	7.1	8.2	3.0	4.9	6.6	8.3	4.0	5.9	8.2	3.9	5.0	6.6	8.2	4.9	7.0	7.9	5.1	6.4	7.6	5.4	6.4	7.2	5.8	6.8	6.3	6.2							
28.0														1.9	3.7	5.6	7.2	2.8	4.7	7.2	2.7	3.8	5.5	7.1	3.7	6.0	6.8	3.9	5.2	6.6	4.2	5.2	6.1	4.6	5.7	5.1	5.0								
30.0															2.8	4.6	6.4	1.9	3.7	6.2	1.7	2.8	4.5	6.2	2.7	5.0	5.9	2.8	4.2	5.6	3.1	4.2	5.2	3.6	4.7	4.0	4.0								
32.0																				2.9	5.5		2.0	3.6	5.4	1.8	4.1	5.1	2.0	3.3	4.8	2.3	3.3	4.3	2.7	3.8	3.2	3.1							
34.0																					2.2	4.8			2.9	4.7		3.3	4.4		2.5	4.1		2.6	3.6		3.0								
36.0																								2.2	4.1		2.7	3.7		1.9	3.4		1.9	2.9		2.4									
38.0																								1.7	3.5		2.1	3.1			2.8			2.3		1.8									
40.0																													2.6						1.8										
42.0																																													
44.0																																													
46.0																																													
48.0																																													
50.0																																													
52.0																																													
54.0																																													
56.0																																													
58.0																																													
60.0																																													
62.0																																													
64.0																																													
ピン無最大荷重 (°)	0~84	0~84	0~84	0~84	0~84	0~84	0~84	0~84	0~84	0~84	0~84	0~84	0~84	0~84	0~84	0~84	0~84	0~84	0~84	0~84	0~84	0~84	0~84	0~84	0~84	0~84	0~84	0~84	0~84	0~84	0~84	0~84	0~84	0~84	0~84	0~84	0~84	0~84	0~84	0~84	0~84	0~84	0~84		
伸 長 状 態 (伸長割合%)																																													
伸縮ブーム1	0	0	0	0	46	0	0	92	46	0	0	92	46	0	0	92	46	0	0	92	46	0	92	92	46	0	92	46	0	92	92	0	92	46	0	92	46	0	92	46	92	100			
伸縮ブーム2	0	0	46	0	46	0																																							

定格総荷重表

L 性能

7段ESPブーム

(単位：t)

性能ブロック	1	1	10	1	10	2	1	10	11	2	1	11	12	2	1	12	13	2	1	13	2	1	14	2	3	1	5	4	1	4	
性能番号	1	1	29	2	30	14	3	31	32	15	4	33	34	16	5	35	36	17	6	37	18	7	38	19	20	8	23	21	9	22	
ブーム長さ(m)	13.2		17.4	17.4	21.6	21.6	21.6	25.8	25.8	25.8	25.8	30.0	30.0	30.0	30.0	34.1	34.1	34.1	34.1	38.3	38.3	38.3	42.5	42.5	42.5	42.5	46.7	46.7	46.7	50.9	
作業半径(m)																															
2.5	220.0																														
3.0	180.0	140.0	108.0	60.3	108.0	63.9	45.8	94.0	94.0	65.0	47.2																				
3.5	150.7	123.9	108.0	56.9	108.0	61.0	43.0	94.0	94.0	62.4	44.6	80.0	77.5	63.0	40.4																
4.0	128.7	110.5	108.0	53.9	108.0	58.3	40.5	94.0	94.0	60.0	42.4	80.0	77.5	60.8	38.6																
4.5	112.0	99.2	99.3	51.2	98.6	56.0	38.3	94.0	94.0	57.7	40.3	80.0	77.5	58.8	36.9	70.0	58.0	51.0	35.0												
5.0	98.9	89.6	89.7	48.8	89.0	53.7	36.1	88.1	89.6	55.7	38.4	80.0	77.5	56.9	35.3	70.0	58.0	51.0	33.7	54.5	43.5	30.0									
6.0	57.8	57.8	57.8	44.6	56.3	49.9	32.4	54.6	57.7	52.1	35.2	56.3	59.5	53.5	31.8	58.0	58.0	51.0	32.1	54.5	43.5	30.0	43.5	37.6	31.5	25.5					
7.0	38.7	38.7	38.6	41.1	37.5	45.1	29.3	36.1	38.5	45.6	32.0	37.4	40.0	45.3	28.5	38.8	41.7	44.7	30.0	40.5	43.4	28.5	40.4	37.6	31.5	25.5	34.5	25.3	21.4		
8.0	28.2	28.2	28.0	32.0	27.0	33.6	26.8	25.8	27.9	34.1	29.1	26.9	29.2	33.8	25.8	28.1	30.7	33.3	28.0	29.6	32.2	27.5	29.5	31.1	31.5	25.5	31.0	25.3	21.4	22.6	
9.0	21.5	21.5	21.3	24.8	20.3	26.3	24.6	19.2	21.2	26.7	26.6	20.3	22.3	26.5	23.5	21.3	23.6	26.0	26.2	22.7	25.0	26.0	22.6	24.0	26.1	25.1	23.9	25.3	21.4	22.6	
10.0	17.0	17.0	16.6	19.9	15.7	21.3	21.6	14.7	16.5	21.7	22.6	15.6	17.6	21.4	21.6	16.6	18.8	21.0	23.4	17.9	20.0	23.4	17.8	19.1	21.1	23.4	19.0	21.7	21.4	20.8	
11.0			13.2	16.3	12.3	17.6	17.9	11.4	13.1	17.9	18.8	12.3	14.1	17.7	19.3	13.2	15.2	17.3	19.6	14.4	16.4	19.6	14.3	15.5	17.4	19.6	15.4	18.0	19.2	17.1	
12.0			10.6	13.5	9.8	14.7	15.0	8.8	10.5	15.1	16.0	9.7	11.4	14.9	16.4	10.6	12.5	14.5	16.7	11.7	13.6	16.6	11.6	12.8	14.6	16.6	12.7	15.1	16.3	14.3	
14.0			7.0	9.6	6.0	10.7	11.0	4.8	6.7	11.1	11.8	5.8	7.6	10.9	12.2	6.8	8.6	10.4	12.5	7.8	9.6	12.5	7.8	8.9	10.5	12.4	8.8	11.0	12.1	10.3	
16.0				3.1	8.0	8.2			3.8	8.3	9.1		4.9	8.1	9.4		6.0	7.7	9.6	5.1	6.9	9.6		6.2	7.8	9.6	6.1	8.3	9.3	7.5	
18.0					6.1	6.3				6.4	7.0		2.7	6.1	7.4		3.8	5.7	7.6		5.0	7.6			5.8	7.5		6.3	7.2	5.5	
20.0										4.9	5.6			4.7	5.8			4.2	6.1		3.3	6.0			4.3	6.0		4.8	5.7		
22.0										3.7	4.4			3.4	4.7			2.9	4.8			4.8			2.9	4.8		3.4	4.5		
24.0														2.4	3.7			1.8	3.9			3.8			3.8		3.8		3.4		
26.0															2.8				3.0			2.9			2.9		2.9		2.5		
28.0																			2.3			2.2			2.1						
30.0																			1.7												
32.0																															
34.0																															
36.0																															
38.0																															
40.0																															
42.0																															
44.0																															
46.0																															
48.0																															
50.0																															
ピン無最大荷重	40.4	40.4	42.7	47.6	39.3	46.2	30.1	34.7	38.3	44.5	46.0	35.2	37.8	42.9	30.2	35.5	36.6	39.4	35.0	34.8	35.9	30.0	35.1	33.9	31.5	25.5	34.5	25.3	21.4	22.6	
(°)	0~84	0~84	0~84	0~84	0~84	0~84	0~84	54~84	48~84	0~84	0~84	60~84	50~84	0~84	0~84	64~84	57~84	42~84	0~84	65~84	57~84	41~84	71~84	68~84	58~84	48~84	71~84	61~84	56~84	70~84	
伸 長 状 態 (伸長割合%)																															
伸縮ブーム1	0	0	0	0	46	0	0	92	46	0	0	92	46	0	0	92	46	0	0	92	46	0	92	92	46	0	92	46	0	92	
伸縮ブーム2	0	0	46	0	46	0	0	46	46	0	0	46	46	0	0	46	46	46	0	46	46	0	92	46	46	0	92	46	0	46	
伸縮ブーム3	0	0	0	0	0	0	0	0	46	0	0	46	46	46	0	46	46	46	0	46	46	0	46	46	46	46	46	46	46	92	46
伸縮ブーム4	0	0	0	0	0	0	0	0	0	46	0	0	46	46	0	46	46	46	46	46	46	46	92	46	46	46	92	46	46	92	46
伸縮ブーム5	0	0	0	0	0	46	0	0	0	46	46	0	0	46	92	0	46	46	92	46	46	92	46	46	46	92	46	92	92	92	
伸縮ブーム6	0	0	0	46	0	46	92	0	0	46	92	0	0	46	92	0	0	46	92	0	46	92	0	46	92	0	46	92	92	92	
標準フック	125t×2	125t	80t	125t	80t	80t	125t	125t	80t	80t	80t	80t	80t	80t	80t	80t	80t	80t	80t	80t	80t	80t	80t	80t	80t	80t	80t	80t	80t	80t	
フック質量	1425kg×2	1350kg	1150kg	1350kg	1150kg	1150kg	1350kg	1350kg	1150kg	1150kg	1150kg	1150kg	1150kg	1150kg	1150kg	1150kg	1150kg	1150kg	1150kg	1150kg	1150kg	1150kg	1150kg	1150kg	1150kg	1150kg	1150kg	1150kg	1150kg		
標準巻掛本数	19×2	15	9	15	9	7	13	13	10	7	11	11	9	6	10	9	8	5	8	7	5	7	6	5	4	5	4	4	4		

注) カウンタウエイト0t、アウトリガ張出幅 7.0m 印はアタッチメント付きの値です。 印は後方限定の値です。

定格総荷重表

M性能

7段ESPブーム

(単位: t)

性能ブロック	1	1	10	1	10	2	1	10	11	2	1	11	12	2	1	12	13	2	1	13	2	1	14	2	3	1	5	4	1	6	4	1	7	8	1	8	1	1	9	
性能番号	1	1	29	2	30	14	3	31	32	15	4	33	34	16	5	35	36	17	6	37	18	7	38	19	20	8	23	21	9	24	22	10	25	26	11	27	12	13	28	
ブーム長さ(m)		13.2	17.4	17.4	21.6	21.6	21.6	25.8	25.8	25.8	30.0	30.0	30.0	30.0	34.1	34.1	34.1	34.1	38.3	38.3	38.3	42.5	42.5	42.5	42.5	46.7	46.7	46.7	50.9	50.9	50.9	55.0	55.0	55.0	59.2	59.2	63.4	68.0		
作業半径(m)																																								
2.5	220.0																																							
3.0	180.0	146.9	108.0	60.3	108.0	63.9	45.8	94.0	94.0	65.0	47.2																													
3.5	169.5	130.5	108.0	56.9	108.0	61.0	43.0	94.0	94.0	62.4	44.6	80.0	77.5	63.0	40.4																									
4.0	158.1	117.0	108.0	53.9	108.0	58.3	40.5	94.0	94.0	60.0	42.4	80.0	77.5	60.8	38.6																									
4.5	137.9	105.6	105.7	51.2	105.1	56.0	38.3	94.0	94.0	57.7	40.3	80.0	77.5	58.8	36.9	70.0	58.0	51.0	35.0																					
5.0	122.0	95.9	96.0	48.8	95.3	53.7	36.1	94.0	94.0	55.7	38.4	80.0	77.5	56.9	35.3	70.0	58.0	51.0	33.7	54.5	43.5	30.0																		
6.0	85.9	80.5	80.5	44.6	79.9	49.9	32.4	79.0	80.5	52.1	35.2	79.2	77.5	53.5	31.8	70.0	58.0	51.0	32.1	54.5	43.5	30.0	43.5	37.6	31.5	25.5														
7.0	63.3	63.3	63.3	41.1	62.3	46.6	29.3	61.1	63.2	48.9	32.0	62.2	64.4	50.5	28.5	63.4	58.0	49.3	30.0	54.5	43.5	28.5	43.5	37.6	31.5	25.5	34.5	25.3	21.4											
8.0	49.5	49.5	49.4	38.1	48.5	42.8	26.8	47.3	49.3	46.2	29.1	48.4	50.4	47.9	25.8	49.4	51.6	49.3	28.0	50.7	43.5	27.5	43.5	37.6	31.5	25.5	34.5	25.3	21.4	28.5	22.6	18.9								
9.0	40.2	40.2	39.9	35.6	39.1	39.4	24.6	38.0	39.8	43.8	26.6	39.0	40.9	44.6	23.5	40.0	42.0	44.1	26.2	41.1	43.2	26.0	41.1	37.6	31.5	25.1	34.5	25.3	21.4	28.5	22.6	18.9	23.0	19.2	16.9					
10.0	33.5	33.5	33.2	33.5	32.3	36.4	22.8	31.3	33.0	37.7	24.6	32.2	34.0	37.5	21.6	33.1	35.1	37.1	24.5	34.2	36.2	24.7	34.2	35.4	31.0	24.5	34.5	24.7	21.4	28.5	22.6	18.9	23.0	19.2	16.9	18.8	15.0			
11.0			28.0	30.9	27.2	32.0	21.2	26.3	27.9	32.4	22.8	27.1	28.8	32.1	19.9	28.0	29.8	31.7	22.7	29.0	30.9	23.2	29.0	30.1	29.7	23.5	30.0	23.6	21.4	28.5	22.6	18.9	23.0	19.2	16.9	18.8	15.0	15.0		
12.0			24.0	26.7	23.2	27.8	19.9	22.3	23.8	28.2	21.2	23.1	24.7	28.0	18.5	23.9	25.7	27.6	21.1	25.0	26.8	21.5	24.9	26.0	27.7	22.5	25.9	22.8	21.4	26.1	22.6	18.9	23.0	19.2	16.9	18.8	15.0	15.0	13.8	
14.0			18.2	20.7	17.4	21.7	17.6	16.5	18.0	22.0	18.7	17.3	18.8	21.8	16.2	18.0	19.7	21.5	18.5	19.0	20.7	18.7	18.9	20.0	21.5	20.2	19.9	21.5	20.4	20.1	21.3	18.9	20.4	19.2	16.9	18.8	15.0	15.0	13.8	
16.0					13.4	17.5	15.8	12.5	13.9	17.8	16.7	13.2	14.7	17.6	14.3	13.9	15.5	17.2	16.4	14.8	16.5	16.5	14.8	15.8	17.3	18.3	15.7	17.8	18.7	15.9	17.0	18.4	16.1	17.1	16.9	16.5	15.0	15.0	13.8	
18.0					10.5	14.5	14.4	9.5	10.9	14.7	15.0	10.2	11.6	14.5	12.8	10.9	12.5	14.1	14.7	11.8	13.4	14.7	11.7	12.7	14.1	15.8	12.6	14.6	15.5	12.8	13.9	15.2	13.0	14.0	14.8	13.4	14.4	13.8	13.4	
20.0							7.0	8.6	12.3	12.9	7.7	9.3	12.1	11.6	8.6	10.1	11.7	13.3	9.5	11.0	13.2	9.4	10.3	11.7	13.4	10.2	12.2	13.1	10.4	11.5	12.8	10.7	11.5	12.4	11.0	11.9	11.4	11.4	11.4	
22.0							5.0	6.6	10.5	11.1	5.7	7.4	10.2	10.5	6.5	8.3	9.8	11.5	7.6	9.1	11.4	7.5	8.5	9.8	11.4	8.4	10.3	11.1	8.5	9.6	10.9	8.8	9.6	10.5	9.1	10.0	9.5	9.5		
24.0												4.1	5.8	8.7	9.7	4.9	6.7	8.3	9.9	5.9	7.6	9.9	5.8	6.9	8.3	9.9	6.8	8.7	9.6	6.9	8.0	9.3	7.2	8.1	8.9	7.6	8.5	8.0	7.9	
26.0												2.8	4.5	7.5	8.5	3.5	5.3	7.0	8.7	4.5	6.3	8.6	4.4	5.5	7.0	8.6	5.3	7.4	8.3	5.5	6.8	8.0	5.8	6.8	7.6	6.2	7.2	6.7	6.6	
28.0															2.4	4.2	6.0	7.6	3.3	5.1	7.5	3.2	4.3	5.9	7.5	4.1	6.3	7.2	4.3	5.6	6.9	4.6	5.7	6.5	5.0	6.1	5.5	5.4		
30.0																3.2	5.0	6.7	2.3	4.1	6.6	2.2	3.3	4.9	6.6	3.1	5.4	6.3	3.3	4.6	6.0	3.6	4.6	5.6	4.0	5.1	4.5	4.4		
32.0																					3.3	5.8		2.4	4.0	5.8	2.3	4.5	5.5	2.4	3.7	5.2	2.7	3.7	4.7	3.1	4.2	3.6	3.5	
34.0																					2.6	5.2		1.7	3.3	5.1		3.7	4.8	1.7	2.9	4.4	1.9	3.0	3.9	2.3	3.4	2.8	2.7	
36.0																																								
38.0																																								
40.0																																								
42.0																																								
44.0																																								
46.0																																								
48.0																																								
50.0																																								
52.0																																								
54.0																																								
56.0																																								
58.0																																								
60.0																																								
62.0																																								
64.0																																								
ピン無最大荷重	40.4	40.4	42.7	47.6	39.3	46.2	30.1	34.7	38.3	44.5	46.0	35.2	37.8	42.9	30.2	35.5	36.6	39.4	35.0	34.8	35.9	30.0	35.1	33.9	31.5	25.5	34.5	25.3	21.4	28.5	22.6	18.9	23.0	19.2	16.9	18.8	15.0	15.0	13.8	
(°)	0-84	0-84	0-84	0-84	0-84	0-84	0-84	0-84	0-84	0-84	0-84	0-84	0-84	0-84	0-84	0-84	0-84	0-84	0-84	0-84	0-84	0-84	44-84	0-84	0-84	0-84	46-84	0-84	0-84	48-84	41-84	0-84	52-84	47-84	44-84	56-84	52-84	60-84	63-84	
伸 長 状 態 (伸長割合%)																																								
伸縮ブーム1	0	0	0	0	46	0	0	92	46	0	0	92	46	0	0	92	46	0	0	92	46	0	92	46	0	92	46	0	92	46	0	92	46	0	92	46	0	92	100	
伸縮ブーム2	0	0	46	0	46	0	0	46	46	0	0	46	46	0	0	46	46	0	0	46	46	0	46	46	0	46	46	0	46	46	0	46								

定格総荷重表

N性能

7段ESPブーム

(単位: t)

性能ブロック	1	1	10	1	10	2	1	10	11	2	1	11	12	2	1	12	13	2	1	13	2	1	14	2	3	1	5	4	1	6	4	1	7	8	1	8	1	1	9	
性能番号	1	1	29	2	30	14	3	31	32	15	4	33	34	16	5	35	36	17	6	37	18	7	38	19	20	8	23	21	9	24	22	10	25	26	11	27	12	13	28	
ブーム長さ(m)	13.2	17.4	17.4	21.6	21.6	21.6	25.8	25.8	25.8	25.8	30.0	30.0	30.0	30.0	34.1	34.1	34.1	34.1	38.3	38.3	38.3	42.5	42.5	42.5	42.5	46.7	46.7	46.7	50.9	50.9	50.9	55.0	55.0	55.0	59.2	59.2	63.4	68.0		
作業半径(m)																																								
2.5	220.0																																							
3.0	180.0	140.6	108.0	60.3	108.0	63.9	45.8	94.0	94.0	65.0	47.2																													
3.5	169.5	124.5	108.0	56.9	108.0	61.0	43.0	94.0	94.0	62.4	44.6	80.0	77.5	63.0	40.4																									
4.0	147.7	111.2	108.0	53.9	108.0	58.3	40.5	94.0	94.0	60.0	42.4	80.0	77.5	60.8	38.6																									
4.5	128.7	100.0	100.1	51.2	99.5	56.0	38.3	94.0	94.0	57.7	40.3	80.0	77.5	58.8	36.9	70.0	58.0	51.0	35.0																					
5.0	102.7	90.6	90.7	48.8	90.0	53.7	36.1	89.1	90.6	55.7	38.4	80.0	77.5	56.9	35.3	70.0	58.0	51.0	33.7	54.5	43.5	30.0																		
6.0	67.8	67.8	67.8	44.6	66.7	49.9	32.4	65.3	67.7	52.1	35.2	66.6	69.2	53.5	31.8	67.9	58.0	51.0	32.1	54.5	43.5	30.0	43.5	37.6	31.5	25.5														
7.0	49.6	49.6	49.5	41.1	48.5	46.6	29.3	47.3	49.4	48.9	32.0	48.4	50.6	50.5	28.5	49.6	52.0	51.0	30.0	51.0	43.5	28.5	43.5	37.6	31.5	25.5	34.5	25.3	21.4											
8.0	38.4	38.4	38.2	38.1	37.3	42.8	26.8	36.2	38.1	43.5	29.1	37.2	39.2	43.2	25.8	38.3	40.5	42.8	28.0	39.6	41.8	27.5	39.5	37.6	31.5	25.5	34.5	25.3	21.4	28.5	22.6	18.9								
9.0	30.8	30.8	30.6	33.8	29.8	35.1	24.6	28.7	30.5	35.5	26.6	29.7	31.5	35.2	23.5	30.6	32.7	34.8	26.2	31.8	33.9	26.0	31.7	33.0	31.5	25.1	32.9	25.3	21.4	28.5	22.6	18.9	23.0	19.2	16.9					
10.0	25.5	25.5	25.1	28.1	24.3	29.3	22.8	23.3	25.0	29.7	24.6	24.2	25.9	29.5	21.6	25.1	27.0	29.0	24.5	26.2	28.2	24.7	26.2	27.4	29.2	24.5	27.3	24.7	21.4	27.5	22.6	18.9	23.0	19.2	16.9	18.8	15.0			
11.0			21.0	23.8	20.2	25.0	21.2	19.2	20.8	25.3	22.8	20.1	21.7	25.1	19.9	20.9	22.8	24.7	22.7	22.0	23.9	23.2	21.9	23.1	24.8	23.5	23.0	23.6	21.4	23.2	22.6	18.9	23.0	19.2	16.9	18.8	15.0	15.0		
12.0			17.7	20.4	16.9	21.6	19.9	16.0	17.6	21.9	21.2	16.8	18.4	21.7	18.5	17.7	19.4	21.3	21.1	18.7	20.5	21.5	18.6	19.7	21.4	22.5	19.6	21.9	21.4	19.9	21.1	18.9	20.1	19.2	16.9	18.8	15.0	15.0	13.8	
14.0			13.1	15.6	12.2	16.6	16.8	11.4	12.8	16.9	17.6	12.1	13.6	16.7	16.2	12.9	14.6	16.3	18.2	13.8	15.5	18.2	13.8	14.8	16.4	18.2	14.7	16.9	17.9	14.9	16.1	17.6	15.2	16.2	16.9	15.6	15.0	15.0	13.8	
16.0					9.0	13.1	13.3	8.0	9.5	13.4	14.1	8.8	10.3	13.2	14.3	9.6	11.2	12.8	14.7	10.5	12.1	14.6	10.4	11.4	12.9	14.6	11.3	13.4	14.3	11.5	12.6	14.0	11.8	12.7	13.6	12.1	13.1	12.6	12.5	
18.0					6.3	10.6	10.8	5.3	6.9	10.9	11.5	6.1	7.8	10.7	11.8	7.0	8.7	10.3	12.0	8.0	9.6	12.0	7.9	8.9	10.3	12.0	8.8	10.8	11.7	9.0	10.1	11.4	9.2	10.1	11.0	9.6	10.5	10.0	10.0	
20.0							3.2	4.9	8.9	9.6	4.0	5.7	8.7	9.8	4.8	6.8	8.3	10.1	5.9	7.6	10.0	5.8	7.0	8.4	10.0	6.8	8.8	9.7	7.0	8.1	9.4	7.3	8.2	9.0	7.6	8.6	8.0	8.0		
22.0							1.7	3.3	7.5	8.1	2.3	4.1	7.2	8.3	3.2	5.0	6.8	8.5	4.2	6.1	8.4	4.1	5.3	6.8	8.4	5.1	7.2	8.1	5.3	6.6	7.9	5.6	6.6	7.4	6.0	7.0	6.5	6.4		
24.0													2.7	6.0	7.0	1.8	3.7	5.5	7.2	2.8	4.7	7.1	2.7	3.9	5.6	7.1	3.7	6.0	6.8	3.9	5.2	6.6	4.2	5.3	6.2	4.6	5.7	5.1	5.1	
26.0													1.7	5.0	6.0		2.5	4.4	6.2	1.7	3.5	6.1		2.7	4.4	6.1	2.6	4.9	5.8		4.1	5.5		4.1	5.1	3.4	4.6	3.9		
28.0																			3.4	5.3		2.6	5.2		3.4	5.2		3.9	4.9		3.1	4.6		3.1	4.1		3.6			
30.0																			2.7	4.6		1.8	4.5		2.5	4.4		3.0	4.1		2.2	3.7		3.2	2.7		2.7			
32.0																																								
34.0																																								
36.0																																								
38.0																																								
40.0																																								
42.0																																								
44.0																																								
46.0																																								
48.0																																								
50.0																																								
ピン無最大荷重	40.4	40.4	42.7	47.6	39.3	46.2	30.1	34.7	38.3	44.5	46.0	35.2	37.8	42.9	30.2	35.5	36.6	39.4	35.0	34.8	35.9	30.0	35.1	33.9	31.5	25.5	34.5	25.3	21.4	28.5	22.6	18.9	23.0	19.2	16.9	18.8	15.0	15.0	13.8	
(°)	0~84	0~84	0~84	0~84	0~84	0~84	0~84	0~84	0~84	0~84	38~84	0~84	0~84	0~84	0~84	42~84	0~84	0~84	0~84	45~84	0~84	0~84	55~84	52~84	39~84	0~84	56~84	42~84	0~84	63~84	54~84	45~84	65~84	61~84	53~84	66~84	61~84	68~84	73~84	
伸 長 状 態 (伸長割合%)																																								
伸縮ブーム1	0	0	0	0	46	0	0	92	46	0	0	92	46	0	0	92	46	0	0	92	46	0	92	46	0	92	46	0	92	46	0	92	46	0	92	46	0	92	46	92
伸縮ブーム2	0	0	46	0	46	0	0	46	46	0	0	46	46	0	0	46	46	0	0	46	46	0	46	46	0	46	46	0	46	46	0	46	46	0	46	46	0	46	46	100
伸縮ブーム3	0	0	0	0	0	0	0	0	46	0	0	46	46	46	0	46	46	46	0	46	46	0	46	46	46	46	46	46	92	92	46	92	92	46	92	92	92	92	100	
伸縮ブーム4	0	0	0	0	0	0	0	0	46	0	0	46	46	46	0	46	46	46	46	46	46	92	46	46	46	92	46	46	92	46	46	92	46	92	92	92	92	92	100	
伸縮ブーム5	0	0	0	0	0	46	0	0	46	46	0	0	46	92	0	46	46	92	46	46	92	46	46	46	92	46	92	92	46	92	46	92	46	92	92	92	92	92	100	
伸縮ブーム6	0	0	0	46	0	46	92	0	0	46	92	0	0	46	92	0	0	46	92	0	46	92	0	46	92	92	46	92	92	46	92	46	92	46	92	46	92	46	92	
標準フック	125t x 2	125t	80t	125t	80t	80t	125t	125t	80t	80t	80t	80t	80t	80t	80t	80t	80t	80t	80t	80t	80t	80t	80t	80t	80t	80t	80t	80t	80t	80t	80t	80t	80t	80t	80t	80t	80t	80t		
フック質量	1425kg x 2	1350kg	1150kg	1350kg	1150kg	1150kg	1350																																	

定格総荷重表

○性能

7段ESPブーム

(単位: t)

性能ブロック	1	1	10	1	10	2	1	10	11	2	1	11	12	2	1	12	13	2	1	13	2	1	14	2	3	1	5	4	1	6	4	1	7	8	1	8	1	1	9		
性能番号	1	1	29	2	30	14	3	31	32	15	4	33	34	16	5	35	36	17	6	37	18	7	38	19	20	8	23	21	9	24	22	10	25	26	11	27	12	13	28		
ブーム長さ(m)		13.2	17.4	17.4	21.6	21.6	21.6	25.8	25.8	25.8	30.0	30.0	30.0	30.0	34.1	34.1	34.1	34.1	38.3	38.3	38.3	42.5	42.5	42.5	42.5	46.7	46.7	46.7	50.9	50.9	50.9	55.0	55.0	55.0	59.2	59.2	63.4	68.0			
作業半径(m)																																									
2.5	220.0																																								
3.0	180.0	133.8	108.0	60.3	108.0	63.9	45.8	94.0	94.0	65.0	47.2																														
3.5	160.6	118.0	108.0	56.9	108.0	61.0	43.0	94.0	94.0	62.4	44.6	80.0	77.5	63.0	40.4																										
4.0	137.2	104.9	105.0	53.9	104.3	58.3	40.5	94.0	94.0	60.0	42.4	80.0	77.5	60.8	38.6																										
4.5	101.4	94.0	94.1	51.2	93.4	56.0	38.3	92.5	94.0	57.7	40.3	80.0	77.5	58.8	36.9	70.0	58.0	51.0	35.0																						
5.0	76.3	76.3	76.5	48.8	75.1	53.7	36.1	73.3	76.4	55.7	38.4	75.0	77.5	56.9	35.3	70.0	58.0	51.0	33.7	54.5	43.5	30.0																			
6.0	49.7	49.7	49.7	44.6	48.6	49.9	32.4	47.2	49.6	52.1	35.2	48.5	51.0	53.5	31.8	49.8	52.7	51.0	32.1	51.5	43.5	30.0	43.5	37.6	31.5	25.5															
7.0	35.7	35.7	35.7	39.5	34.7	41.1	29.3	33.5	35.6	41.5	32.0	34.6	36.8	41.3	28.5	35.8	38.2	40.7	30.0	37.2	39.7	28.5	37.1	37.6	31.5	25.5	34.5	25.3	21.4												
8.0	27.2	27.2	27.1	30.5	26.2	31.9	26.8	25.1	27.0	32.3	29.1	26.1	28.1	32.1	25.8	27.1	29.3	31.6	28.0	28.4	30.6	27.5	28.3	29.7	31.5	25.5	29.6	25.3	21.4	23.8	22.6	18.9									
9.0	21.5	21.5	21.2	24.4	20.4	25.7	24.6	19.4	21.1	26.1	26.6	20.3	22.2	25.9	23.5	21.3	23.3	25.4	26.2	22.4	24.5	26.0	22.4	23.7	25.6	25.1	23.6	25.3	21.4	23.8	22.6	18.9	23.0	19.2	16.9						
10.0	17.4	17.4	17.0	20.0	16.2	21.2	21.6	15.3	16.9	21.6	22.5	16.1	17.9	21.4	21.6	17.0	19.0	21.0	23.2	18.1	20.1	23.2	18.1	19.3	21.1	23.2	19.2	21.7	21.4	19.4	20.8	18.9	19.7	19.2	16.9	18.8	15.0				
11.0			13.9	16.7	13.1	17.9	18.2	12.1	13.7	18.2	19.0	13.0	14.7	18.0	19.5	13.8	15.7	17.6	19.7	14.9	16.8	19.7	14.8	16.0	17.7	19.7	15.9	18.3	19.4	16.1	17.4	18.9	16.4	17.5	16.9	16.8	15.0	15.0			
12.0			11.4	14.1	10.6	15.2	15.5	9.7	11.2	15.6	16.3	10.5	12.1	15.4	16.7	11.4	13.1	15.0	17.0	12.4	14.2	17.0	12.3	13.4	15.1	17.0	13.3	15.6	16.7	13.5	14.8	16.3	13.8	14.9	15.8	14.2	15.0	14.7	13.8		
14.0			7.9	10.4	6.9	11.4	11.6	5.8	7.6	11.7	12.4	6.8	8.4	11.5	12.8	7.7	9.4	11.1	13.0	8.6	10.3	13.0	8.6	9.6	11.2	13.0	9.5	11.7	12.7	9.7	10.9	12.4	10.0	11.0	11.9	10.4	11.4	10.8	10.8		
16.0					4.1	8.7	8.9	3.0	4.8	9.0	9.7	3.9	5.7	8.8	10.0	4.8	6.8	8.4	10.3	6.0	7.7	10.2	5.9	7.0	8.5	10.2	6.9	9.0	9.9	7.1	8.2	9.6	7.4	8.3	9.2	7.7	8.7	8.2	8.1		
18.0					2.1	6.8	7.0		2.7	7.0	7.7		3.6	6.8	8.0		4.7	6.4	8.2	3.8	5.7	8.2		4.9	6.5	8.2	4.8	7.0	7.9		6.3	7.6		6.3	7.2		6.7	6.2			
20.0										5.6	6.2		2.0	5.3	6.5		3.0	4.9	6.7		4.1	6.6			5.0	6.6		5.4	6.3		4.7	6.1		4.7	5.6		5.2				
22.0										4.4	5.0			4.1	5.3			3.6	5.4		2.7	5.4			3.6	5.4		4.1	5.1			4.8			4.3						
24.0														3.0	4.3			2.5	4.5			4.4			2.5	4.4		3.0	4.1			3.7			3.2						
26.0														2.2	3.4				3.6			3.5				3.5			3.1			2.8									
28.0																			2.9			2.7				2.7			2.3												
30.0																			2.2			2.1				2.0															
32.0																																									
34.0																																									
36.0																																									
38.0																																									
40.0																																									
42.0																																									
44.0																																									
46.0																																									
48.0																																									
50.0																																									
ピン無最大荷重 (t)	40.4	40.4	42.7	47.6	39.3	46.2	30.1	34.7	38.3	44.5	46.0	35.2	37.8	42.9	30.2	35.5	36.6	39.4	35.0	34.8	35.9	30.0	35.1	33.9	31.5	25.5	34.5	25.3	21.4	28.5	22.6	18.9	23.0	19.2	16.9	18.8	15.0	15.0	13.8		
(°)	0-84	0-84	0-84	0-84	0-84	0-84	0-84	48-84	41-84	0-84	0-84	55-84	45-84	0-84	0-84	60-84	52-84	42-84	0-84	61-84	54-84	0-84	68-84	65-84	54-84	44-84	68-84	58-84	53-84	73-84	67-84	60-84	74-84	70-84	66-84	76-84	72-84	76-84	80-84		
伸長状態 (伸長割合%)																																									
伸縮ブーム1	0	0	0	0	46	0	0	92	46	0	0	92	46	0	0	92	46	0	0	92	46	0	92	92	46	0	92	46	0	92	92	0	92	46	0	92	46	92	100		
伸縮ブーム2	0	0	46	0	46	0	0	46	46	0	0	46	46	0	0	46	46	46	0	46	46	0	92	46	46	0	92	46	0	92	46	46	92	92	92	92	92	92	92	100	
伸縮ブーム3	0	0	0	0	0	0	0	0	46	0	0	46	46	46	0	46	46	46	0	46	46	0	46	46	46	46	46	46	92	92	46	92	92	92	92	92	92	92	92	100	
伸縮ブーム4	0	0	0	0	0	0	0	0	0	46	0	0	46	46	0	46	46	46	46	46	46	46	46	46	46	92	46	46	46	92	46	46	92	92	92	92	92	92	92	92	100
伸縮ブーム5	0	0	0	0	0	46	0	0	0	46	46	0	0	46	92	0	46	46	92	46	46	92	46	46	92	46	92	46	92	46	92	46	92	92	92	92	92	92	92	100	
伸縮ブーム6	0	0	0	46	0	46	92	0	0	46	92	0	0	46	92	0	46	92	0	46	92	0	46	92	46	92	46	92	46	92	46	92	46	92	46	92	46	92	92	100	
標準フック	125t×2	125t	80t	125t	80t	80t	125t	125t	80t	80t	80t	80t	80t	80t	80t	80t	80t	80t	80t	80t	80t	80t	80t	80t	80t	80t	80t	80t	80t	80t	80t	80t	80t	80t	80t	80t	80t	80t	80t	80t	
フック質量	1425kg×2	1350kg	1150kg	1350kg	1150kg	1150kg	1350kg	1350kg	1150kg	1150kg	1150kg	1150kg	1150kg	1150kg	1150kg	1150kg	1150kg	1150kg	1150kg	1150kg	1150kg	1150kg	1150kg	1150kg	1150kg	1150kg	1150kg	1150kg	1150kg	1150kg	1150kg	1150kg	1150kg	1150kg	1150kg	1150kg	1150kg	1150kg	1150kg		
標準巻掛本数	19×2	15	9	15</																																					

定格総荷重表

P性能 7段ESPブーム

(単位: t)

性能ブロック	1	1	2	1	2	1	2	1	2	1
性能番号	1	2	14	3	15	4	16	5	17	6
ブーム長さ(m)	13.2	17.4	21.6	21.6	25.8	25.8	30.0	30.0	34.1	34.1
作業半径(m)										
2.5										
3.0	127.8	60.3	63.9	45.8	65.0	47.2				
3.5	112.1	56.9	61.0	43.0	62.4	44.6	63.0	40.4		
4.0	99.3	53.9	58.3	40.5	60.0	42.4	60.8	38.6		
4.5	73.8	51.2	56.0	38.3	57.7	40.3	58.8	36.9	51.0	35.0
5.0	54.9	48.8	53.7	36.1	55.7	38.4	56.9	35.3	51.0	33.7
6.0	34.9	39.3	41.1	32.4	41.7	35.2	41.4	31.8	40.8	32.1
7.0	24.5	28.2	29.8	29.3	30.2	31.3	30.0	28.5	29.5	30.0
8.0	18.1	21.4	22.8	23.1	23.2	24.2	23.0	24.7	22.5	25.0
9.0	13.8	16.8	18.1	18.4	18.5	19.4	18.2	19.8	17.8	20.1
10.0	10.8	13.4	14.7	14.9	15.0	15.9	14.8	16.3	14.4	16.6
11.0		10.9	12.1	12.4	12.4	13.2	12.2	13.7	11.8	13.9
12.0		8.9	10.1	10.3	10.4	11.2	10.2	11.6	9.8	11.8
14.0		6.1	7.1	7.4	7.4	8.2	7.3	8.5	6.9	8.8
16.0			5.1	5.3	5.4	6.1	5.2	6.4	4.8	6.7
18.0			3.6	3.7	3.9	4.6	3.7	4.9	3.2	5.1
20.0					2.6	3.4	2.3	3.7		3.9
22.0						2.4		2.7		2.9
24.0								1.8		2.0
26.0										
28.0										
30.0										
32.0										
34.0										
36.0										
38.0										
40.0										
ピン無最大荷重	40.4	47.6	46.2	30.1	44.5	46.0	42.9	30.2	39.4	35.0
(°)	0~84	0~84	0~84	0~84	0~84	0~84	44~84	0~84	56~84	42~84
伸 長 状 態 (伸長割合%)										
伸縮ブーム1	0	0	0	0	0	0	0	0	0	0
伸縮ブーム2	0	0	0	0	0	0	0	0	46	0
伸縮ブーム3	0	0	0	0	0	0	46	0	46	0
伸縮ブーム4	0	0	0	0	46	0	46	0	46	46
伸縮ブーム5	0	0	46	0	46	46	46	92	46	92
伸縮ブーム6	0	46	46	92	46	92	46	92	46	92
標準フック	125t×2	80t	80t	80t	80t	80t	80t	80t	80t	80t
フック質量	1425kg×2	1150kg	1150kg	1150kg	1150kg	1150kg	1150kg	1150kg	1150kg	1150kg
標準巻掛本数	19×2	9	9	7	10	7	9	6	8	5

注) カウンタウエイト0t、アウトリガ張出幅 5.6m 印はアタッチメント付きの値です。

定格総荷重表

Q性能

7段ESPブーム

(単位: t)

性能ブロック	1	1	10	1	10	2	1	10	11	2	1	11	12	2	1	12	13	2	1	13	2	1	14	2	3	1	5	4	1	6	4	1	7	8	1	8	1	1	1	9		
性能番号	1	1	29	2	30	14	3	31	32	15	4	33	34	16	5	35	36	17	6	37	18	7	38	19	20	8	23	21	9	24	22	10	25	26	11	27	12	13	28			
ブーム長さ(m)		13.2	17.4	17.4	21.6	21.6	21.6	25.8	25.8	25.8	30.0	30.0	30.0	30.0	34.1	34.1	34.1	34.1	38.3	38.3	38.3	42.5	42.5	42.5	42.5	46.7	46.7	46.7	50.9	50.9	50.9	55.0	55.0	55.0	59.2	59.2	63.4	68.0				
作業半径(m)																																										
2.5	220.0																																									
3.0	180.0	123.2	108.0	60.3	108.0	63.9	45.8	94.0	94.0	65.0	47.2																															
3.5	128.9	107.9	108.0	56.9	107.4	61.0	43.0	94.0	94.0	62.4	44.6	80.0	77.5	63.0	40.4																											
4.0	88.3	88.3	88.6	53.9	87.1	58.3	40.5	85.1	88.5	60.0	42.4	80.0	77.5	60.8	38.6																											
4.5	66.2	66.2	66.3	51.2	65.1	56.0	38.3	63.4	66.3	57.7	40.3	65.0	67.9	58.8	36.9	66.5	58.0	51.0	35.0																							
5.0	52.2	52.2	52.4	48.8	51.2	53.7	36.1	49.8	52.3	55.7	38.4	51.1	53.8	56.9	35.3	52.5	55.4	51.0	33.7	54.2	43.5	30.0																				
6.0	35.7	35.7	35.7	39.6	34.7	41.1	32.4	33.5	35.6	41.6	35.2	34.7	36.9	41.3	31.8	35.8	38.3	40.8	32.1	37.2	39.7	30.0	37.2	37.6	31.5	25.5																
7.0	26.2	26.2	26.2	29.6	25.3	31.0	29.3	24.2	26.1	31.4	32.0	25.2	27.2	31.1	28.5	26.2	28.4	30.7	30.0	27.5	29.7	28.5	27.4	28.8	30.9	25.5	28.7	25.3	21.4													
8.0	20.1	20.1	20.0	23.1	19.1	24.4	24.7	18.1	19.9	24.8	25.7	19.1	20.9	24.6	25.8	20.0	22.0	24.1	26.5	21.2	23.2	26.4	21.1	22.4	24.3	25.5	22.3	24.9	21.4	22.6	22.6	18.9										
9.0	15.9	15.9	15.6	18.6	14.9	19.8	20.1	13.9	15.5	20.1	21.0	14.8	16.5	19.9	21.4	15.7	17.6	19.5	21.7	16.8	18.7	21.7	16.7	17.9	19.7	21.7	17.8	20.2	21.4	18.0	19.4	18.9	18.3	19.2	16.9							
10.0	12.8	12.8	12.4	15.2	11.7	16.4	16.7	10.8	12.3	16.7	17.5	11.6	13.2	16.5	17.9	12.4	14.2	16.1	18.2	13.5	15.3	18.2	13.4	14.6	16.2	18.2	14.5	16.8	17.9	14.7	16.0	17.5	15.0	16.0	16.9	15.4	15.0					
11.0			10.0	12.7	9.2	13.8	14.0	8.4	9.9	14.1	14.9	9.2	10.7	13.9	15.2	10.0	11.7	13.5	15.5	11.0	12.7	15.5	10.9	12.0	13.6	15.5	11.9	14.1	15.2	12.1	13.3	14.8	12.4	13.4	14.4	12.8	13.9	13.2				
12.0			8.1	10.6	7.2	11.7	11.9	6.2	7.9	12.0	12.7	7.1	8.7	11.8	13.1	8.0	9.7	11.4	13.4	9.0	10.7	13.3	8.9	10.0	11.5	13.3	9.9	12.0	13.0	10.1	11.3	12.7	10.3	11.3	12.3	10.7	11.8	11.2	11.1			
14.0			4.9	7.6	4.0	8.6	8.8		4.7	8.9	9.6		5.6	8.7	9.9	4.7	6.7	8.3	10.2	5.9	7.6	10.1		6.9	8.4	10.1	6.8	8.9	9.8	7.0	8.2	9.6	7.3	8.2	9.1	7.7	8.7	8.1				
16.0					1.7	6.4	6.6			6.7	7.4		3.3	6.5	7.7		4.3	6.1	7.9		5.4	7.9			6.2	7.9		6.7	7.6		6.0	7.3		6.0	6.9		6.4					
18.0						4.9	5.0				5.1	5.7			4.9	6.0			4.5	6.2		3.6	6.2			4.5	6.2		5.0	5.9			5.6			5.2						
20.0											3.8	4.5			3.5	4.8			3.0	5.0			4.9			3.1	4.9		3.6	4.6			4.3									
22.0											2.7	3.4			2.4	3.7			1.9	3.9			3.9				3.9		3.5			3.2										
24.0																2.8			3.0			2.9				2.9		2.6														
26.0																2.0			2.2			2.2				2.1																
28.0																																										
30.0																																										
32.0																																										
34.0																																										
36.0																																										
38.0																																										
40.0																																										
ピン無最大荷重	40.4	40.4	42.7	47.6	39.3	46.2	30.1	34.7	38.3	44.5	46.0	35.2	37.8	42.9	30.2	35.5	36.6	39.4	35.0	34.8	35.9	30.0	35.1	33.9	31.5	25.5	28.7	25.3	21.4	22.6	22.6	18.9	18.3	19.2	16.9	15.4	15.0	13.2	11.1			
(°)	0~84	0~84	0~84	0~84	35~84	0~84	0~84	59~84	54~84	0~84	0~84	65~84	55~84	0~84	0~84	64~84	61~84	47~84	0~84	68~84	61~84	45~84	74~84	70~84	61~84	51~84	73~84	64~84	59~84	75~84	72~84	65~84	76~84	75~84	73~84	78~84	76~84	80~84	83~84			
伸 長 状 態 (伸長割合%)																																										
伸縮ブーム1	0	0	0	0	46	0	0	92	46	0	0	92	46	0	0	92	46	0	0	92	46	0	92	92	46	0	92	46	0	92	92	0	92	46	0	92	46	0	92	46	92	100
伸縮ブーム2	0	0	46	0	46	0	0	46	46	0	0	46	46	0	0	46	46	46	0	46	46	0	92	46	46	0	92	46	0	92	46	46	92	92	92	92	92	92	92	92	92	100
伸縮ブーム3	0	0	0	0	0	0	0	0	46	0	0	46	46	46	0	46	46	46	0	46	46	0	46	46	46	46	46	46	92	92	46	46	92	92	92	92	92	92	92	92	92	100
伸縮ブーム4	0	0	0	0	0	0	0	0	46	0	0	46	46	46	0	46	46	46	46	46	46	46	46	46	92	46	46	46	92	46	46	92	92	92	92	92	92	92	92	92	92	100
伸縮ブーム5	0	0	0	0	0	46	0	0	0	46	46	0	0	46	92	0	46	46	92	46	46	92	46	46	46	92	46	92	92	46	92	92	46	92	92	46	92	92	92	92	100	
伸縮ブーム6	0	0	0	46	0	46	92	0	0	46	92	0	0	46	92	0	0	46	92	0	46	92	0	46	92	92	46	92	92	46	92	92	46	92	92	46	92	92	92	92	100	
標準フック	125t×2	125t	80t	125t	80t	80t	125t	125t	80t	80t	80t	80t	80t	80t	80t	80t	80t	80t	80t	80t	80t	80t	80t	80t	80t	80t	80t	80t	80t	80t	80t	80t	80t	80t	80t	80t	80t	80t	80t	80t		
フック質量	1425kg×2	1350kg	1150kg	1350kg	1150kg	1150kg	1350kg	1350kg	1150kg	1150kg	1150kg	1150kg	1150kg	1150kg	1150kg	1150kg	1150kg	1150kg	1150kg	1150kg	1150kg	1150kg	1150kg	1150kg	1150kg	1150kg	1150kg	1150kg	1150kg	1150kg	1150kg	1150kg	1150kg	1150kg	1150kg	1150kg	1150kg	1150kg	1150kg			
標準巻掛本数	19×2	15	9	15	9	7	13	13	10	7	11	11	9	6	10	9	8	5	8	7	5	7	6	5	4	5	4	4	4	4	4	4	4	4	4	4	4	4	4			

注)カウンタウエイト12t、アウトリガ張幅 4.6m 印はアタッチメント付きの値です。 印は後方限定の値です。

定格総荷重表

R 性能

7段ESPブーム

(単位: t)

性能ブロック	1	1	2	1	2	1	2	1	2	1
性能番号	1	2	14	3	15	4	16	5	17	6
ブーム長さ(m)	13.2	17.4	21.6	21.6	25.8	25.8	30.0	30.0	34.1	34.1
作業半径(m)										
2.5										
3.0	116.4	60.3	63.9	45.8	65.0	47.2				
3.5	92.7	56.9	61.0	43.0	62.4	44.6	63.0	40.4		
4.0	62.8	53.9	58.3	40.5	60.0	42.4	60.8	38.6		
4.5	46.4	51.2	53.7	38.3	54.4	40.3	54.0	36.9	51.0	35.0
5.0	36.1	40.7	42.5	36.1	43.1	38.4	42.8	35.3	42.2	33.7
6.0	23.9	27.7	29.3	29.7	29.7	30.8	29.5	31.4	29.0	31.8
7.0	16.9	20.2	21.6	22.0	22.1	23.0	21.8	23.6	21.4	23.9
8.0	12.4	15.4	16.7	17.0	17.1	18.0	16.9	18.5	16.4	18.8
9.0	9.3	12.0	13.2	13.5	13.6	14.4	13.4	14.9	13.0	15.2
10.0	7.1	9.5	10.7	10.9	11.0	11.8	10.8	12.2	10.4	12.5
11.0		7.6	8.7	9.0	9.0	9.8	8.8	10.2	8.5	10.4
12.0		6.1	7.1	7.4	7.5	8.2	7.3	8.6	6.9	8.8
14.0		3.7	4.8	5.1	5.1	5.8	5.0	6.2	4.6	6.4
16.0			3.1	3.3	3.4	4.2	3.2	4.5		4.7
18.0			1.7	1.9	2.1	2.9		3.2		3.5
20.0						1.8		2.1		2.4
22.0										
24.0										
26.0										
28.0										
30.0										
32.0										
34.0										
36.0										
38.0										
40.0										
ピン無最大荷重	40.4	47.6	46.2	30.1	44.5	46.0	42.9	30.2	39.4	35.0
(°)	0~84	0~84	0~84	0~84	40~84	0~84	55~84	45~84	64~84	52~84
伸 長 状 態 (伸長割合%)										
伸縮ブーム1	0	0	0	0	0	0	0	0	0	0
伸縮ブーム2	0	0	0	0	0	0	0	0	46	0
伸縮ブーム3	0	0	0	0	0	0	46	0	46	0
伸縮ブーム4	0	0	0	0	46	0	46	0	46	46
伸縮ブーム5	0	0	46	0	46	46	46	92	46	92
伸縮ブーム6	0	46	46	92	46	92	46	92	46	92
標準フック	125t×2	80t	80t	80t	80t	80t	80t	80t	80t	80t
フック質量	1425kg×2	1150kg	1150kg	1150kg	1150kg	1150kg	1150kg	1150kg	1150kg	1150kg
標準巻掛本数	19×2	9	9	7	10	7	9	6	8	5

注) カウンタウエイト0t、アウトリガ張出幅 4.6m
印はアタッチメント付きの値です。

S 性能

7段ESPブーム

(単位: t)

性能ブロック	1	1	1	1	1	1
性能番号	1	2	3	4	5	6
ブーム長さ(m)	13.2	17.4	21.6	25.8	30.0	34.1
作業半径(m)						
2.5	80.0					
3.0	80.0	57.3	43.5	44.8		
3.5	80.0	54.1	40.9	42.4	38.4	
4.0	80.0	51.2	38.5	40.3	36.7	
4.5	80.0	48.6	36.4	38.3	35.1	33.3
5.0	80.0	46.4	34.3	36.5	33.5	32.0
6.0	74.3	42.4	30.8	33.4	30.2	30.5
7.0	50.7	39.0	27.8	30.4	27.1	28.5
8.0	37.6	36.2	25.5	27.6	24.5	26.6
9.0	29.2	32.5	23.4	25.3	22.3	24.9
10.0	22.9	25.9	21.7	23.4	20.5	23.3
11.0		21.1	20.1	21.7	18.9	21.6
12.0		17.6	18.9	20.0	17.6	20.0
14.0		12.6	14.1	14.9	15.3	15.6
16.0			10.6	11.5	11.9	12.1
18.0			8.3	9.1	9.4	9.6
20.0				7.3	7.6	7.8
22.0				6.0	6.2	6.4
24.0					5.1	5.2
26.0					4.2	4.4
28.0						3.6
30.0						2.9
32.0						
34.0						
36.0						
38.0						
40.0						
ピン無最大荷重	40.4	47.6	30.1	44.8	30.2	33.3
(°)	0~84	0~84	0~84	0~84	0~84	0~84
伸 長 状 態 (伸長割合%)						
伸縮ブーム1	0	0	0	0	0	0
伸縮ブーム2	0	0	0	0	0	0
伸縮ブーム3	0	0	0	0	0	0
伸縮ブーム4	0	0	0	0	0	46
伸縮ブーム5	0	0	0	46	92	92
伸縮ブーム6	0	46	92	92	92	92
標準フック	80t	80t	80t	80t	80t	80t
フック質量	1150kg	1150kg	1150kg	1150kg	1150kg	1150kg
標準巻掛本数	11	9	7	7	6	5

注) カウンタウエイト0t、アウトリガ張出幅 2.74m

T 性能

7段ESPブーム

(単位: t)

性能ブロック	1	1	1	1	1	1
性能番号	1	2	3	4	5	6
ブーム長さ(m)	13.2	17.4	21.6	25.8	30.0	34.1
作業半径(m)						
2.5	68.3					
3.0	44.5	49.8	45.8	47.2		
3.5	31.9	36.4	38.7	40.0	40.4	
4.0	24.1	28.1	30.1	31.3	31.9	
4.5	18.8	22.4	24.3	25.4	25.9	26.3
5.0	14.9	18.3	20.1	21.1	21.6	21.9
6.0	9.7	12.8	14.3	15.3	15.7	16.0
7.0	6.4	9.2	10.7	11.5	12.0	12.2
8.0		6.7	8.1	8.9	9.3	9.6
9.0		4.9	6.2	7.0	7.4	7.6
10.0		3.3	4.7	5.5	5.9	6.1
11.0		2.0	3.6	4.3	4.7	4.9
12.0			2.5	3.4	3.8	4.0
14.0						
16.0						
18.0						
20.0						
22.0						
24.0						
26.0						
28.0						
30.0						
32.0						
34.0						
36.0						
38.0						
40.0						
ピン無最大荷重	40.4	47.6	30.1	46.0	30.2	26.3
(°)	49~84	43~84	51~84	59~84	64~84	68~84
伸 長 状 態 (伸長割合%)						
伸縮ブーム1	0	0	0	0	0	0
伸縮ブーム2	0	0	0	0	0	0
伸縮ブーム3	0	0	0	0	0	0
伸縮ブーム4	0	0	0	0	0	46
伸縮ブーム5	0	0	0	46	92	92
伸縮ブーム6	0	46	92	92	92	92
標準フック	80t	80t	80t	80t	80t	80t
フック質量	1150kg	1150kg	1150kg	1150kg	1150kg	1150kg
標準巻掛本数	11	9	7	7	6	5

注) カウンタウエイト0t、アウトリガ張出幅 2.74m

3. 作業半径 - 揚程図

63.4mブーム

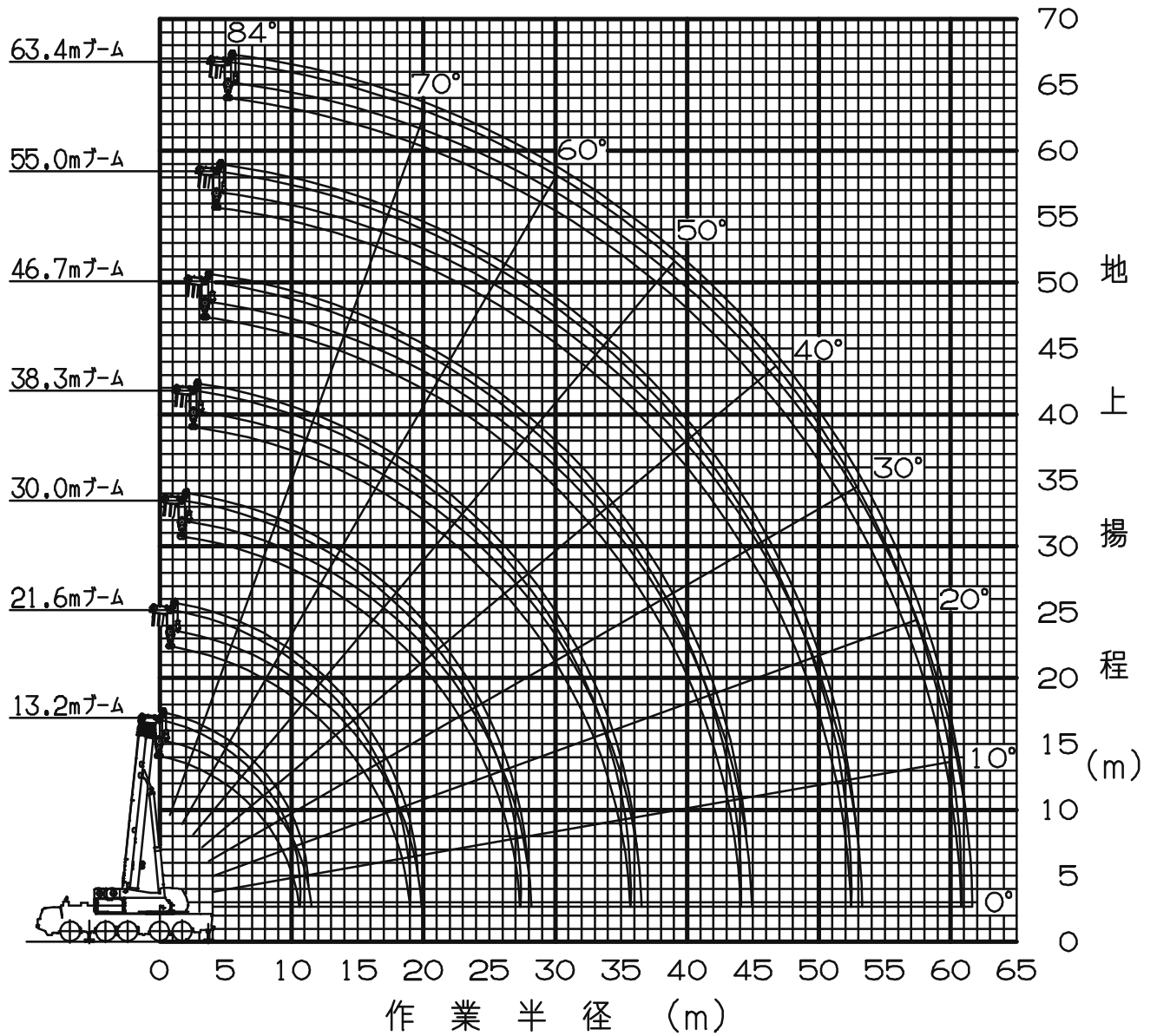

- (注) 1. 上図はブームのたわみを含んでいません。
 2. A, B, G性能の最大作業半径を図示しています。

68.0mブーム

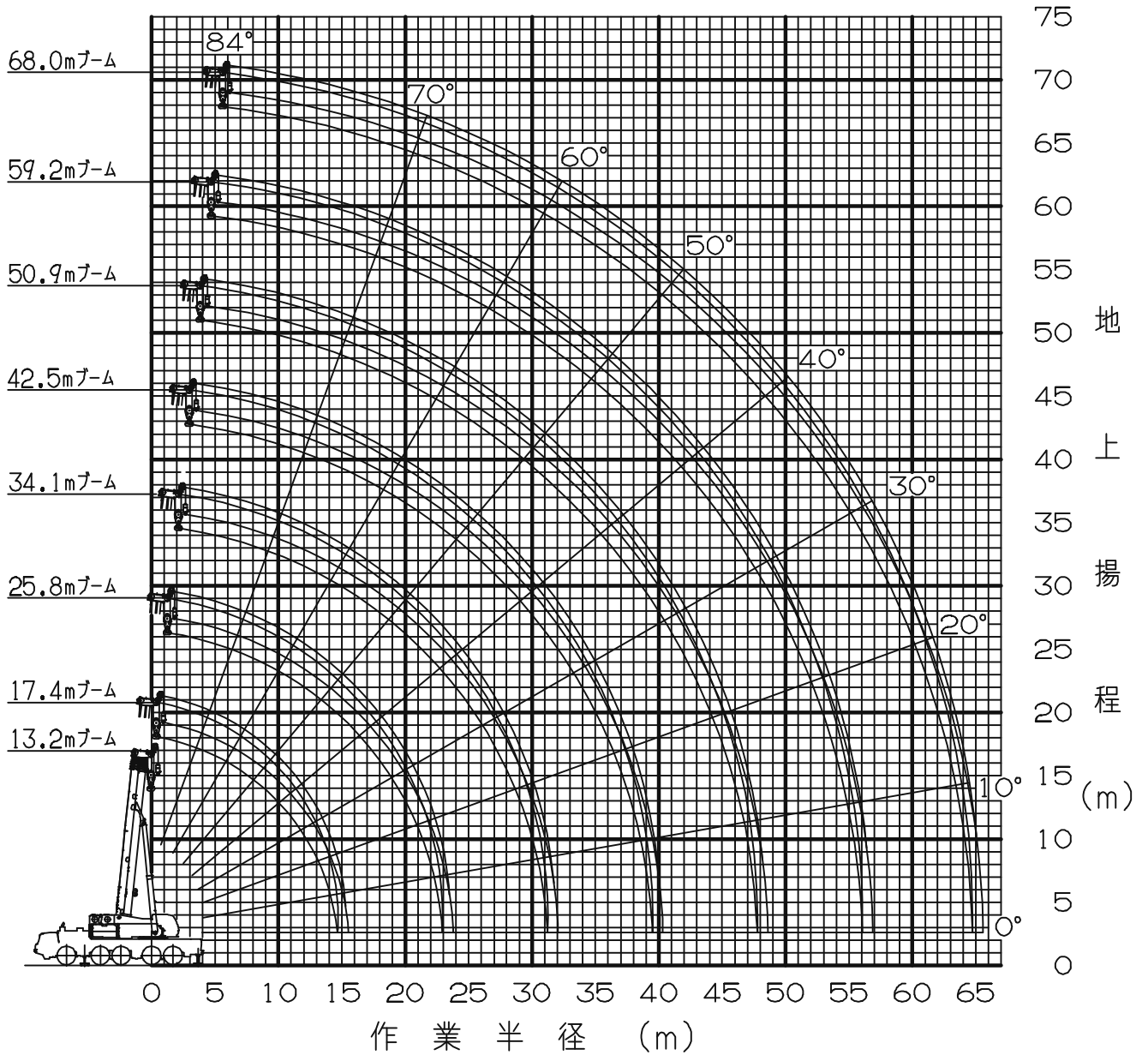

- (注) 1. 上図はブームのたわみを含んでいません。
 2. A, B, G性能の最大作業半径を図示しています。

4. 外 観 図 [公道 走行 状態]

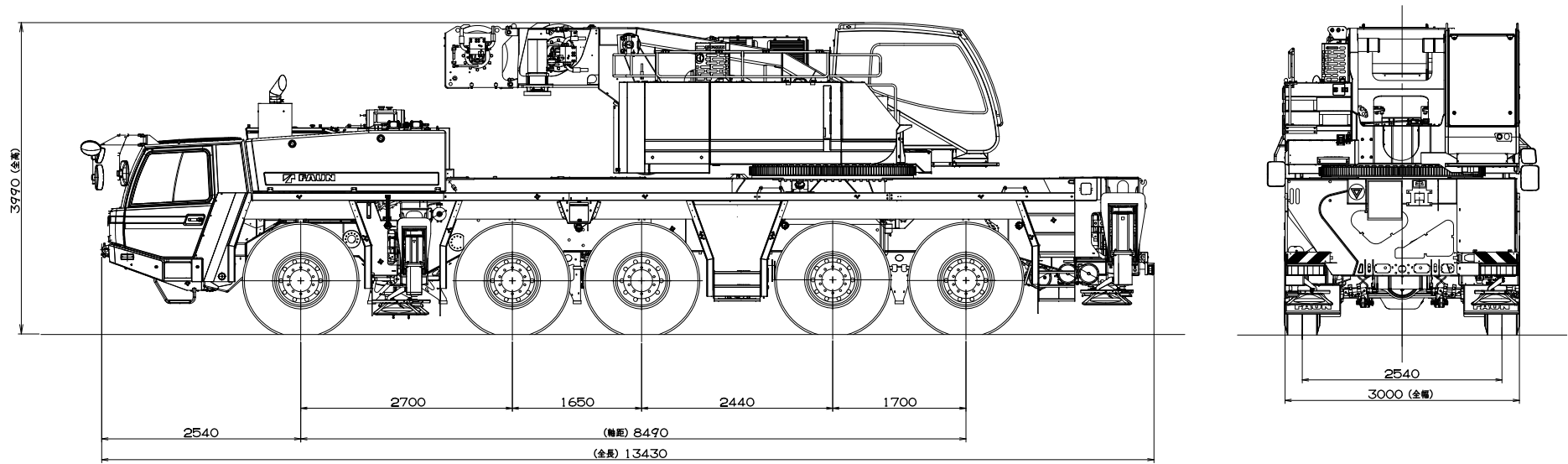

4. 外 観 図 [構 内 走 行 状 態]

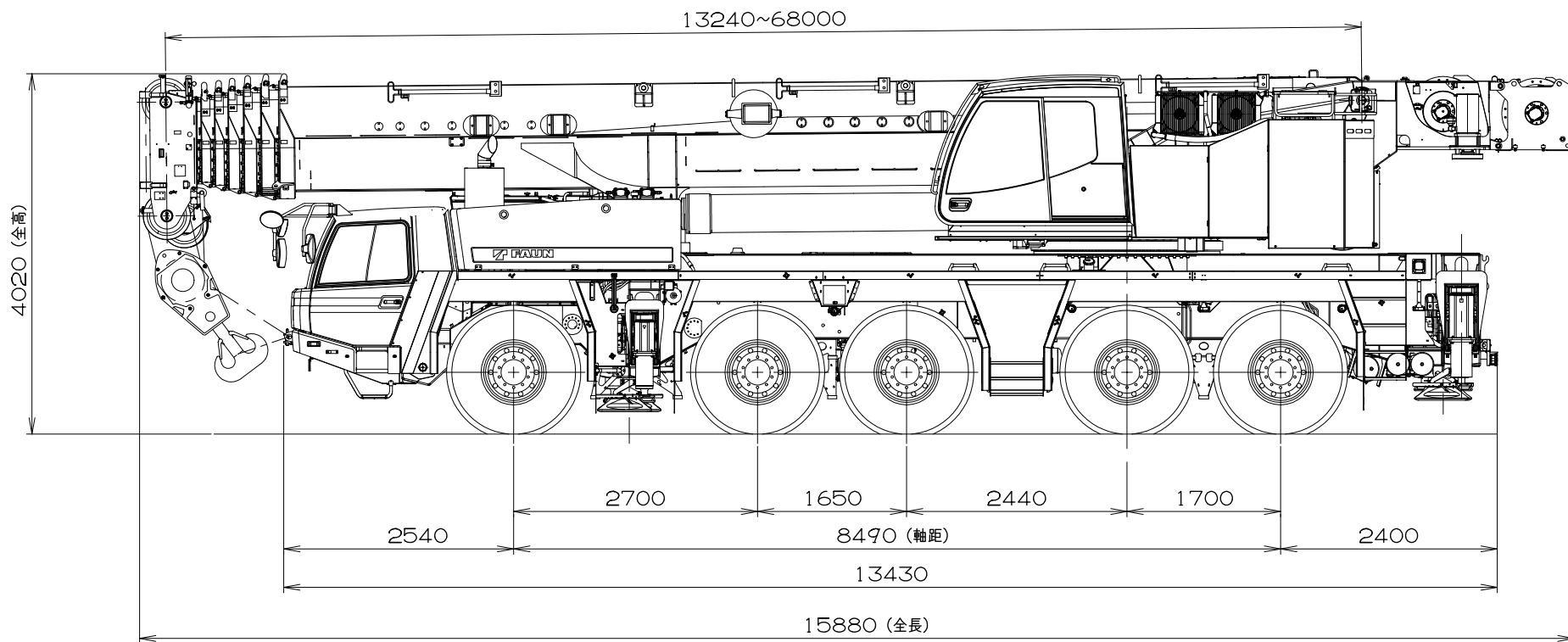
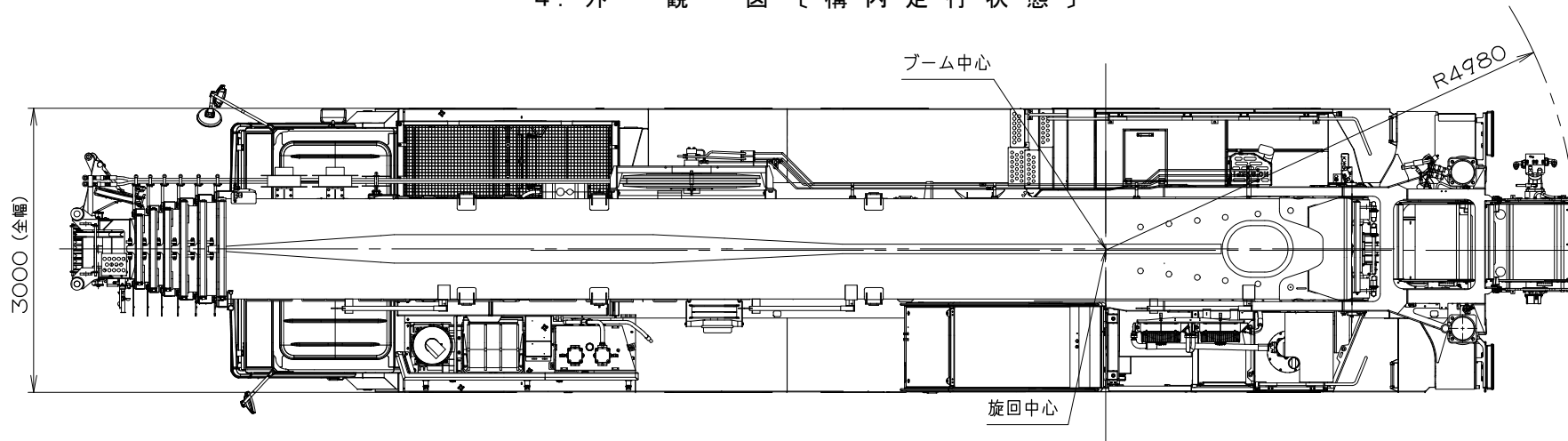

タダノ オールテレーンクレーン
ATF220G-5 型
フルオートラフィングジブ

仕 様 書

キャリア FAUN ATF220G-5
スペック番号 ATF-220G-1-90101

本仕様書は「フルオートラフィングジブ」についてのみ示したものです。
管理番号 JA-B-01 の仕様書とあわせてご覧ください。

株式会社 タダノ

フルオートラフティングジブ 主要諸元

クレーン容量	8.5m ジブ	27,500 kg × 7.0 m (4本掛)
	11.6m ジブ	14,600 kg × 16.0 m (2本掛)
	14.7m ジブ	13,900 kg × 12.0 m (2本掛)
	17.8m ジブ	13,500 kg × 8.0 m (2本掛)
	20.9m ジブ	5,600 kg × 34.0 m (1本掛)
ジブ形式	箱型3段同時伸縮式 オフセット5°~60°油圧無段階傾斜式 1.85m(固定部)+ 8.5m~20.9m(起伏部・伸縮部)	
ジブ伸縮装置	複動油圧シリンダ直押式 1本 ワイヤロープ式伸縮装置 1基	
ジブ長さ	8.5 m 11.6 m 14.7 m 17.8 m 20.9 m	
最大地上揚程	86.0 m	
最大作業半径	60.0 m	

フルオートラフィングジブ 定格総荷重表

1. 定格総荷重は、アウトリガを水平堅土上に設置したときの値で、太線より上側はクレーンの強度に基づき、下側は、クレーンの安定に基づいています。
2. 定格総荷重表の性能区分 F A ~ F M は、下表のとおりです。

アウトリガ張出幅	71 t	47 t	35 t	23.5 t	12 t	0 t
8.3 m	F A	F B	F C	F D	F E	F F
7.0 m	F G	F H	F I	F J	F K	/
5.6 m	/	/	F L	F M	/	/

3. 定格総荷重表中のブーム長さにおける伸長状態は、下表のとおりです。

ブーム長さ	伸長状態 (伸長割合%)					
	伸縮ブーム1	伸縮ブーム2	伸縮ブーム3	伸縮ブーム4	伸縮ブーム5	伸縮ブーム6
30.0 m	92	92	0	0	0	0
34.1 m	92	92	46	0	0	0
38.3 m	92	92	92	0	0	0
42.5 m	92	92	92	46	0	0
46.7 m	92	92	92	92	0	0
50.9 m	92	92	92	92	46	0
55.0 m	92	92	92	92	92	0
59.2 m	92	92	92	92	92	46
63.4 m	92	92	92	92	92	92

4. Bピン(ブーム固定ピン)を挿入していないときの定格総荷重は、24.0 t に制限されます。
5. 定格総荷重は、つり具質量とフック質量(80 t フック : 1,150kg、25 t フック : 450kg、7.8 t フック : 300kg)を含んだ値を示します。
6. 定格総荷重は、ブーム、ジブのたわみを含んだ実際の作業半径に基づいています。
7. 各状態における標準フックとワイヤロープ標準巻掛本数は、定格総荷重表中に記載しています。
なお、ロープ1本当たりの荷重は、7.8 t 以下です。
8. 定格総荷重表は、風による影響を含んでいません。瞬間最大風速が 10m / s (63.4m ブーム時は 7m / s) 以上の風速では、クレーン作業を中止してください。
9. 定格総荷重表中の は、無負荷時のブーム起伏角度範囲です。

FA性能

30.0mブーム+1.85m+フルオートラフィングジブ

単位：t

ジブ長さ(m)	8.5					11.6					14.7					17.8					20.9					
	オフセット					オフセット					オフセット					オフセット					オフセット					
	5°	15°	30°	45°	60°	5°	15°	30°	45°	60°	5°	15°	30°	45°	60°	5°	15°	30°	45°	60°	5°	15°	30°	45°	60°	
7.0	26.1	20.9				14.6					13.9															
8.0	24.4	19.9				14.6	14.6				13.9					13.5										
9.0	22.8	19.0	15.8			14.6	14.6				13.9					13.4						5.6				
10.0	21.5	18.2	15.3	13.6		14.6	14.5				13.9	12.4				13.0						5.6				
11.0	20.3	17.4	14.9	13.3	12.2	14.6	13.8	11.5			13.9	11.8				12.5	10.2					5.6				
12.0	19.2	16.7	14.5	13.1	12.1	14.6	13.2	11.2			13.4	11.3				11.7	9.8					5.6				
14.0	17.3	15.5	13.8	12.7	11.9	13.9	12.2	10.6	9.5	8.6	12.0	10.3	8.8			10.4	8.9					5.6	5.6			
16.0	15.8	14.4	13.2	12.4	11.8	12.6	11.3	10.0	9.2	8.5	10.8	9.5	8.3	7.4		9.3	8.2	7.0				5.6	5.6			
18.0	14.5	13.5	12.6	12.1	11.7	11.5	10.5	9.6	8.9	8.4	9.8	8.8	7.8	7.1	6.5	8.4	7.6	6.6	5.8			5.6	5.6	5.6		
20.0	13.4	12.7	12.1	11.9		10.5	9.8	9.1	8.7	8.3	8.9	8.2	7.5	6.9	6.4	7.7	7.0	6.3	5.6	5.0		5.6	5.6	5.6		
22.0	12.4	12.0	11.7	11.7		9.7	9.2	8.8	8.5	8.3	8.2	7.7	7.1	6.7	6.3	7.0	6.5	6.0	5.4	4.9		5.6	5.6	5.3	4.6	
24.0	11.6	11.4	11.4	11.6		9.0	8.7	8.4	8.3		7.6	7.2	6.8	6.5	6.3	6.5	6.1	5.7	5.3	4.8		5.6	5.5	5.0	4.5	4.0
26.0	10.9	10.9	11.1	11.6		8.4	8.3	8.2	8.2		7.0	6.8	6.6	6.4		6.0	5.7	5.4	5.1	4.8		5.4	5.2	4.8	4.3	3.9
28.0	10.3	10.5	10.9			7.9	7.9	7.9	8.1		6.5	6.4	6.3	6.3		5.5	5.4	5.2	5.0			5.0	4.8	4.6	4.2	3.9
30.0	9.7	10.1	10.8			7.4	7.5	7.7			6.1	6.1	6.1	6.2		5.2	5.1	5.0	4.9			4.7	4.6	4.4	4.1	3.8
32.0	9.2	9.8	10.0			7.0	7.2	7.6			5.7	5.8	6.0			4.8	4.8	4.9	4.8			4.3	4.3	4.2	4.0	
34.0	8.1	8.2				6.6	7.0	7.5			5.4	5.6	5.8			4.5	4.6	4.7	4.8			4.1	4.1	4.1	3.9	
36.0	6.7					6.3	6.7				5.1	5.3	5.7			4.3	4.4	4.6				3.8	3.9	3.9	3.8	
38.0						6.0	6.6				4.8	5.2	5.7			4.0	4.2	4.5				3.6	3.7	3.8		
40.0						5.5					4.6	5.0				3.8	4.1	4.4				3.4	3.5	3.7		
42.0											4.4					3.6	3.9					3.2	3.4	3.6		
44.0																3.5	3.8					3.0	3.2	3.6		
46.0																3.3						2.8	3.1			
48.0																						2.7	3.1			
(°)	10-84	20-84	34-84	50-84	65-84	10-84	20-84	35-84	50-84	65-84	10-84	20-84	35-84	51-84	66-84	10-84	20-84	35-84	51-84	67-84	10-84	20-84	35-84	52-84	68-84	
標準フック	80t					25t										7.8t										
フック質量	1150kg					450kg										300kg										
標準巻掛本数	4					2										1										

注) カウンタウエイト71t、アウトリガ張出幅 8.3m

FA性能

34.1mブーム+1.85m+フルオートラフィングジブ

単位：t

ジブ長さ(m)	8.5					11.6					14.7					17.8					20.9					
	オフセット					オフセット					オフセット					オフセット					オフセット					
	5°	15°	30°	45°	60°	5°	15°	30°	45°	60°	5°	15°	30°	45°	60°	5°	15°	30°	45°	60°	5°	15°	30°	45°	60°	
7.0	27.5	21.5				14.6																				
8.0	25.8	20.5				14.6					13.9					13.5										
9.0	24.2	19.7	16.0			14.6	14.6				13.9					13.2										
10.0	22.8	18.8	15.6			14.6	14.6				13.9	12.8				12.8										
11.0	21.6	18.1	15.2	13.4		14.6	14.6	11.9			13.9	12.2				12.4	10.5					5.6				
12.0	20.5	17.4	14.8	13.2	12.1	14.6	14.1	11.6			13.9	11.7				12.0	10.0					5.6				
14.0	18.5	16.2	14.1	12.8	11.9	14.6	13.0	11.0	9.7		12.8	10.7	8.9			11.0	9.2					5.6	5.6			
16.0	16.9	15.1	13.5	12.5	11.8	13.9	12.1	10.4	9.4	8.6	11.5	9.9	8.4	7.4		9.9	8.5	7.1				5.6	5.6			
18.0	15.6	14.2	12.9	12.2	11.7	12.6	11.3	10.0	9.1	8.4	10.4	9.2	8.0	7.2	6.5	9.0	7.8	6.7				5.6	5.6	5.6		
20.0	14.4	13.4	12.5	12.0	11.7	11.6	10.6	9.5	8.9	8.4	9.6	8.6	7.6	6.9	6.4	8.2	7.3	6.4	5.6			5.6	5.6	5.6		
22.0	13.4	12.7	12.0	11.8		10.7	9.9	9.2	8.7	8.3	8.8	8.1	7.3	6.7	6.3	7.5	6.8	6.1	5.5	4.9		5.6	5.6	5.4	4.6	
24.0	12.5	12.0	11.7	11.6		10.0	9.4	8.8	8.5		8.1	7.6	7.0	6.6	6.2	6.9	6.4	5.8	5.3	4.8		5.6	5.6	5.1	4.5	3.9
26.0	11.7	11.5	11.4	11.5		9.3	8.9	8.5	8.4		7.5	7.1	6.7	6.4	6.2	6.4	6.0	5.6	5.2	4.7		5.6	5.4	4.9	4.3	3.9
28.0	11.1	11.0	11.1	11.5		8.7	8.5	8.3	8.2		7.0	6.8	6.5	6.3		5.9	5.7	5.3	5.0	4.7		5.4	5.1	4.7	4.2	3.8
30.0	10.5	10.6	10.9			8.2	8.1	8.1	8.2		6.6	6.4	6.3	6.2		5.5	5.4	5.1	4.9			5.0	4.8	4.5	4.1	3.8
32.0	9.5	9.6	9.7			7.7	7.7	7.9			6.2	6.1	6.1	6.1		5.2	5.1	5.0	4.8			4.7	4.5	4.3	4.0	
34.0	8.1	8.3	8.5			7.3	7.4	7.7			5.8	5.8	5.9	6.1		4.9	4.8	4.8	4.8			4.4	4.3	4.1	3.9	
36.0	6.7	6.9				6.9	7.2	7.6			5.5	5.6	5.8			4.6	4.6	4.7	4.7			4.1	4.1	4.0	3.8	
38.0	5.5	5.6				6.6	6.8				5.2	5.4	5.7			4.3	4.4	4.5				3.8	3.9	3.9	3.8	
40.0	4.4					5.5	5.7				4.9	5.2	5.6			4.1	4.2	4.4				3.6	3.7	3.8	3.7	
42.0						4.5	4.6				4.7	5.0				3.9	4.1	4.4				3.4	3.5	3.7		
44.0						3.6					4.5	4.6				3.7	3.9	4.3				3.2	3.4	3.6		
46.0											3.6					3.5	3.8					3.0	3.2	3.5		
48.0																3.4	3.7					2.9	3.1			
50.0																2.9						2.8	3.0			
(°)	10-84	20-84	35-84	51-84	66-84	10-84	20-84	37-84	52-84	66-84	10-84	20-84	35-84	51-84	66-84	10-84	20-84	35-84	51-84	67-84	10-84	20-84	35-84	52-84	68-84	
標準フック	80t					25t										7.8t										
フック質量	1150kg					450kg										300kg										
標準巻掛本数	4					2										1										

注) カウンタウエイト71t、アウトリガ張出幅 8.3m

F A 性能

3 8 . 3 mブーム+ 1 . 8 5 m+フルオートラフィングジブ

単位 : t

ジブ長さ(m) 作業半径(m)	8.5					11.6					14.7					17.8					20.9				
	オフセット					オフセット					オフセット					オフセット					オフセット				
	5°	15°	30°	45°	60°	5°	15°	30°	45°	60°	5°	15°	30°	45°	60°	5°	15°	30°	45°	60°	5°	15°	30°	45°	60°
7.0	25.0																								
8.0	25.0	21.6				14.6																			
9.0	25.0	20.7				14.6					13.9				12.9										
10.0	24.7	19.9	16.1			14.6	14.6				13.9				12.6										
11.0	23.4	19.1	15.7			14.6	14.6				13.9	12.6			12.2						5.6				
12.0	22.2	18.4	15.3	13.5	12.2	14.6	14.6	11.8			13.9	12.1			11.8	10.1					5.6				
14.0	20.2	17.2	14.6	13.1	12.1	14.6	13.6	11.2	9.8		13.6	11.1	9.1		11.1	9.5					5.6				
16.0	18.4	16.1	14.0	12.8	11.9	14.6	12.6	10.7	9.5	8.6	12.3	10.3	8.6		10.6	8.8	7.2				5.6	5.6			
18.0	17.0	15.1	13.5	12.5	11.8	13.5	11.8	10.2	9.2	8.5	11.2	9.6	8.2	7.3		9.6	8.2	6.9			5.6	5.6			
20.0	15.7	14.3	13.0	12.2	11.8	12.5	11.1	9.8	9.0	8.4	10.2	9.0	7.8	7.0	6.4	8.8	7.6	6.5	5.7		5.6	5.6	5.6		
22.0	14.6	13.5	12.6	12.0		11.5	10.5	9.4	8.8	8.3	9.4	8.5	7.5	6.8	6.3	8.0	7.1	6.2	5.5	4.9	5.6	5.6	5.5		
24.0	13.7	12.9	12.2	11.9		10.7	9.9	9.1	8.6	8.3	8.7	8.0	7.2	6.7	6.2	7.4	6.7	6.0	5.4	4.8	5.6	5.6	5.3	4.5	
26.0	12.9	12.3	11.8	11.7		10.0	9.4	8.8	8.5		8.1	7.5	6.9	6.5	6.2	6.9	6.3	5.7	5.2	4.8	5.6	5.6	5.0	4.4	3.9
28.0	11.5	11.7	11.5	11.6		9.4	8.9	8.5	8.3		7.6	7.1	6.7	6.4		6.4	6.0	5.5	5.1	4.7	5.6	5.3	4.8	4.3	3.8
30.0	10.2	10.3	10.5	10.6		8.8	8.5	8.3	8.2		7.1	6.8	6.5	6.3		6.0	5.7	5.3	5.0		5.4	5.0	4.6	4.2	3.8
32.0	9.0	9.1	9.3			8.3	8.2	8.1	8.2		6.7	6.5	6.3	6.2		5.6	5.4	5.1	4.9		5.0	4.8	4.4	4.1	3.8
34.0	7.9	8.1	8.2			7.9	7.8	7.9	8.1		6.3	6.2	6.1	6.1		5.3	5.1	5.0	4.8		4.7	4.5	4.3	4.0	
36.0	6.7	7.0	7.2			7.5	7.5	7.8			5.9	5.9	6.0	6.1		4.9	4.9	4.8	4.8		4.4	4.3	4.1	3.9	
38.0	5.5	5.7	5.8			6.5	6.8	7.0			5.6	5.7	5.8			4.7	4.7	4.7	4.7		4.2	4.1	4.0	3.8	
40.0	4.4	4.6				5.4	5.7	5.9			5.4	5.5	5.7			4.4	4.5	4.6			3.9	3.9	3.9	3.8	
42.0	3.5	3.5				4.4	4.6				5.1	5.3	5.6			4.2	4.3	4.5			3.7	3.7	3.8	3.7	
44.0	2.6					3.5	3.7				4.3	4.6	4.8			4.0	4.1	4.4			3.5	3.6	3.7		
46.0						2.7	2.8				3.5	3.7				3.8	4.0	4.3			3.3	3.4	3.6		
48.0						2.0					2.8	2.9				3.4	3.7				3.2	3.3	3.5		
50.0											2.1					2.8	2.9				3.0	3.2	3.5		
55.0																					2.1	2.2			
(°)	10-84	20-84	35-84	51-84	67-84	10-84	20-84	35-84	51-84	67-84	10-84	20-84	35-84	51-84	67-84	10-84	20-84	35-84	52-84	68-84	10-84	20-84	35-84	52-84	68-84
標準フック	80 t					25t					7.8t														
フック質量	1150kg					450kg					300kg														
標準巻掛本数	4					2					1														

注)カウンタウエイト71t、アウトリガ張幅 8.3m

F A 性能

4 2 . 5 mブーム+ 1 . 8 5 m+フルオートラフィングジブ

単位 : t

ジブ長さ(m) 作業半径(m)	8.5					11.6					14.7					17.8					20.9				
	オフセット					オフセット					オフセット					オフセット					オフセット				
	5°	15°	30°	45°	60°	5°	15°	30°	45°	60°	5°	15°	30°	45°	60°	5°	15°	30°	45°	60°	5°	15°	30°	45°	60°
8.0	21.3																								
9.0	21.3	21.3				14.6																			
10.0	21.3	20.5				14.6					13.9				11.5										
11.0	21.3	19.7	15.9			14.6	14.6				13.9				11.5										
12.0	21.0	19.0	15.6	13.6		14.6	14.6				13.8	12.0			11.5						5.6				
14.0	19.5	17.8	14.9	13.3	12.1	14.6	14.1	11.4			13.1	11.4			10.8	9.4					5.6				
16.0	18.1	16.7	14.3	12.9	12.0	14.6	13.1	10.9	9.6	8.6	12.4	10.7	8.8		10.2	8.9					5.6	5.6			
18.0	16.7	15.8	13.8	12.6	11.8	14.4	12.3	10.5	9.4	8.5	11.9	10.0	8.4	7.3		9.8	8.5	7.0			5.6	5.6			
20.0	15.4	14.9	13.3	12.4	11.8	13.3	11.6	10.1	9.1	8.4	10.9	9.4	8.0	7.1	6.4	9.3	7.9	6.7	5.8		5.6	5.6	5.6		
22.0	14.3	14.1	12.9	12.2	11.7	12.3	10.9	9.7	8.9	8.3	10.1	8.8	7.7	6.9	6.3	8.6	7.4	6.4	5.6	4.9	5.6	5.6	5.5		
24.0	13.2	13.1	12.5	12.0		11.5	10.4	9.4	8.7	8.3	9.3	8.3	7.4	6.8	6.3	7.9	7.0	6.1	5.4	4.8	5.6	5.6	5.3	4.6	
26.0	12.3	12.2	12.1	11.8		10.7	9.9	9.1	8.6	8.2	8.7	7.9	7.1	6.6	6.2	7.3	6.6	5.9	5.3	4.8	5.6	5.6	5.1	4.4	3.9
28.0	11.2	11.3	11.3	11.3		10.1	9.4	8.8	8.4		8.1	7.5	6.9	6.5	6.2	6.8	6.3	5.7	5.2	4.7	5.6	5.6	4.9	4.3	3.9
30.0	9.9	10.0	10.2	10.2		9.5	9.0	8.5	8.3		7.6	7.1	6.7	6.4		6.4	5.9	5.5	5.1	4.7	5.6	5.3	4.8	4.2	3.8
32.0	8.7	8.9	9.0	9.1		8.9	8.6	8.3	8.2		7.2	6.8	6.5	6.3		6.0	5.6	5.3	5.0		5.4	5.0	4.6	4.1	3.8
34.0	7.7	7.8	8.0			8.2	8.3	8.1	8.2		6.8	6.5	6.3	6.2		5.6	5.4	5.1	4.9		5.1	4.8	4.4	4.0	3.7
36.0	6.7	6.9	7.0			7.2	7.4	7.6	7.7		6.4	6.2	6.1	6.1		5.3	5.1	5.0	4.8		4.8	4.5	4.3	4.0	
38.0	5.7	5.9	6.1			6.4	6.6	6.8			6.1	6.0	6.0	6.1		5.0	4.9	4.8	4.8		4.5	4.3	4.1	3.9	
40.0	4.6	4.8	5.0			5.5	5.8	6.0			5.8	5.8	5.9			4.8	4.7	4.7	4.7		4.2	4.1	4.0	3.8	
42.0	3.7	3.8	3.9			4.6	4.8	5.1			5.3	5.5	5.7			4.5	4.5	4.6	4.7		4.0	4.0	3.9	3.8	
44.0	2.8	2.9				3.7	3.9	4.1			4.4	4.7	5.1			4.3	4.4	4.5			3.8	3.8	3.8	3.7	
46.0	2.0	2.1				2.9	3.0				3.6	3.9	4.1			4.1	4.2	4.4			3.6	3.6	3.7		
48.0	1.3					2.1	2.3				2.9	3.1	3.3			3.5	3.8	4.1			3.4	3.5	3.6		
50.0						1.5	1.5				2.2	2.4				2.8	3.1	3.3			3.2	3.4	3.6		
55.0																					2.1	2.3			
(°)	10-84	20-84	35-84	51-84	67-84	10-84	20-84	35-84	51-84	67-84	10-84	20-84	35-84	51-84	67-84	10-84	20-84	35-84	52-84	68-84	10-84	20-84	35-84	52-84	68-84
標準フック	25 t					25t					7.8t														
フック質量	450kg					450kg					300kg														
標準巻掛本数	3					2					1														

注)カウンタウエイト71t、アウトリガ張幅 8.3m

F A性能

46.7mブーム+1.85m+フルオートラフィングジブ

単位：t

ジブ長さ(m)	8.5					11.6					14.7					17.8					20.9					
	オフセット					オフセット					オフセット					オフセット					オフセット					
	5°	15°	30°	45°	60°	5°	15°	30°	45°	60°	5°	15°	30°	45°	60°	5°	15°	30°	45°	60°	5°	15°	30°	45°	60°	
9.0	17.5																									
10.0	17.5	17.5				14.2																				
11.0	17.5	17.5				14.2					12.0					10.1										
12.0	17.5	17.5	15.8			14.2	14.2				12.0					10.1										
14.0	16.9	16.4	15.2	13.4		14.2	14.0	11.6			12.0	11.1				10.1	9.1					5.6				
16.0	15.5	15.1	14.6	13.1	12.0	14.2	13.6	11.1	9.7		12.0	10.6	8.9			9.9	8.7					5.6				
18.0	14.3	14.0	13.7	12.8	11.9	13.4	12.8	10.7	9.5	8.5	11.5	10.2	8.5			9.4	8.3	7.0				5.6	5.6			
20.0	13.2	13.0	12.7	12.5	11.8	12.5	12.1	10.3	9.2	8.4	11.2	9.7	8.2	7.2	6.4	9.0	8.0	6.8				5.6	5.6			
22.0	12.3	12.1	11.8	11.8	11.7	11.6	11.4	9.9	9.0	8.4	10.7	9.2	7.9	7.0	6.4	8.8	7.6	6.5	5.6			5.6	5.6	5.4		
24.0	11.4	11.2	11.1	11.0		10.8	10.6	9.6	8.8	8.3	9.9	8.7	7.6	6.8	6.3	8.4	7.3	6.2	5.5	4.8		5.6	5.6	5.2		
26.0	10.6	10.5	10.3	10.3		10.1	9.9	9.3	8.7	8.3	9.2	8.2	7.3	6.7	6.2	7.8	6.9	6.0	5.4	4.8		5.6	5.6	5.1	4.5	
28.0	9.8	9.8	9.7	9.7		9.5	9.3	9.0	8.5		8.6	7.8	7.1	6.6	6.2	7.3	6.5	5.8	5.2	4.7		5.6	5.6	4.9	4.4	3.9
30.0	9.1	9.1	9.1	9.1		8.9	8.8	8.6	8.4		8.1	7.5	6.8	6.4	6.1	6.8	6.2	5.6	5.1	4.7		5.6	5.4	4.7	4.3	3.8
32.0	8.3	8.5	8.5	8.5		8.3	8.2	8.1	8.1		7.6	7.1	6.6	6.3		6.4	5.9	5.4	5.0	4.7		5.6	5.2	4.6	4.2	3.8
34.0	7.4	7.5	7.6	7.7		7.7	7.7	7.7	7.7		7.2	6.8	6.5	6.2		6.0	5.6	5.2	4.9			5.4	5.0	4.5	4.1	3.7
36.0	6.5	6.6	6.7			6.9	7.1	7.2	7.3		6.8	6.5	6.3	6.2		5.7	5.4	5.1	4.9			5.1	4.8	4.4	4.0	
38.0	5.7	5.8	5.9			6.1	6.3	6.5	6.5		6.4	6.3	6.1	6.1		5.4	5.2	4.9	4.8			4.8	4.5	4.2	3.9	
40.0	4.8	5.0	5.2			5.4	5.5	5.7			5.7	5.9	6.0	6.1		5.1	5.0	4.8	4.7			4.5	4.3	4.1	3.9	
42.0	3.8	4.0	4.2			4.7	4.9	5.0			5.1	5.2	5.4			4.8	4.8	4.7	4.7			4.3	4.2	4.0	3.8	
44.0	2.9	3.1	3.2			3.8	4.0	4.3			4.5	4.6	4.8			4.6	4.6	4.6	4.7			4.1	4.0	3.9	3.8	
46.0	2.2	2.3				3.0	3.2	3.4			3.7	4.0	4.2			4.2	4.4	4.5				3.9	3.8	3.8	3.7	
48.0	1.4	1.5				2.2	2.4	2.6			2.9	3.2	3.5			3.5	3.9	4.1				3.7	3.7	3.7	3.7	
50.0						1.6	1.7				2.2	2.5	2.7			2.8	3.1	3.5				3.5	3.6	3.7		
55.0																1.3	1.6					2.1	2.4	2.7		
60.0																							1.0			
(°)	10-84	20-84	35-84	52-84	68-84	10-84	20-84	35-84	52-84	68-84	10-84	20-84	35-84	52-84	68-84	10-84	20-84	35-84	52-84	68-84	10-84	20-84	35-84	52-84	68-84	69-84
標準フック	25t					25t					25t					7.8t										
フック質量	450kg					450kg					450kg					300kg										
標準巻掛本数	3					2					1															

注) カウンタウエイト71t、アウトリガ張出幅 8.3m

F A性能

50.9mブーム+1.85m+フルオートラフィングジブ

単位：t

ジブ長さ(m)	8.5					11.6					14.7					17.8					20.9					
	オフセット					オフセット					オフセット					オフセット					オフセット					
	5°	15°	30°	45°	60°	5°	15°	30°	45°	60°	5°	15°	30°	45°	60°	5°	15°	30°	45°	60°	5°	15°	30°	45°	60°	
10.0	13.8																									
11.0	13.8	13.8				11.8																				
12.0	13.8	13.8				11.8					10.1															
14.0	13.8	13.8	13.3	13.0		11.8	11.8				10.1	10.1				6.7										
16.0	13.4	13.0	12.5	12.2	12.1	11.8	11.8	11.3			10.1	10.0				6.7							5.6			
18.0	12.3	12.1	11.7	11.5	11.4	11.5	11.2	10.7	9.5		10.1	9.6	8.4			6.7	6.7					5.6	5.6			
20.0	11.4	11.2	11.0	10.8	10.8	10.9	10.5	10.1	9.3	8.5	10.0	9.5	8.2	7.3		6.7	6.7	6.7				5.6	5.6			
22.0	10.5	10.4	10.3	10.2	10.2	10.1	9.9	9.5	9.1	8.4	9.4	9.1	7.9	7.1	6.4	6.7	6.7	6.5				5.6	5.6	5.3		
24.0	9.8	9.7	9.6	9.6	9.6	9.4	9.3	9.0	8.9	8.3	9.1	8.7	7.7	6.9	6.3	6.7	6.7	6.3	5.7			5.6	5.6	5.1		
26.0	9.1	9.0	8.9	8.9		8.8	8.7	8.5	8.4	8.3	8.5	8.2	7.4	6.8	6.2	6.7	6.7	6.1	5.6	5.0		5.6	5.6	5.0	4.5	
28.0	8.5	8.4	8.3	8.3		8.2	8.1	8.0	8.0		7.9	7.8	7.2	6.6	6.2	6.7	6.7	5.9	5.5	5.0		5.6	5.5	4.8	4.4	3.9
30.0	7.9	7.9	7.8	7.8		7.7	7.6	7.5	7.5		7.4	7.3	7.0	6.5	6.1	6.7	6.5	5.7	5.3	4.9		5.6	5.3	4.7	4.3	3.8
32.0	7.4	7.4	7.3	7.3		7.2	7.1	7.1	7.1		7.0	6.9	6.8	6.4		6.6	6.3	5.6	5.2	4.9		5.6	5.2	4.5	4.2	3.8
34.0	6.9	6.9	6.8	6.8		6.7	6.7	6.6	6.6		6.5	6.5	6.4	6.3		6.2	6.1	5.4	5.1			5.6	5.0	4.4	4.1	3.8
36.0	6.4	6.4	6.4	6.4		6.3	6.3	6.2	6.2		6.1	6.1	6.1	6.1		5.9	5.8	5.3	5.0			5.4	4.8	4.3	4.0	3.7
38.0	5.6	5.7	5.8			5.9	5.9	5.9	5.9		5.8	5.7	5.7	5.7		5.5	5.5	5.2	4.9			5.1	4.7	4.2	3.9	
40.0	4.9	5.0	5.1			5.2	5.4	5.5			5.4	5.4	5.4	5.4		5.2	5.2	5.1	4.9			4.8	4.5	4.1	3.9	
42.0	4.2	4.3	4.4			4.6	4.7	4.9			4.9	5.0	5.1	5.1		4.9	4.9	4.9	4.8			4.6	4.4	4.0	3.8	
44.0	3.3	3.5	3.7			4.0	4.1	4.3			4.3	4.5	4.6			4.7	4.6	4.6	4.7			4.3	4.2	3.9	3.7	
46.0	2.5	2.7	2.8			3.2	3.5	3.7			3.8	3.9	4.1			4.2	4.4	4.4				4.1	4.0	3.8	3.7	
48.0	1.8	1.9				2.5	2.7	2.9			3.1	3.4	3.6			3.7	3.9	4.1				3.9	3.9	3.7	3.6	
50.0	1.1	1.2				1.8	2.0	2.2			2.4	2.7	3.0			3.1	3.4	3.6				3.5	3.7	3.7		
55.0											1.0	1.2				1.6	1.9	2.2				2.2	2.6	2.9		
60.0																						1.0	1.2			
(°)	10-84	20-84	38-84	54-84	69-84	10-84	20-84	38-84	54-84	69-84	33-84	20-84	38-84	54-84	69-84	37-84	20-84	38-84	54-84	69-84	34-84	20-84	38-84	54-84	69-84	69-84
標準フック	25t					25t					7.8t															
フック質量	450kg					450kg					300kg															
標準巻掛本数	2					1																				

注) カウンタウエイト71t、アウトリガ張出幅 8.3m

F A 性能

55.0mブーム+1.85m+フルオートラフィングジブ

単位：t

ジブ長さ(m) 作業半径(m)	8.5					11.6					14.7					17.8					20.9				
	オフセット					オフセット					オフセット					オフセット					オフセット				
	5°	15°	30°	45°	60°	5°	15°	30°	45°	60°	5°	15°	30°	45°	60°	5°	15°	30°	45°	60°	5°	15°	30°	45°	60°
11.0	11.5																								
12.0	11.5	11.5				10.0																			
14.0	11.5	11.5	11.4			10.0	10.0				6.9					6.7									
16.0	11.2	11.0	10.6	10.4	10.4	10.0	9.9	9.7			6.9					6.7					5.6				
18.0	10.5	10.2	9.9	9.7	9.7	9.6	9.5	9.1	8.9		6.9	6.9				6.7	6.7				5.6				
20.0	9.8	9.6	9.3	9.1	9.1	9.3	8.9	8.6	8.4	8.4	6.9	6.9	6.9			6.7	6.7				5.6	5.6			
22.0	9.2	9.0	8.7	8.6	8.6	8.7	8.4	8.1	8.0	8.0	6.9	6.9	6.9	6.9		6.7	6.7	6.3			5.6	5.6			
24.0	8.5	8.4	8.2	8.1	8.1	8.1	7.9	7.6	7.5	7.5	6.9	6.9	6.9	6.9	6.4	6.7	6.7	6.1	5.6		5.6	5.6	5.0		
26.0	7.9	7.8	7.7	7.6	7.6	7.6	7.4	7.2	7.1	7.1	6.9	6.9	6.7	6.6	6.3	6.6	6.5	5.9	5.5	5.1	5.6	5.6	4.8		
28.0	7.3	7.3	7.2	7.2		7.1	7.0	6.8	6.7	6.7	6.7	6.5	6.3	6.2	6.2	6.4	6.2	5.8	5.4	5.0	5.6	5.4	4.7	4.3	
30.0	6.8	6.8	6.7	6.7		6.6	6.6	6.4	6.4		6.3	6.2	6.0	5.9	5.9	6.0	5.9	5.6	5.2	4.9	5.5	5.2	4.6	4.2	3.9
32.0	6.3	6.3	6.3	6.3		6.2	6.2	6.1	6.1		6.0	5.8	5.7	5.6	5.6	5.7	5.5	5.4	5.1	4.9	5.3	5.0	4.4	4.1	3.8
34.0	5.9	5.9	5.9	5.9		5.8	5.8	5.8	5.7		5.6	5.5	5.4	5.3		5.4	5.3	5.1	5.0	4.9	5.2	4.9	4.3	4.0	3.8
36.0	5.5	5.5	5.5	5.5		5.4	5.4	5.4	5.4		5.2	5.2	5.1	5.1		5.1	5.0	4.9	4.8		4.9	4.7	4.2	4.0	3.7
38.0	5.1	5.1	5.1	5.1		5.1	5.0	5.0	5.1		4.9	4.9	4.9	4.8		4.8	4.8	4.6	4.6		4.7	4.5	4.1	3.9	3.7
40.0	4.7	4.8	4.8			4.7	4.7	4.7	4.7		4.6	4.6	4.6	4.6		4.5	4.5	4.4	4.4		4.4	4.3	4.0	3.8	
42.0	4.1	4.1	4.3			4.4	4.4	4.4			4.3	4.3	4.3	4.3		4.2	4.2	4.2	4.2		4.2	4.1	3.9	3.7	
44.0	3.5	3.6	3.7			3.8	4.0	4.1			4.0	4.0	4.0	4.1		4.0	4.0	4.0	4.0		3.9	3.9	3.8	3.7	
46.0	2.8	3.0	3.1			3.3	3.4	3.6			3.5	3.8	3.8			3.7	3.7	3.8	3.8		3.7	3.7	3.7	3.6	
48.0	2.1	2.2	2.4			2.7	2.9	3.1			3.3	3.3	3.6			3.5	3.5	3.5			3.5	3.5	3.5	3.5	
50.0	1.4	1.5				2.0	2.2	2.5			2.8	3.0	3.1			3.1	3.2	3.3			3.3	3.3	3.3	3.4	
55.0											1.3	1.5	1.7			1.8	2.1	2.4			2.3	2.5	2.7		
60.0																					1.1	1.4	1.7		
(°)	38-84	38-84	40-84	55-84	69-84	41-84	42-84	40-84	55-84	69-84	38-84	40-84	40-84	55-84	69-84	41-84	43-84	40-84	55-84	69-84	38-84	41-84	40-84	55-84	69-84
標準フック	25t										7.8t														
フック質量	450kg										300kg														
標準巻掛本数	2										1														

注) カウンタウエイト71t、アウトリガ張出幅 8.3m

F A 性能

59.2mブーム+1.85m+フルオートラフィングジブ

単位：t

ジブ長さ(m) 作業半径(m)	8.5					11.6					14.7					17.8					20.9					
	オフセット					オフセット					オフセット					オフセット					オフセット					
	5°	15°	30°	45°	60°	5°	15°	30°	45°	60°	5°	15°	30°	45°	60°	5°	15°	30°	45°	60°	5°	15°	30°	45°	60°	
11.0	9.6																									
12.0	9.6	9.4				7.5																				
14.0	9.0	8.7	8.3			7.5	7.5				6.5					5.7					5.0					
16.0	8.4	8.3	7.7	7.5		7.5	7.4				6.5	6.5				5.7					5.0					
18.0	8.1	7.8	7.3	7.1	7.0	7.2	6.9	6.5			6.5	6.3				5.7	5.7				5.0					
20.0	7.5	7.3	6.9	6.7	6.6	7.0	6.5	6.1	5.9		6.3	6.0	5.5			5.7	5.5				5.0	5.0				
22.0	7.1	6.8	6.6	6.3	6.3	6.5	6.2	5.8	5.6	5.5	5.9	5.6	5.2	5.0		5.5	5.2	4.8			5.0	4.8				
24.0	6.6	6.4	6.2	6.0	6.0	6.1	5.9	5.5	5.3	5.3	5.7	5.3	5.0	4.8	4.7	5.2	4.9	4.6			4.8	4.5	4.2			
26.0	6.2	6.0	5.8	5.7	5.7	5.8	5.6	5.2	5.0	5.0	5.4	5.1	4.8	4.6	4.5	5.0	4.7	4.4	4.2		4.6	4.3	4.0			
28.0	5.9	5.7	5.5	5.4		5.4	5.2	5.0	4.8	4.8	5.1	4.8	4.5	4.4	4.3	4.8	4.4	4.2	4.0	3.9	4.3	4.1	3.8	3.6		
30.0	5.5	5.4	5.2	5.1		5.1	5.0	4.8	4.6		4.8	4.6	4.3	4.2	4.2	4.5	4.2	4.0	3.8	3.8	4.2	3.9	3.6	3.5		
32.0	5.2	5.1	4.9	4.9		4.9	4.7	4.5	4.4		4.5	4.4	4.1	4.0	4.0	4.3	4.0	3.8	3.7	3.6	4.0	3.7	3.5	3.3	3.3	
34.0	4.9	4.8	4.7	4.6		4.6	4.4	4.3	4.2		4.3	4.1	3.9	3.8		4.1	3.9	3.6	3.5	3.5	3.8	3.5	3.3	3.2	3.2	
36.0	4.7	4.6	4.4	4.4		4.3	4.2	4.1	4.0		4.1	3.9	3.8	3.7		3.8	3.7	3.4	3.3		3.6	3.4	3.2	3.1	3.1	
38.0	4.4	4.3	4.2	4.2		4.1	4.0	3.9	3.8		3.9	3.7	3.6	3.5		3.6	3.5	3.3	3.2		3.4	3.2	3.0	3.0	3.0	
40.0	4.1	4.1	4.0			3.9	3.8	3.7	3.7		3.7	3.5	3.4	3.4		3.5	3.3	3.2	3.1		3.3	3.1	2.9	2.8		
42.0	3.8	3.8	3.8			3.7	3.6	3.5	3.5		3.5	3.4	3.3	3.2		3.3	3.2	3.1	3.0		3.1	3.0	2.8	2.7		
44.0	3.3	3.3	3.6			3.5	3.4	3.4			3.3	3.2	3.1	3.1		3.1	3.0	2.9	2.9		2.9	2.8	2.7	2.6		
46.0	2.9	3.0	3.1			3.1	3.3	3.2			3.2	3.1	3.0			3.0	2.9	2.8	2.8		2.8	2.7	2.6	2.5		
48.0	2.4	2.6	2.6			2.8	2.9	3.1			2.8	2.9	2.8			2.8	2.7	2.7	2.6		2.7	2.6	2.5	2.4		
50.0	1.7	1.9	2.0			2.5	2.6	2.7			2.6	2.6	2.7			2.7	2.6	2.5			2.5	2.5	2.4	2.4		
55.0						1.0	1.2				1.5	1.8	2.0			2.0	2.2	2.1			2.1	2.2	2.1			
60.0																	1.0					1.3	1.6	1.8		
(°)	42-84	43-84	43-84	57-84	70-84	39-84	40-84	43-84	57-84	70-84	42-84	44-84	43-84	57-84	70-84	45-84	41-84	43-84	57-84	70-84	42-84	44-84	43-84	57-84	70-84	
標準フック	25t										7.8t															
フック質量	450kg										300kg															
標準巻掛本数	2										1															

注) カウンタウエイト71t、アウトリガ張出幅 8.3m

F A 性能

63.4mブーム+1.85m+フルオートラフィングジブ

単位：t

ジブ長さ(m) 作業半径(m)	8.5					11.6					14.7					17.8					20.9				
	オフセット					オフセット					オフセット					オフセット					オフセット				
	5°	15°	30°	45°	60°	5°	15°	30°	45°	60°	5°	15°	30°	45°	60°	5°	15°	30°	45°	60°	5°	15°	30°	45°	60°
14.0	7.0	7.0				6.1					5.4														
16.0	6.8	6.6	6.3			6.1	6.0				5.4					4.7									
18.0	6.3	6.1	5.9	5.7		5.9	5.7	5.3			5.4	5.2				4.7					4.2				
20.0	6.0	5.8	5.5	5.3	5.3	5.5	5.3	5.0	4.8		5.2	4.9				4.7	4.5				4.2				
22.0	5.6	5.4	5.1	5.0	5.0	5.2	5.0	4.7	4.5	4.5	4.8	4.6	4.3			4.6	4.3				4.2	4.0			
24.0	5.3	5.1	4.8	4.7	4.7	4.9	4.7	4.4	4.3	4.2	4.5	4.3	4.1	3.9		4.3	4.0	3.8			4.0	3.7			
26.0	4.9	4.8	4.6	4.4	4.4	4.6	4.4	4.2	4.1	4.0	4.3	4.1	3.9	3.7	3.7	4.0	3.8	3.6			3.8	3.5	3.3		
28.0	4.6	4.5	4.3	4.2	4.2	4.3	4.1	3.9	3.9	3.8	4.0	3.8	3.6	3.5	3.5	3.8	3.6	3.4	3.3	3.2	3.6	3.4	3.1		
30.0	4.3	4.2	4.1	4.0		4.1	3.9	3.7	3.6	3.6	3.8	3.6	3.5	3.3	3.3	3.6	3.4	3.2	3.1	3.1	3.3	3.2	3.0	2.9	
32.0	4.0	4.0	3.9	3.8		3.8	3.7	3.5	3.4		3.6	3.4	3.3	3.2	3.2	3.4	3.2	3.0	2.9	2.9	3.2	3.0	2.8	2.7	
34.0	3.8	3.7	3.6	3.6		3.6	3.5	3.3	3.3		3.4	3.2	3.1	3.0	3.0	3.2	3.0	2.9	2.8	2.8	3.0	2.9	2.7	2.6	
36.0	3.6	3.5	3.4	3.4		3.4	3.3	3.2	3.1		3.2	3.1	2.9	2.8		3.0	2.9	2.7	2.7	2.6	2.8	2.7	2.6	2.5	
38.0	3.3	3.3	3.2	3.2		3.2	3.1	3.0	2.9		3.0	2.9	2.8	2.7		2.9	2.7	2.6	2.5		2.7	2.5	2.4	2.3	
40.0	3.1	3.1	3.0	3.0		3.0	2.9	2.8	2.8		2.8	2.8	2.6	2.6		2.7	2.6	2.4	2.4		2.5	2.4	2.3	2.2	
42.0	3.0	2.9	2.8			2.8	2.7	2.7	2.6		2.7	2.6	2.5	2.4		2.5	2.4	2.3	2.3		2.4	2.3	2.2	2.1	
44.0	2.8	2.7	2.7			2.6	2.6	2.5	2.5		2.5	2.4	2.4	2.3		2.4	2.3	2.2	2.1		2.3	2.2	2.0	2.0	
46.0	2.4	2.6	2.5			2.5	2.4	2.4			2.4	2.3	2.3	2.2		2.3	2.2	2.1	2.0		2.2	2.1	1.9	1.9	
48.0	2.3	2.3	2.2			2.2	2.3	2.2			2.2	2.2	2.1			2.1	2.1	2.0	2.0		2.0	2.0	1.8	1.8	
50.0	2.1	2.1	2.1			2.0	2.0	2.1			2.1	2.0	2.0			2.0	1.9	1.9	1.9		1.9	1.9	1.8	1.7	
55.0						1.3	1.5	1.7			1.6	1.6	1.6			1.6	1.7	1.6			1.6	1.6	1.6		
60.0																1.0	1.3	1.3			1.3	1.2	1.3		
(°)	46-84	47-84	45-84	57-84	70-84	43-84	44-84	45-84	57-84	70-84	46-84	47-84	45-84	57-84	70-84	43-84	44-84	45-84	57-84	70-84	45-84	47-84	45-84	57-84	70-84
標準フック	7.8t																								
フック質量	300kg																								
標準巻掛本数	1																								

注) カウンタウエイト71t、アウトリガ張出幅 8.3m

F B 性能

30.0mブーム+1.85m+フルオートラフィングジブ

単位：t

ジブ長さ(m)	8.5					11.6					14.7					17.8					20.9				
	オフセット					オフセット					オフセット					オフセット					オフセット				
	5°	15°	30°	45°	60°	5°	15°	30°	45°	60°	5°	15°	30°	45°	60°	5°	15°	30°	45°	60°	5°	15°	30°	45°	60°
7.0	26.1	20.9				14.6					13.9														
8.0	24.4	19.9				14.6	14.6				13.9					13.5									
9.0	22.8	19.0	15.8			14.6	14.6				13.9					13.4						5.6			
10.0	21.5	18.2	15.3	13.6		14.6	14.5				13.9	12.4				13.0						5.6			
11.0	20.3	17.4	14.9	13.3	12.2	14.6	13.8	11.5			13.9	11.8				12.5	10.2					5.6			
12.0	19.2	16.7	14.5	13.1	12.1	14.6	13.2	11.2			13.4	11.3				11.7	9.8					5.6			
14.0	17.3	15.5	13.8	12.7	11.9	13.9	12.2	10.6	9.5	8.6	12.0	10.3	8.8			10.4	8.9					5.6	5.6		
16.0	15.8	14.4	13.2	12.4	11.8	12.6	11.3	10.0	9.2	8.5	10.8	9.5	8.3	7.4		9.3	8.2	7.0				5.6	5.6		
18.0	14.5	13.5	12.6	12.1	11.7	11.5	10.5	9.6	8.9	8.4	9.8	8.8	7.8	7.1	6.5	8.4	7.6	6.6	5.8			5.6	5.6	5.6	
20.0	13.4	12.7	12.1	11.9		10.5	9.8	9.1	8.7	8.3	8.9	8.2	7.5	6.9	6.4	7.7	7.0	6.3	5.6	5.0		5.6	5.6	5.6	
22.0	12.4	12.0	11.7	11.7		9.7	9.2	8.8	8.5	8.3	8.2	7.7	7.1	6.7	6.3	7.0	6.5	6.0	5.4	4.9		5.6	5.6	5.3	
24.0	11.6	11.4	11.4	11.6		9.0	8.7	8.4	8.3		7.6	7.2	6.8	6.5	6.3	6.5	6.1	5.7	5.3	4.8		5.6	5.5	5.0	
26.0	9.5	10.0	10.4	10.6		8.4	8.3	8.2	8.2		7.0	6.8	6.6	6.4		6.0	5.7	5.4	5.1	4.8		5.4	5.2	4.8	
28.0	7.6	7.9	8.3			7.9	7.9	7.9	8.1		6.5	6.4	6.3	6.3		5.5	5.4	5.2	5.0			5.0	4.8	4.6	
30.0	5.9	6.2	6.4			7.2	7.5	7.7			6.1	6.1	6.1	6.2		5.2	5.1	5.0	4.9			4.7	4.6	4.4	
32.0	4.5	4.7	4.8			5.8	6.1	6.5			5.7	5.8	6.0			4.8	4.8	4.9	4.8			4.3	4.3	4.2	
34.0	3.3	3.4				4.5	4.8	5.0			5.4	5.6	5.8			4.5	4.6	4.7	4.8			4.1	4.1	4.1	
36.0	2.2					3.4	3.6				4.4	4.7	5.1			4.3	4.4	4.6				3.8	3.9	3.9	
38.0						2.4	2.5				3.4	3.7	3.9			4.0	4.2	4.5				3.6	3.7	3.8	
40.0						1.5					2.5	2.7				3.3	3.6	3.9				3.4	3.5	3.7	
42.0											1.7					2.5	2.7					3.2	3.4	3.6	
44.0																1.7	1.9					2.7	3.0	3.3	
46.0																1.1						2.0	2.2		
48.0																						1.4	1.5		
(°)	10~84	20~84	34~84	50~84	65~84	10~84	20~84	35~84	50~84	65~84	10~84	20~84	35~84	51~84	66~84	10~84	20~84	35~84	51~84	67~84	10~84	20~84	35~84	52~84	68~84
標準フック	80 t					25t					7.8t														
フック質量	1150kg					450kg					300kg														
標準巻掛本数	4					2					1														

注)カウンタウエイト47t、アウトリガ張出幅 8.3m

F B 性能

34.1mブーム+1.85m+フルオートラフィングジブ

単位：t

ジブ長さ(m)	8.5					11.6					14.7					17.8					20.9				
	オフセット					オフセット					オフセット					オフセット					オフセット				
	5°	15°	30°	45°	60°	5°	15°	30°	45°	60°	5°	15°	30°	45°	60°	5°	15°	30°	45°	60°	5°	15°	30°	45°	60°
7.0	27.5	21.5				14.6																			
8.0	25.8	20.5				14.6					13.9					13.5									
9.0	24.2	19.7	16.0			14.6	14.6				13.9					13.2									
10.0	22.8	18.8	15.6			14.6	14.6				13.9	12.8				12.8									
11.0	21.6	18.1	15.2	13.4		14.6	14.6	11.9			13.9	12.2				12.4	10.5					5.6			
12.0	20.5	17.4	14.8	13.2	12.1	14.6	14.1	11.6			13.9	11.7				12.0	10.0					5.6			
14.0	18.5	16.2	14.1	12.8	11.9	14.6	13.0	11.0	9.7		12.8	10.7	8.9			11.0	9.2					5.6	5.6		
16.0	16.9	15.1	13.5	12.5	11.8	13.9	12.1	10.4	9.4	8.6	11.5	9.9	8.4	7.4		9.9	8.5	7.1				5.6	5.6		
18.0	15.6	14.2	12.9	12.2	11.7	12.6	11.3	10.0	9.1	8.4	10.4	9.2	8.0	7.2	6.5	9.0	7.8	6.7				5.6	5.6	5.6	
20.0	14.4	13.4	12.5	12.0	11.7	11.6	10.6	9.5	8.9	8.4	9.6	8.6	7.6	6.9	6.4	8.2	7.3	6.4	5.6			5.6	5.6	5.6	
22.0	13.4	12.7	12.0	11.8		10.7	9.9	9.2	8.7	8.3	8.8	8.1	7.3	6.7	6.3	7.5	6.8	6.1	5.5	4.9		5.6	5.6	5.4	
24.0	11.8	12.0	11.7	11.6		10.0	9.4	8.8	8.5		8.1	7.6	7.0	6.6	6.2	6.9	6.4	5.8	5.3	4.8		5.6	5.6	5.1	
26.0	9.5	10.0	10.6	10.8		9.3	8.9	8.5	8.4		7.5	7.1	6.7	6.4	6.2	6.4	6.0	5.6	5.2	4.7		5.6	5.4	4.9	
28.0	7.5	8.0	8.4	8.6		8.7	8.5	8.3	8.2		7.0	6.8	6.5	6.3		5.9	5.7	5.3	5.0	4.7		5.4	5.1	4.7	
30.0	5.9	6.2	6.6			7.1	7.6	8.1	8.2		6.6	6.4	6.3	6.2		5.5	5.4	5.1	4.9			5.0	4.8	4.5	
32.0	4.5	4.8	5.0			5.7	6.1	6.6			6.2	6.1	6.1	6.1		5.2	5.1	5.0	4.8			4.7	4.5	4.3	
34.0	3.2	3.5	3.6			4.4	4.8	5.2			5.3	5.8	5.9	6.1		4.9	4.8	4.8	4.8			4.4	4.3	4.1	
36.0	2.2	2.3				3.3	3.6	3.9			4.2	4.7	5.2			4.6	4.6	4.7	4.7			4.1	4.1	4.0	
38.0	1.2	1.3				2.3	2.6				3.2	3.6	4.0			3.9	4.4	4.5				3.8	3.9	3.9	
40.0						1.5	1.6				2.3	2.6	2.9			3.1	3.5	4.0				3.6	3.7	3.8	
42.0											1.5	1.8				2.3	2.6	3.0				3.2	3.5	3.7	
44.0													1.0			1.5	1.8	2.1				2.4	2.9	3.3	
46.0																	1.1					1.8	2.1	2.5	
48.0																						1.2	1.4		
(°)	10~84	20~84	35~84	51~84	66~84	10~84	20~84	37~84	52~84	66~84	10~84	20~84	35~84	51~84	66~84	10~84	20~84	35~84	51~84	67~84	10~84	20~84	35~84	52~84	68~84
標準フック	80 t					25t					7.8t														
フック質量	1150kg					450kg					300kg														
標準巻掛本数	4					2					1														

注)カウンタウエイト47t、アウトリガ張出幅 8.3m

FB性能

46.7mブーム+1.85m+フルオートラフィングジブ

単位：t

ジブ長さ(m)	8.5					11.6					14.7					17.8					20.9					
	オフセット					オフセット					オフセット					オフセット					オフセット					
	5°	15°	30°	45°	60°	5°	15°	30°	45°	60°	5°	15°	30°	45°	60°	5°	15°	30°	45°	60°	5°	15°	30°	45°	60°	
9.0	17.5																									
10.0	17.5	17.5				14.2																				
11.0	17.5	17.5				14.2					12.0					10.1										
12.0	17.5	17.5	15.8			14.2	14.2				12.0					10.1										
14.0	16.9	16.4	15.2	13.4		14.2	14.0	11.6			12.0	11.1				10.1	9.1						5.6			
16.0	15.5	15.1	14.6	13.1	12.0	14.2	13.6	11.1	9.7		12.0	10.6	8.9			9.9	8.7						5.6			
18.0	14.3	14.0	13.7	12.8	11.9	13.4	12.8	10.7	9.5	8.5	11.5	10.2	8.5			9.4	8.3	7.0				5.6	5.6			
20.0	13.2	13.0	12.7	12.5	11.8	12.5	12.1	10.3	9.2	8.4	11.2	9.7	8.2	7.2	6.4	9.0	8.0	6.8				5.6	5.6			
22.0	12.3	12.1	11.8	11.8	11.7	11.6	11.4	9.9	9.0	8.4	10.7	9.2	7.9	7.0	6.4	8.8	7.6	6.5	5.6			5.6	5.6	5.4		
24.0	11.4	11.2	11.1	11.0		10.8	10.6	9.6	8.8	8.3	9.9	8.7	7.6	6.8	6.3	8.4	7.3	6.2	5.5	4.8		5.6	5.6	5.2		
26.0	9.9	10.5	10.3	10.3		10.1	9.9	9.3	8.7	8.3	9.2	8.2	7.3	6.7	6.2	7.8	6.9	6.0	5.4	4.8		5.6	5.6	5.1	4.5	
28.0	8.0	8.5	9.1	9.4		8.9	9.3	9.0	8.5		8.6	7.8	7.1	6.6	6.2	7.3	6.5	5.8	5.2	4.7		5.6	5.6	4.9	4.4	3.9
30.0	6.3	6.8	7.3	7.6		7.3	7.9	8.6	8.4		8.0	7.5	6.8	6.4	6.1	6.8	6.2	5.6	5.1	4.7		5.6	5.4	4.7	4.3	3.8
32.0	4.9	5.3	5.7	6.0		5.8	6.4	7.1	7.5		6.6	7.1	6.6	6.3		6.4	5.9	5.4	5.0	4.7		5.6	5.2	4.6	4.2	3.8
34.0	3.6	4.0	4.4	4.6		4.6	5.1	5.7	6.0		5.3	5.9	6.5	6.2		5.9	5.6	5.2	4.9			5.4	5.0	4.5	4.1	3.7
36.0	2.6	2.9	3.2			3.5	3.9	4.4	4.7		4.2	4.8	5.5	6.0		4.8	5.4	5.1	4.9			5.1	4.8	4.4	4.0	
38.0	1.6	1.9	2.1			2.5	2.9	3.3	3.6		3.2	3.7	4.4	4.8		3.8	4.4	4.9	4.8			4.6	4.5	4.2	3.9	
40.0		1.0	1.2			1.6	2.0	2.4			2.3	2.8	3.4	3.7		2.9	3.5	4.2	4.7			3.7	4.3	4.1	3.9	
42.0							1.2	1.5			1.5	2.0	2.5			2.1	2.7	3.3	3.7			2.9	3.6	4.0	3.8	
44.0												1.2	1.6			1.4	1.9	2.5	2.8			2.2	2.8	3.5	3.8	
46.0																	1.2	1.7				1.6	2.1	2.7	3.1	
48.0																		1.0				1.0	1.4	2.0	2.3	
50.0																									1.3	
(°)	46-84	44-84	45-84	52-84	68-84	46-84	45-84	47-84	52-84	68-84	47-84	46-84	48-84	52-84	68-84	47-84	47-84	46-84	52-84	69-84	46-84	48-84	48-84	52-84	69-84	
標準フック	25t					25t										7.8t										
フック質量	450kg					450kg										300kg										
標準巻掛本数	3					2										1										

注) カウンタウエイト47t、アウトリガ張出幅 8.3m

FB性能

50.9mブーム+1.85m+フルオートラフィングジブ

単位：t

ジブ長さ(m)	8.5					11.6					14.7					17.8					20.9					
	オフセット					オフセット					オフセット					オフセット					オフセット					
	5°	15°	30°	45°	60°	5°	15°	30°	45°	60°	5°	15°	30°	45°	60°	5°	15°	30°	45°	60°	5°	15°	30°	45°	60°	
10.0	13.8																									
11.0	13.8	13.8				11.8																				
12.0	13.8	13.8				11.8					10.1															
14.0	13.8	13.8	13.3	13.0		11.8	11.8				10.1	10.1				6.7										
16.0	13.4	13.0	12.5	12.2	12.1	11.8	11.8	11.3			10.1	10.0				6.7								5.6		
18.0	12.3	12.1	11.7	11.5	11.4	11.5	11.2	10.7	9.5		10.1	9.6	8.4			6.7	6.7						5.6	5.6		
20.0	11.4	11.2	11.0	10.8	10.8	10.9	10.5	10.1	9.3	8.5	10.0	9.5	8.2	7.3		6.7	6.7	6.7				5.6	5.6			
22.0	10.5	10.4	10.3	10.2	10.2	10.1	9.9	9.5	9.1	8.4	9.4	9.1	7.9	7.1	6.4	6.7	6.7	6.5				5.6	5.6	5.3		
24.0	9.8	9.7	9.6	9.6	9.6	9.4	9.3	9.0	8.9	8.3	9.1	8.7	7.7	6.9	6.3	6.7	6.7	6.3	5.7			5.6	5.6	5.1		
26.0	9.1	9.0	8.9	8.9		8.8	8.7	8.5	8.4	8.3	8.5	8.2	7.4	6.8	6.2	6.7	6.7	6.1	5.6	5.0		5.6	5.6	5.0	4.5	
28.0	8.4	8.4	8.3	8.3		8.2	8.1	8.0	8.0		7.9	7.8	7.2	6.6	6.2	6.7	6.7	5.9	5.5	5.0		5.6	5.5	4.8	4.4	3.9
30.0	6.7	7.2	7.7	7.8		7.5	7.6	7.5	7.5		7.4	7.3	7.0	6.5	6.1	6.7	6.5	5.7	5.3	4.9		5.6	5.3	4.7	4.3	3.8
32.0	5.3	5.7	6.2	6.5		6.1	6.6	7.1	7.1		6.8	6.9	6.8	6.4		6.6	6.3	5.6	5.2	4.9		5.6	5.2	4.5	4.2	3.8
34.0	4.1	4.4	4.8	5.1		4.8	5.3	6.0	6.3		5.5	6.2	6.4	6.3		6.2	6.1	5.4	5.1			5.6	5.0	4.4	4.1	3.8
36.0	3.0	3.3	3.7	3.8		3.7	4.2	4.7	5.1		4.4	5.0	5.7	6.1		5.2	5.8	5.3	5.0			5.4	4.8	4.3	4.0	3.7
38.0	2.0	2.3	2.6			2.7	3.2	3.6	3.9		3.4	3.9	4.6	5.0		4.2	4.8	5.2	4.9			4.8	4.7	4.2	3.9	
40.0		1.4	1.7			1.9	2.2	2.7			2.5	3.0	3.6	4.0		3.3	3.9	4.6	4.9			3.9	4.5	4.1	3.9	
42.0							1.4	1.8			1.7	2.2	2.7	3.0		2.5	3.0	3.7	4.1			3.1	3.7	4.0	3.8	
44.0												1.4	1.9			1.8	2.3	2.9	3.2			2.3	2.9	3.7	3.7	
46.0																	1.6	2.1				1.7	2.2	2.9	3.4	
48.0																		1.4				1.1	1.6	2.2	2.6	
50.0																							1.0	1.6		
(°)	50-84	48-84	49-84	54-84	69-84	50-84	49-84	50-84	54-84	69-84	50-84	50-84	52-84	54-84	69-84	51-84	50-84	50-84	54-84	69-84	49-84	49-84	49-84	52-84	54-84	69-84
標準フック	25t										7.8t															
フック質量	450kg										300kg															
標準巻掛本数	2										1															

注) カウンタウエイト47t、アウトリガ張出幅 8.3m

F B 性能

55.0mブーム+1.85m+フルオートラフィングジブ

単位：t

ジブ長さ(m)	8.5					11.6					14.7					17.8					20.9				
	オフセット					オフセット					オフセット					オフセット					オフセット				
	5°	15°	30°	45°	60°	5°	15°	30°	45°	60°	5°	15°	30°	45°	60°	5°	15°	30°	45°	60°	5°	15°	30°	45°	60°
11.0	11.5																								
12.0	11.5	11.5				10.0																			
14.0	11.5	11.5	11.4			10.0	10.0				6.9				6.7										
16.0	11.2	11.0	10.6	10.4	10.4	10.0	9.9	9.7			6.9				6.7					5.6					
18.0	10.5	10.2	9.9	9.7	9.7	9.6	9.5	9.1	8.9		6.9	6.9			6.7	6.7				5.6					
20.0	9.8	9.6	9.3	9.1	9.1	9.3	8.9	8.6	8.4	8.4	6.9	6.9	6.9		6.7	6.7				5.6	5.6				
22.0	9.2	9.0	8.7	8.6	8.6	8.7	8.4	8.1	8.0	8.0	6.9	6.9	6.9	6.9	6.7	6.7	6.3			5.6	5.6				
24.0	8.5	8.4	8.2	8.1	8.1	8.1	7.9	7.6	7.5	7.5	6.9	6.9	6.9	6.9	6.4	6.7	6.7	6.1	5.6	5.6	5.6	5.0			
26.0	7.9	7.8	7.7	7.6	7.6	7.6	7.4	7.2	7.1	7.1	6.9	6.9	6.7	6.6	6.3	6.6	6.5	5.9	5.5	5.1	5.6	5.6	4.8		
28.0	7.3	7.3	7.2	7.2		7.1	7.0	6.8	6.7	6.7	6.7	6.5	6.3	6.2	6.2	6.4	6.2	5.8	5.4	5.0	5.6	5.4	4.7	4.3	
30.0	6.8	6.8	6.7	6.7		6.6	6.6	6.4	6.4		6.3	6.2	6.0	5.9	5.9	6.0	5.9	5.6	5.2	4.9	5.5	5.2	4.6	3.9	
32.0	5.6	6.0	6.3	6.3		6.2	6.2	6.1	6.1		6.0	5.8	5.7	5.6	5.6	5.7	5.5	5.4	5.1	4.9	5.3	5.0	4.4	3.8	
34.0	4.3	4.7	5.1	5.4		5.0	5.5	5.8	5.7		5.6	5.5	5.4	5.3		5.4	5.3	5.1	5.0	4.9	5.2	4.9	4.3	4.0	
36.0	3.2	3.6	4.0	4.2		3.9	4.4	5.0	5.3		4.8	5.2	5.1	5.1		5.1	5.0	4.9	4.8		4.9	4.7	4.2	4.0	
38.0	2.3	2.6	2.9	3.1		2.9	3.4	3.9	4.2		3.8	4.3	4.9	4.8		4.3	4.8	4.6	4.6		4.7	4.5	4.1	3.9	
40.0		1.7	2.0			2.1	2.5	2.9	3.2		2.9	3.4	4.0	4.4		3.4	4.0	4.4	4.4		4.0	4.3	4.0	3.8	
42.0							1.7	2.1			2.1	2.6	3.1	3.5		2.6	3.2	3.9	4.2		3.2	3.8	3.9	3.7	
44.0											1.4	1.8	2.3	2.6		1.9	2.4	3.1	3.5		2.4	3.1	3.8	3.7	
46.0													1.6				1.7	2.3	2.6		1.8	2.4	3.1	3.6	
48.0																		1.6				1.7	2.4	2.8	
50.0																						1.7	2.1		
(°)	53~84	52~84	53~84	55~84	69~84	53~84	52~84	54~84	55~84	69~84	51~84	53~84	53~84	55~84	69~84	53~84	53~84	53~84	55~84	69~84	53~84	54~84	54~84	55~84	69~84
標準フック	25t										7.8t														
フック質量	450kg										300kg														
標準巻掛本数	2										1														

注)カウンタウエイト47t、アウトリガ張出幅 8.3m

F B 性能

59.2mブーム+1.85m+フルオートラフィングジブ

単位：t

ジブ長さ(m)	8.5					11.6					14.7					17.8					20.9				
	オフセット					オフセット					オフセット					オフセット					オフセット				
	5°	15°	30°	45°	60°	5°	15°	30°	45°	60°	5°	15°	30°	45°	60°	5°	15°	30°	45°	60°	5°	15°	30°	45°	60°
11.0	9.6																								
12.0	9.6	9.4				7.5																			
14.0	9.0	8.7	8.3			7.5	7.5				6.5				5.7										
16.0	8.4	8.3	7.7	7.5		7.5	7.4				6.5	6.5			5.7					5.0					
18.0	8.1	7.8	7.3	7.1	7.0	7.2	6.9	6.5			6.5	6.3			5.7	5.7				5.0					
20.0	7.5	7.3	6.9	6.7	6.6	7.0	6.5	6.1	5.9		6.3	6.0	5.5		5.7	5.5				5.0	5.0				
22.0	7.1	6.8	6.6	6.3	6.3	6.5	6.2	5.8	5.6	5.5	5.9	5.6	5.2	5.0	5.5	5.2	4.8			5.0	4.8				
24.0	6.6	6.4	6.2	6.0	6.0	6.1	5.9	5.5	5.3	5.3	5.7	5.3	5.0	4.8	4.7	5.2	4.9	4.6		4.8	4.5	4.2			
26.0	6.2	6.0	5.8	5.7	5.7	5.8	5.6	5.2	5.0	5.0	5.4	5.1	4.8	4.6	4.5	5.0	4.7	4.4	4.2	4.6	4.3	4.0			
28.0	5.9	5.7	5.5	5.4		5.4	5.2	5.0	4.8	4.8	5.1	4.8	4.5	4.4	4.3	4.8	4.4	4.2	4.0	3.9	4.3	4.1	3.8	3.6	
30.0	5.5	5.4	5.2	5.1		5.1	5.0	4.8	4.6		4.8	4.6	4.3	4.2	4.2	4.5	4.2	4.0	3.8	3.8	4.2	3.9	3.6	3.5	
32.0	5.2	5.1	4.9	4.9		4.9	4.7	4.5	4.4		4.5	4.4	4.1	4.0	4.0	4.3	4.0	3.8	3.7	3.6	4.0	3.7	3.5	3.3	
34.0	4.7	4.8	4.7	4.6		4.6	4.4	4.3	4.2		4.3	4.1	3.9	3.8		4.1	3.9	3.6	3.5	3.5	3.8	3.5	3.3	3.2	
36.0	3.6	3.9	4.3	4.4		4.3	4.2	4.1	4.0		4.1	3.9	3.8	3.7		3.8	3.7	3.4	3.3		3.6	3.4	3.2	3.1	
38.0	2.6	2.9	3.3	3.5		3.5	3.9	3.9	3.8		3.9	3.7	3.6	3.5		3.6	3.5	3.3	3.2		3.4	3.2	3.0	3.0	
40.0		2.0	2.3			2.6	3.0	3.5	3.7		3.1	3.5	3.4	3.4		3.5	3.3	3.2	3.1		3.3	3.1	2.9	2.8	
42.0						1.8	2.2	2.6	2.8		2.3	2.8	3.3	3.2		2.8	3.2	3.1	3.0		3.1	3.0	2.8	2.7	
44.0								1.8			1.6	2.1	2.6	2.9		2.1	2.6	2.9	2.9		2.6	2.8	2.7	2.6	
46.0													1.9				1.9	2.5	2.8		2.0	2.5	2.6	2.5	
48.0																		1.9	2.2			1.9	2.5	2.4	
50.0																						1.9	2.4		
(°)	55~84	54~84	55~84	57~84	70~84	54~84	55~84	54~84	57~84	70~84	54~84	55~84	55~84	57~84	70~84	55~84	56~84	56~84	57~84	70~84	56~84	56~84	57~84	70~84	
標準フック	25t										7.8t														
フック質量	450kg										300kg														
標準巻掛本数	2										1														

注)カウンタウエイト47t、アウトリガ張出幅 8.3m

FB性能

63.4mブーム+1.85m+フルオートラフィングジブ

単位：t

ジブ長さ(m) 作業半径(m)	8.5					11.6					14.7					17.8					20.9				
	オフセット					オフセット					オフセット					オフセット					オフセット				
	5°	15°	30°	45°	60°	5°	15°	30°	45°	60°	5°	15°	30°	45°	60°	5°	15°	30°	45°	60°	5°	15°	30°	45°	60°
14.0	7.0	7.0				6.1					5.4														
16.0	6.8	6.6	6.3			6.1	6.0				5.4					4.7									
18.0	6.3	6.1	5.9	5.7		5.9	5.7	5.3			5.4	5.2				4.7					4.2				
20.0	6.0	5.8	5.5	5.3	5.3	5.5	5.3	5.0	4.8		5.2	4.9				4.7	4.5				4.2				
22.0	5.6	5.4	5.1	5.0	5.0	5.2	5.0	4.7	4.5	4.5	4.8	4.6	4.3			4.6	4.3				4.2	4.0			
24.0	5.3	5.1	4.8	4.7	4.7	4.9	4.7	4.4	4.3	4.2	4.5	4.3	4.1	3.9		4.3	4.0	3.8			4.0	3.7			
26.0	4.9	4.8	4.6	4.4	4.4	4.6	4.4	4.2	4.1	4.0	4.3	4.1	3.9	3.7	3.7	4.0	3.8	3.6			3.8	3.5	3.3		
28.0	4.6	4.5	4.3	4.2	4.2	4.3	4.1	3.9	3.9	3.8	4.0	3.8	3.6	3.5	3.5	3.8	3.6	3.4	3.3	3.2	3.6	3.4	3.1		
30.0	4.3	4.2	4.1	4.0		4.1	3.9	3.7	3.6	3.6	3.8	3.6	3.5	3.3	3.3	3.6	3.4	3.2	3.1	3.1	3.3	3.2	3.0	2.9	
32.0	4.0	4.0	3.9	3.8		3.8	3.7	3.5	3.4		3.6	3.4	3.3	3.2	3.2	3.4	3.2	3.0	2.9	2.9	3.2	3.0	2.8	2.7	
34.0	3.8	3.7	3.6	3.6		3.6	3.5	3.3	3.3		3.4	3.2	3.1	3.0	3.0	3.2	3.0	2.9	2.8	2.8	3.0	2.9	2.7	2.6	
36.0	3.6	3.5	3.4	3.4		3.4	3.3	3.2	3.1		3.2	3.1	2.9	2.8		3.0	2.9	2.7	2.7	2.6	2.8	2.7	2.6	2.5	
38.0	3.1	3.3	3.2	3.2		3.2	3.1	3.0	2.9		3.0	2.9	2.8	2.7		2.9	2.7	2.6	2.5		2.7	2.5	2.4	2.3	
40.0	2.3	2.6	2.9	3.0		2.8	2.9	2.8	2.8		2.8	2.8	2.6	2.6		2.7	2.6	2.4	2.4		2.5	2.4	2.3	2.2	
42.0		1.7	2.0			2.1	2.4	2.7	2.6		2.6	2.6	2.5	2.4		2.5	2.4	2.3	2.3		2.4	2.3	2.2	2.1	
44.0								2.1	2.3		1.9	2.3	2.4	2.3		2.3	2.3	2.2	2.1		2.3	2.2	2.0	2.0	
46.0													2.1	2.2			2.1	2.1	2.0		2.1	2.1	1.9	1.9	
48.0																		2.0	2.0			2.0	1.8	1.8	
50.0																			1.8				1.8	1.7	
(°)	56-84	55-84	56-84	57-84	70-84	56-84	57-84	57-84	57-84	70-84	56-84	58-84	58-84	57-84	70-84	57-84	58-84	58-84	57-84	70-84	58-84	58-84	59-84	61-84	
標準フック	7.8t																								
フック質量	300kg																								
標準巻掛本数	1																								

注) カウンタウエイト47t、アウトリガ張出幅 8.3m

FC性能

30.0mブーム+1.85m+フルオートラフィングジブ

単位：t

ジブ長さ(m) 作業半径(m)	8.5					11.6					14.7					17.8					20.9				
	オフセット					オフセット					オフセット					オフセット					オフセット				
	5°	15°	30°	45°	60°	5°	15°	30°	45°	60°	5°	15°	30°	45°	60°	5°	15°	30°	45°	60°	5°	15°	30°	45°	60°
7.0	26.1	20.9				14.6					13.9														
8.0	24.4	19.9				14.6	14.6				13.9					13.5									
9.0	22.8	19.0	15.8			14.6	14.6				13.9					13.4					5.6				
10.0	21.5	18.2	15.3	13.6		14.6	14.5				13.9	12.4				13.0					5.6				
11.0	20.3	17.4	14.9	13.3	12.2	14.6	13.8	11.5			13.9	11.8				12.5	10.2				5.6				
12.0	19.2	16.7	14.5	13.1	12.1	14.6	13.2	11.2			13.4	11.3				11.7	9.8				5.6				
14.0	17.3	15.5	13.8	12.7	11.9	13.9	12.2	10.6	9.5	8.6	12.0	10.3	8.8			10.4	8.9				5.6	5.6			
16.0	15.8	14.4	13.2	12.4	11.8	12.6	11.3	10.0	9.2	8.5	10.8	9.5	8.3	7.4		9.3	8.2	7.0			5.6	5.6			
18.0	14.5	13.5	12.6	12.1	11.7	11.5	10.5	9.6	8.9	8.4	9.8	8.8	7.8	7.1	6.5	8.4	7.6	6.6	5.8		5.6	5.6	5.6		
20.0	13.4	12.7	12.1	11.9		10.5	9.8	9.1	8.7	8.3	8.9	8.2	7.5	6.9	6.4	7.7	7.0	6.3	5.6	5.0	5.6	5.6	5.6		
22.0	10.7	11.3	11.7	11.7		9.7	9.2	8.8	8.5	8.3	8.2	7.7	7.1	6.7	6.3	7.0	6.5	6.0	5.4	4.9	5.6	5.6	5.3	4.6	
24.0	8.3	8.8	9.4	9.7		9.0	8.7	8.4	8.3		7.6	7.2	6.8	6.5	6.3	6.5	6.1	5.7	5.3	4.8	5.6	5.5	5.0	4.5	4.0
26.0	6.3	6.7	7.2	7.4		7.6	8.3	8.2	8.2		7.0	6.8	6.6	6.4		6.0	5.7	5.4	5.1	4.8	5.4	5.2	4.8	4.3	3.9
28.0	4.6	5.0	5.3			5.9	6.5	7.1	7.4		6.5	6.4	6.3	6.3		5.5	5.4	5.2	5.0		5.0	4.8	4.6	4.2	3.9
30.0	3.2	3.5	3.7			4.5	4.9	5.4			5.5	6.1	6.1	6.2		5.2	5.1	5.0	4.9		4.7	4.6	4.4	4.1	3.8
32.0	2.0	2.2	2.3			3.2	3.6	3.9			4.2	4.7	5.4			4.8	4.8	4.9	4.8		4.3	4.3	4.2	4.0	
34.0		1.0				2.1	2.4	2.6			3.1	3.5	4.0			3.9	4.5	4.7	4.8		4.1	4.1	4.1	3.9	
36.0						1.1	1.3				2.1	2.5	2.9			2.9	3.4	4.0			3.8	3.9	3.9	3.8	
38.0											1.2	1.5	1.8			2.0	2.5	2.9			3.0	3.6	3.8		
40.0																1.3	1.6	1.9			2.2	2.7	3.3		
42.0																					1.5	1.9	2.3		
44.0																						1.2	1.5		
(°)	33-84	28-84	34-84	50-84	65-84	10-84	20-84	35-84	50-84	65-84	10-84	20-84	35-84	51-84	66-84	10-84	20-84	35-84	51-84	67-84	10-84	20-84	35-84	52-84	68-84
標準フック	80t					25t										7.8t									
フック質量	1150kg					450kg										300kg									
標準巻掛本数	4					2										1									

注) カウンタウエイト35t、アウトリガ張出幅 8.3m

FC性能

34.1mブーム+1.85m+フルオートラフィングジブ

単位：t

ジブ長さ(m) 作業半径(m)	8.5					11.6					14.7					17.8					20.9				
	オフセット					オフセット					オフセット					オフセット					オフセット				
	5°	15°	30°	45°	60°	5°	15°	30°	45°	60°	5°	15°	30°	45°	60°	5°	15°	30°	45°	60°	5°	15°	30°	45°	60°
7.0	27.5	21.5				14.6																			
8.0	25.8	20.5				14.6					13.9					13.5									
9.0	24.2	19.7	16.0			14.6	14.6				13.9					13.2									
10.0	22.8	18.8	15.6			14.6	14.6				13.9	12.8				12.8									
11.0	21.6	18.1	15.2	13.4		14.6	14.6	11.9			13.9	12.2				12.4	10.5				5.6				
12.0	20.5	17.4	14.8	13.2	12.1	14.6	14.1	11.6			13.9	11.7				12.0	10.0				5.6				
14.0	18.5	16.2	14.1	12.8	11.9	14.6	13.0	11.0	9.7		12.8	10.7	8.9			11.0	9.2				5.6	5.6			
16.0	16.9	15.1	13.5	12.5	11.8	13.9	12.1	10.4	9.4	8.6	11.5	9.9	8.4	7.4		9.9	8.5	7.1			5.6	5.6			
18.0	15.6	14.2	12.9	12.2	11.7	12.6	11.3	10.0	9.1	8.4	10.4	9.2	8.0	7.2	6.5	9.0	7.8	6.7			5.6	5.6	5.6		
20.0	13.4	13.4	12.5	12.0	11.7	11.6	10.6	9.5	8.9	8.4	9.6	8.6	7.6	6.9	6.4	8.2	7.3	6.4	5.6		5.6	5.6	5.6		
22.0	10.7	11.3	12.0	11.8		10.7	9.9	9.2	8.7	8.3	8.8	8.1	7.3	6.7	6.3	7.5	6.8	6.1	5.5	4.9	5.6	5.6	5.4	4.6	
24.0	8.3	8.8	9.5	9.9		9.6	9.4	8.8	8.5		8.1	7.6	7.0	6.6	6.2	6.9	6.4	5.8	5.3	4.8	5.6	5.6	5.1	4.5	3.9
26.0	6.2	6.7	7.3	7.6		7.5	8.2	8.5	8.4		7.5	7.1	6.7	6.4	6.2	6.4	6.0	5.6	5.2	4.7	5.6	5.4	4.9	4.3	3.9
28.0	4.6	5.0	5.4	5.6		5.8	6.4	7.2	7.6		6.8	6.8	6.5	6.3		5.9	5.7	5.3	5.0	4.7	5.4	5.1	4.7	4.2	3.8
30.0	3.1	3.5	3.8			4.4	4.9	5.5	5.8		5.3	6.0	6.3	6.2		5.5	5.4	5.1	4.9		5.0	4.8	4.5	4.1	3.8
32.0	1.9	2.2	2.5			3.1	3.6	4.1			4.0	4.6	5.4	5.8		4.8	5.1	5.0	4.8		4.7	4.5	4.3	4.0	
34.0						2.0	2.4	2.8			2.9	3.5	4.1	4.4		3.7	4.3	4.8	4.8		4.4	4.3	4.1	3.9	
36.0						1.0	1.4	1.7			2.0	2.4	2.9			2.7	3.3	4.0	4.4		3.6	4.1	4.0	3.8	
38.0											1.1	1.5	1.9			1.8	2.3	2.9			2.8	3.4	3.9	3.8	
40.0																1.0	1.5	2.0			2.0	2.5	3.2	3.7	
42.0																		1.1			1.3	1.8	2.4		
44.0																						1.0	1.5		
(°)	41-84	42-84	43-84	51-84	66-84	38-84	39-84	37-84	52-84	66-84	39-84	41-84	43-84	51-84	66-84	40-84	42-84	41-84	51-84	67-84	41-84	41-84	44-84	52-84	68-84
標準フック	80t					25t										7.8t									
フック質量	1150kg					450kg										300kg									
標準巻掛本数	4					2										1									

注) カウンタウエイト35t、アウトリガ張出幅 8.3m

FC性能

38.3mブーム+1.85m+フルオートラフィングジブ

単位：t

ジブ長さ(m) 作業半径(m)	8.5					11.6					14.7					17.8					20.9					
	オフセット					オフセット					オフセット					オフセット					オフセット					
	5°	15°	30°	45°	60°	5°	15°	30°	45°	60°	5°	15°	30°	45°	60°	5°	15°	30°	45°	60°	5°	15°	30°	45°	60°	
7.0	25.0																									
8.0	25.0	21.6				14.6																				
9.0	25.0	20.7				14.6					13.9					12.9										
10.0	24.7	19.9	16.1			14.6	14.6				13.9					12.6										
11.0	23.4	19.1	15.7			14.6	14.6				13.9	12.6				12.2						5.6				
12.0	22.2	18.4	15.3	13.5	12.2	14.6	14.6	11.8			13.9	12.1				11.8	10.1					5.6				
14.0	20.2	17.2	14.6	13.1	12.1	14.6	13.6	11.2	9.8		13.6	11.1	9.1			11.1	9.5					5.6				
16.0	18.4	16.1	14.0	12.8	11.9	14.6	12.6	10.7	9.5	8.6	12.3	10.3	8.6			10.6	8.8	7.2				5.6	5.6			
18.0	16.9	15.1	13.5	12.5	11.8	13.5	11.8	10.2	9.2	8.5	11.2	9.6	8.2	7.3		9.6	8.2	6.9				5.6	5.6			
20.0	13.5	14.2	13.0	12.2	11.8	12.5	11.1	9.8	9.0	8.4	10.2	9.0	7.8	7.0	6.4	8.8	7.6	6.5	5.7			5.6	5.6	5.6		
22.0	10.8	11.4	12.1	12.0		11.5	10.5	9.4	8.8	8.3	9.4	8.5	7.5	6.8	6.3	8.0	7.1	6.2	5.5	4.9		5.6	5.6	5.5		
24.0	8.3	8.9	9.7	10.1		9.5	9.9	9.1	8.6	8.3	8.7	8.0	7.2	6.7	6.2	7.4	6.7	6.0	5.4	4.8		5.6	5.6	5.3	4.5	
26.0	6.3	6.8	7.5	7.8		7.4	8.2	8.8	8.5		8.1	7.5	6.9	6.5	6.2	6.9	6.3	5.7	5.2	4.8		5.6	5.6	5.0	4.4	3.9
28.0	4.6	5.1	5.6	5.9		5.7	6.4	7.2	7.7		6.6	7.1	6.7	6.4		6.4	6.0	5.5	5.1	4.7		5.6	5.3	4.8	4.3	3.8
30.0	3.2	3.6	4.0	4.2		4.3	4.8	5.5	5.9		5.1	5.9	6.5	6.3		5.9	5.7	5.3	5.0			5.4	5.0	4.6	4.2	3.8
32.0	2.0	2.3	2.6			3.0	3.5	4.1	4.4		3.9	4.5	5.4	5.9		4.6	5.4	5.1	4.9			5.0	4.8	4.4	4.1	3.8
34.0		1.2	1.4			1.9	2.4	2.9	3.1		2.8	3.4	4.1	4.5		3.5	4.2	5.0	4.8			4.4	4.5	4.3	4.0	
36.0							1.3	1.7			1.8	2.3	2.9	3.3		2.5	3.2	4.0	4.5			3.4	4.2	4.1	3.9	
38.0												1.4	1.9			1.6	2.2	2.9	3.3			2.5	3.3	4.0	3.8	
40.0																	1.4	2.0				1.8	2.4	3.2	3.7	
42.0																		1.1				1.0	1.6	2.3	2.7	
44.0																									1.5	
(°)	46-84	44-84	45-84	51-84	67-84	47-84	45-84	47-84	51-84	67-84	47-84	46-84	49-84	51-84	67-84	47-84	47-84	52-84	68-84	46-84	49-84	49-84	52-84	68-84	68-84	
標準フック	80 t					25 t					7.8 t															
フック質量	1150kg					450kg					300kg															
標準巻掛本数	4					2					1															

注) カウンタウエイト35t、アウトリガ張出幅 8.3m

FC性能

42.5mブーム+1.85m+フルオートラフィングジブ

単位：t

ジブ長さ(m) 作業半径(m)	8.5					11.6					14.7					17.8					20.9						
	オフセット					オフセット					オフセット					オフセット					オフセット						
	5°	15°	30°	45°	60°	5°	15°	30°	45°	60°	5°	15°	30°	45°	60°	5°	15°	30°	45°	60°	5°	15°	30°	45°	60°		
8.0	21.3																										
9.0	21.3	21.3				14.6																					
10.0	21.3	20.5				14.6					13.9					11.5											
11.0	21.3	19.7	15.9			14.6	14.6				13.9					11.5											
12.0	21.0	19.0	15.6	13.6		14.6	14.6				13.8	12.0				11.5						5.6					
14.0	19.5	17.8	14.9	13.3	12.1	14.6	14.1	11.4			13.1	11.4				10.8	9.4					5.6					
16.0	18.1	16.7	14.3	12.9	12.0	14.6	13.1	10.9	9.6	8.6	12.4	10.7	8.8			10.2	8.9					5.6	5.6				
18.0	16.7	15.8	13.8	12.6	11.8	14.4	12.3	10.5	9.4	8.5	11.9	10.0	8.4	7.3		9.8	8.5	7.0				5.6	5.6				
20.0	13.7	14.4	13.3	12.4	11.8	13.3	11.6	10.1	9.1	8.4	10.9	9.4	8.0	7.1	6.4	9.3	7.9	6.7	5.8			5.6	5.6	5.6			
22.0	11.0	11.6	12.3	12.2	11.7	11.9	10.9	9.7	8.9	8.3	10.1	8.8	7.7	6.9	6.3	8.6	7.4	6.4	5.6	4.9		5.6	5.6	5.5			
24.0	8.5	9.2	9.9	10.4		9.6	10.4	9.4	8.7	8.3	9.3	8.3	7.4	6.8	6.3	7.9	7.0	6.1	5.4	4.8		5.6	5.6	5.3	4.6		
26.0	6.5	7.1	7.7	8.1		7.6	8.3	9.1	8.6	8.2	8.4	7.9	7.1	6.6	6.2	7.3	6.6	5.9	5.3	4.8		5.6	5.6	5.1	4.4	3.9	
28.0	4.8	5.3	5.9	6.2		5.9	6.5	7.4	8.0		6.7	7.5	6.9	6.5	6.2	6.8	6.3	5.7	5.2	4.7		5.6	5.6	4.9	4.3	3.9	
30.0	3.4	3.8	4.3	4.6		4.4	5.0	5.7	6.2		5.2	6.0	6.7	6.4		5.9	5.9	5.5	5.1	4.7		5.6	5.3	4.8	4.2	3.8	
32.0	2.2	2.5	2.9	3.1		3.1	3.7	4.3	4.7		3.9	4.6	5.5	6.1		4.6	5.5	5.3	5.0			5.4	5.0	4.6	4.1	3.8	
34.0			1.8			2.1	2.5	3.1	3.4		2.8	3.5	4.2	4.7		3.5	4.3	5.1	4.9			4.4	4.8	4.4	4.0	3.7	
36.0								2.0	2.2		1.9	2.4	3.1	3.5		2.5	3.2	4.1	4.7			3.4	4.2	4.3	4.0		
38.0													2.1	2.4		1.7	2.3	3.0	3.5			2.5	3.3	4.1	3.9		
40.0																	2.1	2.5				1.8	2.4	3.3	3.8		
42.0																		1.6					1.7	2.4	2.9		
44.0																									1.6	2.1	
(°)	51-84	52-84	50-84	51-84	67-84	51-84	53-84	52-84	51-84	67-84	51-84	53-84	53-84	51-84	67-84	51-84	53-84	54-84	52-84	68-84	52-84	52-84	53-84	52-84	68-84	68-84	
標準フック	25 t					25 t					7.8 t																
フック質量	450kg					450kg					300kg																
標準巻掛本数	3					2					1																

注) カウンタウエイト35t、アウトリガ張出幅 8.3m

FC性能

46.7mブーム+1.85m+フルオートラフィングジブ

単位：t

ジブ長さ(m)	8.5					11.6					14.7					17.8					20.9						
	オフセット					オフセット					オフセット					オフセット					オフセット						
	5°	15°	30°	45°	60°	5°	15°	30°	45°	60°	5°	15°	30°	45°	60°	5°	15°	30°	45°	60°	5°	15°	30°	45°	60°		
9.0	17.5																										
10.0	17.5	17.5				14.2																					
11.0	17.5	17.5				14.2					12.0					10.1											
12.0	17.5	17.5	15.8			14.2	14.2				12.0					10.1											
14.0	16.9	16.4	15.2	13.4		14.2	14.0	11.6			12.0	11.1				10.1	9.1							5.6			
16.0	15.5	15.1	14.6	13.1	12.0	14.2	13.6	11.1	9.7		12.0	10.6	8.9			9.9	8.7							5.6			
18.0	14.3	14.0	13.7	12.8	11.9	13.4	12.8	10.7	9.5	8.5	11.5	10.2	8.5			9.4	8.3	7.0					5.6	5.6			
20.0	13.2	13.0	12.7	12.5	11.8	12.5	12.1	10.3	9.2	8.4	11.2	9.7	8.2	7.2	6.4	9.0	8.0	6.8					5.6	5.6			
22.0	11.1	11.7	11.8	11.8	11.7	11.6	11.4	9.9	9.0	8.4	10.7	9.2	7.9	7.0	6.4	8.8	7.6	6.5	5.6				5.6	5.6	5.4		
24.0	8.7	9.3	10.1	10.6		9.7	10.5	9.6	8.8	8.3	9.9	8.7	7.6	6.8	6.3	8.4	7.3	6.2	5.5	4.8			5.6	5.6	5.2		
26.0	6.7	7.2	7.9	8.4		7.7	8.5	9.3	8.7	8.3	8.5	8.2	7.3	6.7	6.2	7.8	6.9	6.0	5.4	4.8			5.6	5.6	5.1	4.5	
28.0	5.0	5.5	6.1	6.5		6.0	6.7	7.6	8.2		6.7	7.6	7.1	6.6	6.2	7.3	6.5	5.8	5.2	4.7			5.6	5.6	4.9	4.4	3.9
30.0	3.6	4.0	4.5	4.8		4.5	5.1	5.9	6.4		5.3	6.1	6.8	6.4	6.1	5.9	6.2	5.6	5.1	4.7			5.6	5.4	4.7	4.3	3.8
32.0	2.3	2.7	3.2	3.4		3.3	3.8	4.5	4.9		4.0	4.7	5.6	6.3		4.6	5.5	5.4	5.0	4.7			5.5	5.2	4.6	4.2	3.8
34.0				2.2		2.2	2.7	3.3	3.6		2.9	3.6	4.4	4.9		3.5	4.3	5.2	4.9				4.4	5.0	4.5	4.1	3.7
36.0								2.2	2.5			2.5	3.2	3.7		2.5	3.3	4.2	4.8				3.4	4.3	4.4	4.0	
38.0													2.3	2.6			2.3	3.1	3.7				2.5	3.3	4.2	3.9	
40.0																		2.2	2.7				1.7	2.5	3.4	3.9	
42.0																			1.8					1.7	2.5	3.1	
44.0																									1.7	2.2	
46.0																											1.4
(°)	54-84	55-84	57-84	54-84	68-84	54-84	56-84	55-84	56-84	68-84	56-84	56-84	56-84	57-84	68-84	56-84	56-84	57-84	56-84	69-84	54-84	55-84	56-84	55-84	69-84		
標準フック	25t					25t										7.8t											
フック質量	450kg					450kg										300kg											
標準巻掛本数	3					2										1											

注) カウンタウエイト35t、アウトリガ張幅 8.3m

FC性能

50.9mブーム+1.85m+フルオートラフィングジブ

単位：t

ジブ長さ(m)	8.5					11.6					14.7					17.8					20.9						
	オフセット					オフセット					オフセット					オフセット					オフセット						
	5°	15°	30°	45°	60°	5°	15°	30°	45°	60°	5°	15°	30°	45°	60°	5°	15°	30°	45°	60°	5°	15°	30°	45°	60°		
10.0	13.8																										
11.0	13.8	13.8				11.8																					
12.0	13.8	13.8				11.8					10.1																
14.0	13.8	13.8	13.3	13.0		11.8	11.8				10.1	10.1				6.7											
16.0	13.4	13.0	12.5	12.2	12.1	11.8	11.8	11.3			10.1	10.0				6.7								5.6			
18.0	12.3	12.1	11.7	11.5	11.4	11.5	11.2	10.7	9.5		10.1	9.6	8.4			6.7	6.7						5.6	5.6			
20.0	11.4	11.2	11.0	10.8	10.8	10.9	10.5	10.1	9.3	8.5	10.0	9.5	8.2	7.3		6.7	6.7	6.7					5.6	5.6			
22.0	10.5	10.4	10.3	10.2	10.2	10.1	9.9	9.5	9.1	8.4	9.4	9.1	7.9	7.1	6.4	6.7	6.7	6.5					5.6	5.6	5.3		
24.0	9.1	9.7	9.6	9.6	9.6	9.4	9.3	9.0	8.9	8.3	9.1	8.7	7.7	6.9	6.3	6.7	6.7	6.3	5.7				5.6	5.6	5.1		
26.0	7.1	7.7	8.4	8.9		7.9	8.7	8.5	8.4	8.3	8.5	8.2	7.4	6.8	6.2	6.7	6.7	6.1	5.6	5.0			5.6	5.6	5.0	4.5	
28.0	5.4	5.9	6.5	6.9		6.2	6.9	7.8	8.0		6.9	7.8	7.2	6.6	6.2	6.7	6.7	5.9	5.5	5.0			5.6	5.5	4.8	4.4	3.9
30.0	4.0	4.4	5.0	5.3		4.8	5.4	6.2	6.7		5.5	6.3	7.0	6.5	6.1	6.3	6.5	5.7	5.3	4.9			5.6	5.3	4.7	4.3	3.8
32.0	2.7	3.1	3.6	3.9		3.5	4.1	4.8	5.3		4.2	4.9	5.9	6.4		5.0	5.9	5.6	5.2	4.9			5.6	5.2	4.5	4.2	3.8
34.0			2.4	2.7			2.9	3.6	4.0		3.1	3.8	4.6	5.2		3.9	4.7	5.4	5.1				4.5	5.0	4.4	4.1	3.8
36.0								2.5	2.8			2.7	3.5	4.0		2.9	3.6	4.6	5.0				3.5	4.4	4.3	4.0	3.7
38.0													2.5	2.9			2.7	3.6	4.1				2.6	3.4	4.2	3.9	
40.0																		2.6	3.2					2.6	3.5	3.9	
42.0																			2.3						2.7	3.3	
44.0																									1.9	2.4	
46.0																											1.7
(°)	57-84	58-84	57-84	58-84	69-84	59-84	58-84	58-84	59-84	69-84	59-84	59-84	59-84	60-84	69-84	59-84	59-84	60-84	59-84	69-84	59-84	59-84	58-84	58-84	69-84		
標準フック	25t										7.8t																
フック質量	450kg										300kg																
標準巻掛本数	2										1																

注) カウンタウエイト35t、アウトリガ張幅 8.3m

F C 性能

55.0mブーム+1.85m+フルオートラフィングジブ

単位：t

ジブ長さ(m)	8.5					11.6					14.7					17.8					20.9				
	オフセット					オフセット					オフセット					オフセット					オフセット				
	5°	15°	30°	45°	60°	5°	15°	30°	45°	60°	5°	15°	30°	45°	60°	5°	15°	30°	45°	60°	5°	15°	30°	45°	60°
11.0	11.5																								
12.0	11.5	11.5				10.0																			
14.0	11.5	11.5	11.4			10.0	10.0				6.9					6.7									
16.0	11.2	11.0	10.6	10.4	10.4	10.0	9.9	9.7			6.9					6.7					5.6				
18.0	10.5	10.2	9.9	9.7	9.7	9.6	9.5	9.1	8.9		6.9	6.9				6.7	6.7				5.6				
20.0	9.8	9.6	9.3	9.1	9.1	9.3	8.9	8.6	8.4	8.4	6.9	6.9	6.9			6.7	6.7				5.6	5.6			
22.0	9.2	9.0	8.7	8.6	8.6	8.7	8.4	8.1	8.0	8.0	6.9	6.9	6.9	6.9		6.7	6.7	6.3			5.6	5.6			
24.0	8.5	8.4	8.2	8.1	8.1	8.1	7.9	7.6	7.5	7.5	6.9	6.9	6.9	6.9	6.4	6.7	6.7	6.1	5.6		5.6	5.6	5.0		
26.0	7.4	7.8	7.7	7.6	7.6	7.6	7.4	7.2	7.1	7.1	6.9	6.9	6.7	6.6	6.3	6.6	6.5	5.9	5.5	5.1	5.6	5.6	4.8		
28.0	5.7	6.2	6.8	7.2		6.4	7.0	6.8	6.7	6.7	6.7	6.5	6.3	6.2	6.2	6.4	6.2	5.8	5.4	5.0	5.6	5.4	4.7	4.3	
30.0	4.2	4.7	5.3	5.6		5.0	5.6	6.4	6.4		5.9	6.2	6.0	5.9	5.9	6.0	5.9	5.6	5.2	4.9	5.5	5.2	4.6	4.2	3.9
32.0	3.0	3.4	3.9	4.2		3.7	4.3	5.0	5.5		4.6	5.3	5.7	5.6	5.6	5.2	5.5	5.4	5.1	4.9	5.3	5.0	4.4	4.1	3.8
34.0			2.7	3.0			3.1	3.8	4.2		3.5	4.2	5.0	5.3		4.0	4.8	5.1	5.0	4.9	4.6	4.9	4.3	4.0	3.8
36.0								2.7	3.1		2.5	3.1	3.9	4.4		3.1	3.8	4.7	4.8		3.6	4.5	4.2	4.0	3.7
38.0													2.9	3.4			2.9	3.7	4.3		2.7	3.5	4.1	3.9	3.7
40.0														2.4				2.8	3.4			2.7	3.7	3.8	
42.0																			2.5				2.8	3.5	
44.0																							2.1	2.6	
(°)	59-84	60-84	59-84	60-84	69-84	61-84	61-84	60-84	61-84	69-84	59-84	61-84	61-84	60-84	69-84	61-84	61-84	62-84	61-84	69-84	61-84	61-84	60-84	62-84	69-84
標準フック	25t										7.8t														
フック質量	450kg										300kg														
標準巻掛本数	2										1														

注) カウンタウエイト35t、アウトリガ張出幅 8.3m

F C 性能

59.2mブーム+1.85m+フルオートラフィングジブ

単位：t

ジブ長さ(m)	8.5					11.6					14.7					17.8					20.9					
	オフセット					オフセット					オフセット					オフセット					オフセット					
	5°	15°	30°	45°	60°	5°	15°	30°	45°	60°	5°	15°	30°	45°	60°	5°	15°	30°	45°	60°	5°	15°	30°	45°	60°	
11.0	9.6																									
12.0	9.6	9.4				7.5																				
14.0	9.0	8.7	8.3			7.5	7.5				6.5					5.7										
16.0	8.4	8.3	7.7	7.5		7.5	7.4				6.5	6.5				5.7					5.0					
18.0	8.1	7.8	7.3	7.1	7.0	7.2	6.9	6.5			6.5	6.3				5.7	5.7				5.0					
20.0	7.5	7.3	6.9	6.7	6.6	7.0	6.5	6.1	5.9		6.3	6.0	5.5			5.7	5.5				5.0	5.0				
22.0	7.1	6.8	6.6	6.3	6.3	6.5	6.2	5.8	5.6	5.5	5.9	5.6	5.2	5.0		5.5	5.2	4.8			5.0	4.8				
24.0	6.6	6.4	6.2	6.0	6.0	6.1	5.9	5.5	5.3	5.3	5.7	5.3	5.0	4.8	4.7	5.2	4.9	4.6			4.8	4.5	4.2			
26.0	6.2	6.0	5.8	5.7	5.7	5.8	5.6	5.2	5.0	5.0	5.4	5.1	4.8	4.6	4.5	5.0	4.7	4.4	4.2		4.6	4.3	4.0			
28.0	5.9	5.7	5.5	5.4		5.4	5.2	5.0	4.8	4.8	5.1	4.8	4.5	4.4	4.3	4.8	4.4	4.2	4.0	3.9	4.3	4.1	3.8	3.6		
30.0	4.6	5.1	5.2	5.1		5.1	5.0	4.8	4.6		4.8	4.6	4.3	4.2	4.2	4.5	4.2	4.0	3.8	3.8	4.2	3.9	3.6	3.5		
32.0	3.4	3.8	4.3	4.6		4.3	4.7	4.5	4.4		4.5	4.4	4.1	4.0	4.0	4.3	4.0	3.8	3.7	3.6	4.0	3.7	3.5	3.3	3.3	
34.0			3.1	3.4		3.2	3.7	4.3	4.2		3.7	4.1	3.9	3.8		4.1	3.9	3.6	3.5	3.5	3.8	3.5	3.3	3.2	3.2	
36.0							2.7	3.3	3.7		2.8	3.4	3.8	3.7		3.3	3.7	3.4	3.3		3.6	3.4	3.2	3.1	3.1	
38.0									2.6					3.2	3.5		3.1	3.3	3.2		2.9	3.2	3.0	3.0	3.0	
40.0														2.7				3.0	3.1			2.9	2.9	2.8		
42.0																			2.7				2.8	2.7		
44.0																							2.3	2.6		
46.0																								2.1		
(°)	61-84	62-84	62-84	62-84	70-84	61-84	61-84	62-84	62-84	70-84	61-84	63-84	63-84	63-84	70-84	62-84	63-84	63-84	63-84	70-84	62-84	63-84	62-84	62-84	70-84	
標準フック	25t										7.8t															
フック質量	450kg										300kg															
標準巻掛本数	2										1															

注) カウンタウエイト35t、アウトリガ張出幅 8.3m

F C 性能

63.4mブーム+1.85m+フルオートラフィングジブ

単位：t

ジブ長さ(m)	8.5					11.6					14.7					17.8					20.9				
	オフセット					オフセット					オフセット					オフセット					オフセット				
	5°	15°	30°	45°	60°	5°	15°	30°	45°	60°	5°	15°	30°	45°	60°	5°	15°	30°	45°	60°	5°	15°	30°	45°	60°
14.0	7.0	7.0				6.1					5.4														
16.0	6.8	6.6	6.3			6.1	6.0				5.4					4.7									
18.0	6.3	6.1	5.9	5.7		5.9	5.7	5.3			5.4	5.2				4.7					4.2				
20.0	6.0	5.8	5.5	5.3	5.3	5.5	5.3	5.0	4.8		5.2	4.9				4.7	4.5				4.2				
22.0	5.6	5.4	5.1	5.0	5.0	5.2	5.0	4.7	4.5	4.5	4.8	4.6	4.3			4.6	4.3				4.2	4.0			
24.0	5.3	5.1	4.8	4.7	4.7	4.9	4.7	4.4	4.3	4.2	4.5	4.3	4.1	3.9		4.3	4.0	3.8			4.0	3.7			
26.0	4.9	4.8	4.6	4.4	4.4	4.6	4.4	4.2	4.1	4.0	4.3	4.1	3.9	3.7	3.7	4.0	3.8	3.6			3.8	3.5	3.3		
28.0	4.6	4.5	4.3	4.2	4.2	4.3	4.1	3.9	3.9	3.8	4.0	3.8	3.6	3.5	3.5	3.8	3.6	3.4	3.3	3.2	3.6	3.4	3.1		
30.0	4.3	4.2	4.1	4.0		4.1	3.9	3.7	3.6	3.6	3.8	3.6	3.5	3.3	3.3	3.6	3.4	3.2	3.1	3.1	3.3	3.2	3.0	2.9	
32.0	3.9	4.0	3.9	3.8		3.8	3.7	3.5	3.4		3.6	3.4	3.3	3.2	3.2	3.4	3.2	3.0	2.9	2.9	3.2	3.0	2.8	2.7	
34.0		3.2	3.6	3.6		3.4	3.5	3.3	3.3		3.4	3.2	3.1	3.0	3.0	3.2	3.0	2.9	2.8	2.8	3.0	2.9	2.7	2.6	
36.0				2.9			2.9	3.2	3.1		3.0	3.1	2.9	2.8		3.0	2.9	2.7	2.7	2.6	2.8	2.7	2.6	2.5	
38.0									2.9					2.8	2.7			2.7	2.6	2.5		2.7	2.5	2.4	
40.0															2.6							2.4	2.3	2.2	
42.0																							2.2	2.1	
44.0																							2.0	2.0	
46.0																								1.9	
(°)	63-84	63-84	64-84	63-84	70-84	63-84	63-84	64-84	63-84	70-84	63-84	64-84	65-84	64-84	70-84	64-84	64-84	65-84	65-84	70-84	64-84	64-84	64-84	64-84	70-84
標準フック	7.8t																								
フック質量	300kg																								
標準巻掛本数	1																								

注) カウンタウエイト35t、アウトリガ張出幅 8.3m

FD性能

30.0mブーム+1.85m+フルオートラフィングジブ

単位：t

ジブ長さ(m)	8.5					11.6					14.7					17.8					20.9				
	オフセット					オフセット					オフセット					オフセット					オフセット				
作業半径(m)	5°	15°	30°	45°	60°	5°	15°	30°	45°	60°	5°	15°	30°	45°	60°	5°	15°	30°	45°	60°	5°	15°	30°	45°	60°
7.0	26.1	20.9				14.6					13.9														
8.0	24.4	19.9				14.6	14.6				13.9					13.5									
9.0	22.8	19.0	15.8			14.6	14.6				13.9					13.4					5.6				
10.0	21.5	18.2	15.3	13.6		14.6	14.5				13.9	12.4				13.0					5.6				
11.0	20.3	17.4	14.9	13.3	12.2	14.6	13.8	11.5			13.9	11.8				12.5	10.2				5.6				
12.0	19.2	16.7	14.5	13.1	12.1	14.6	13.2	11.2			13.4	11.3				11.7	9.8				5.6				
14.0	17.3	15.5	13.8	12.7	11.9	13.9	12.2	10.6	9.5	8.6	12.0	10.3	8.8			10.4	8.9				5.6	5.6			
16.0	15.8	14.4	13.2	12.4	11.8	12.6	11.3	10.0	9.2	8.5	10.8	9.5	8.3	7.4		9.3	8.2	7.0			5.6	5.6			
18.0	12.5	13.2	12.6	12.1	11.7	11.5	10.5	9.6	8.9	8.4	9.8	8.8	7.8	7.1	6.5	8.4	7.6	6.6	5.8		5.6	5.6	5.6		
20.0	9.4	10.1	10.9	11.4		10.5	9.8	9.1	8.7	8.3	8.9	8.2	7.5	6.9	6.4	7.7	7.0	6.3	5.6	5.0	5.6	5.6	5.6		
22.0	6.7	7.4	8.2	8.6		8.2	9.1	8.8	8.5	8.3	8.2	7.7	7.1	6.7	6.3	7.0	6.5	6.0	5.4	4.9	5.6	5.6	5.3	4.6	
24.0	4.6	5.1	5.8	6.1		6.0	6.8	7.8	8.3		7.2	7.2	6.8	6.5	6.3	6.5	6.1	5.7	5.3	4.8	5.6	5.5	5.0	4.5	4.0
26.0	2.9	3.3	3.8	4.0		4.3	4.9	5.7	6.2		5.3	6.2	6.6	6.4		6.0	5.7	5.4	5.1	4.8	5.4	5.2	4.8	4.3	3.9
28.0			2.1			2.8	3.3	4.0	4.3		3.8	4.6	5.6	6.2		4.7	5.4	5.2	5.0		5.0	4.8	4.6	4.2	3.9
30.0						1.5	2.0	2.5			2.6	3.2	4.0	4.5		3.4	4.2	5.0	4.9		4.5	4.6	4.4	4.1	3.8
32.0								1.2			1.5	2.0	2.7			2.3	3.0	3.9	4.5		3.3	4.2	4.2	4.0	
34.0													1.5			1.3	1.9	2.7	3.1		2.4	3.1	4.1	3.9	
36.0																		1.6			1.5	2.2	3.0	3.6	
38.0																						1.3	2.0		
40.0																							1.1		
(°)	47-84	48-84	46-84	50-84	65-84	43-84	46-84	43-84	50-84	65-84	44-84	47-84	45-84	51-84	66-84	45-84	48-84	47-84	51-84	67-84	46-84	46-84	46-84	52-84	68-84
標準フック	80t					25t										7.8t									
フック質量	1150kg					450kg										300kg									
標準巻掛本数	4					2										1									

注) カウンタウエイト23.5t、アウトリガ張出幅 8.3m

FD性能

34.1mブーム+1.85m+フルオートラフィングジブ

単位：t

ジブ長さ(m)	8.5					11.6					14.7					17.8					20.9				
	オフセット					オフセット					オフセット					オフセット					オフセット				
作業半径(m)	5°	15°	30°	45°	60°	5°	15°	30°	45°	60°	5°	15°	30°	45°	60°	5°	15°	30°	45°	60°	5°	15°	30°	45°	60°
7.0	27.5	21.5				14.6																			
8.0	25.8	20.5				14.6					13.9					13.5									
9.0	24.2	19.7	16.0			14.6	14.6				13.9					13.2									
10.0	22.8	18.8	15.6			14.6	14.6				13.9	12.8				12.8									
11.0	21.6	18.1	15.2	13.4		14.6	14.6	11.9			13.9	12.2				12.4	10.5				5.6				
12.0	20.5	17.4	14.8	13.2	12.1	14.6	14.1	11.6			13.9	11.7				12.0	10.0				5.6				
14.0	18.5	16.2	14.1	12.8	11.9	14.6	13.0	11.0	9.7		12.8	10.7	8.9			11.0	9.2				5.6	5.6			
16.0	16.3	15.1	13.5	12.5	11.8	13.9	12.1	10.4	9.4	8.6	11.5	9.9	8.4	7.4		9.9	8.5	7.1			5.6	5.6			
18.0	12.4	13.2	12.9	12.2	11.7	12.6	11.3	10.0	9.1	8.4	10.4	9.2	8.0	7.2	6.5	9.0	7.8	6.7			5.6	5.6	5.6		
20.0	9.3	10.1	10.9	11.5	11.7	10.6	10.6	9.5	8.9	8.4	9.6	8.6	7.6	6.9	6.4	8.2	7.3	6.4	5.6		5.6	5.6	5.6		
22.0	6.7	7.4	8.2	8.8		8.1	9.0	9.2	8.7	8.3	8.8	8.1	7.3	6.7	6.3	7.5	6.8	6.1	5.5	4.9	5.6	5.6	5.4	4.6	
24.0	4.5	5.1	5.9	6.3		5.9	6.8	7.8	8.4		7.0	7.6	7.0	6.6	6.2	6.9	6.4	5.8	5.3	4.8	5.6	5.6	5.1	4.5	3.9
26.0		3.3	3.9	4.2		4.1	4.9	5.8	6.4		5.2	6.1	6.7	6.4	6.2	6.0	6.0	5.6	5.2	4.7	5.6	5.4	4.9	4.3	3.9
28.0						2.7	3.3	4.1	4.5		3.6	4.5	5.5	6.3		4.5	5.4	5.3	5.0	4.7	5.4	5.1	4.7	4.2	3.8
30.0							2.0	2.6	2.9		2.4	3.1	4.0	4.6		3.2	4.0	5.1	4.9		4.2	4.8	4.5	4.1	3.8
32.0												1.9	2.7	3.1		2.1	2.8	3.8	4.5		3.1	4.0	4.3	4.0	
34.0														1.9			1.8	2.6	3.2		2.1	2.9	4.0	3.9	
36.0																		1.6	2.0			2.0	2.9	3.6	
38.0																							2.0	2.5	
40.0																								1.5	
(°)	55-84	53-84	55-84	56-84	66-84	52-84	51-84	53-84	52-84	66-84	52-84	52-84	54-84	52-84	66-84	52-84	52-84	52-84	54-84	67-84	53-84	53-84	54-84	52-84	68-84
標準フック	80t					25t										7.8t									
フック質量	1150kg					450kg										300kg									
標準巻掛本数	4					2										1									

注) カウンタウエイト23.5t、アウトリガ張出幅 8.3m

FD性能

38.3mブーム+1.85m+フルオートラフィングジブ

単位：t

ジブ長さ(m) 作業半径(m)	8.5					11.6					14.7					17.8					20.9					
	オフセット					オフセット					オフセット					オフセット					オフセット					
	5°	15°	30°	45°	60°	5°	15°	30°	45°	60°	5°	15°	30°	45°	60°	5°	15°	30°	45°	60°	5°	15°	30°	45°	60°	
7.0	25.0																									
8.0	25.0	21.6				14.6																				
9.0	25.0	20.7				14.6					13.9					12.9										
10.0	24.7	19.9	16.1			14.6	14.6				13.9					12.6										
11.0	23.4	19.1	15.7			14.6	14.6				13.9	12.6				12.2						5.6				
12.0	22.2	18.4	15.3	13.5	12.2	14.6	14.6	11.8			13.9	12.1				11.8	10.1					5.6				
14.0	20.2	17.2	14.6	13.1	12.1	14.6	13.6	11.2	9.8		13.6	11.1	9.1			11.1	9.5					5.6				
16.0	16.3	16.1	14.0	12.8	11.9	14.6	12.6	10.7	9.5	8.6	12.3	10.3	8.6			10.6	8.8	7.2				5.6	5.6			
18.0	12.5	13.3	13.5	12.5	11.8	13.5	11.8	10.2	9.2	8.5	11.2	9.6	8.2	7.3		9.6	8.2	6.9				5.6	5.6			
20.0	9.4	10.2	11.1	11.7	11.8	10.5	11.1	9.8	9.0	8.4	10.2	9.0	7.8	7.0	6.4	8.8	7.6	6.5	5.7			5.6	5.6	5.6		
22.0	6.7	7.5	8.4	9.0		8.0	9.0	9.4	8.8	8.3	9.0	8.5	7.5	6.8	6.3	8.0	7.1	6.2	5.5	4.9		5.6	5.6	5.5		
24.0	4.6	5.2	6.0	6.5		5.8	6.7	7.8	8.5	8.3	6.8	7.9	7.2	6.7	6.2	7.4	6.7	6.0	5.4	4.8		5.6	5.6	5.3	4.5	
26.0	2.9	3.4	4.1	4.4		4.0	4.8	5.8	6.4		5.0	6.0	6.9	6.5	6.2	5.8	6.3	5.7	5.2	4.8		5.6	5.6	5.0	4.4	3.9
28.0				2.7		2.6	3.2	4.1	4.6		3.5	4.4	5.5	6.3		4.2	5.3	5.5	5.1	4.7		5.3	5.3	4.8	4.3	3.8
30.0								2.6	3.0			3.0	4.0	4.6		3.0	3.9	5.1	5.0			4.0	5.0	4.6	4.2	3.8
32.0													2.7	3.2			2.7	3.8	4.5			2.9	3.8	4.4	4.1	3.8
34.0																		2.6	3.2				2.8	3.9	4.0	
36.0																			2.1					2.9	3.6	
38.0																								1.9	2.6	
(°)	56-84	57-84	59-84	56-84	67-84	56-84	57-84	57-84	58-84	67-84	58-84	58-84	58-84	60-84	67-84	58-84	58-84	59-84	58-84	68-84	58-84	59-84	58-84	60-84	68-84	
標準フック	80t					25t										7.8t										
フック質量	1150kg					450kg										300kg										
標準巻掛本数	4					2										1										

注) カウンタウエイト23.5t、アウトリガ張出幅 8.3m

FD性能

42.5mブーム+1.85m+フルオートラフィングジブ

単位：t

ジブ長さ(m) 作業半径(m)	8.5					11.6					14.7					17.8					20.9					
	オフセット					オフセット					オフセット					オフセット					オフセット					
	5°	15°	30°	45°	60°	5°	15°	30°	45°	60°	5°	15°	30°	45°	60°	5°	15°	30°	45°	60°	5°	15°	30°	45°	60°	
8.0	21.3																									
9.0	21.3	21.3				14.6																				
10.0	21.3	20.5				14.6					13.9					11.5										
11.0	21.3	19.7	15.9			14.6	14.6				13.9					11.5										
12.0	21.0	19.0	15.6	13.6		14.6	14.6				13.8	12.0				11.5						5.6				
14.0	19.5	17.8	14.9	13.3	12.1	14.6	14.1	11.4			13.1	11.4				10.8	9.4					5.6				
16.0	16.5	16.7	14.3	12.9	12.0	14.6	13.1	10.9	9.6	8.6	12.4	10.7	8.8			10.2	8.9					5.6	5.6			
18.0	12.7	13.5	13.8	12.6	11.8	13.7	12.3	10.5	9.4	8.5	11.9	10.0	8.4	7.3		9.8	8.5	7.0				5.6	5.6			
20.0	9.6	10.4	11.3	11.9	11.8	10.7	11.6	10.1	9.1	8.4	10.9	9.4	8.0	7.1	6.4	9.3	7.9	6.7	5.8			5.6	5.6	5.6		
22.0	6.9	7.7	8.6	9.2	9.4	8.1	9.1	9.7	8.9	8.3	9.0	8.8	7.7	6.9	6.3	8.6	7.4	6.4	5.6	4.9		5.6	5.6	5.5		
24.0	4.8	5.5	6.3	6.8		5.9	6.8	8.0	8.7	8.3	6.8	8.0	7.4	6.8	6.3	7.6	7.0	6.1	5.4	4.8		5.6	5.6	5.3	4.6	
26.0		3.6	4.3	4.8		4.2	5.0	6.0	6.7	7.0	5.0	6.1	7.1	6.6	6.2	5.8	6.6	5.9	5.3	4.8		5.6	5.6	5.1	4.4	3.9
28.0				3.1			3.4	4.3	4.9		3.6	4.4	5.6	6.5	6.2	4.3	5.3	5.7	5.2	4.7		5.3	5.6	4.9	4.3	3.9
30.0								2.8	3.3			3.1	4.1	4.8		3.0	3.9	5.2	5.1	4.7		4.0	5.1	4.8	4.2	3.8
32.0													2.8	3.4				3.9	4.7			2.8	3.9	4.6	4.1	3.8
34.0																		2.7	3.4				2.8	4.0	4.0	3.7
36.0																								2.9	3.8	
38.0																										2.7
(°)	61-84	60-84	62-84	60-84	67-84	61-84	60-84	60-84	61-84	67-84	61-84	61-84	61-84	63-84	67-84	60-84	63-84	61-84	64-84	68-84	60-84	61-84	63-84	63-84	68-84	
標準フック	25t					25t										7.8t										
フック質量	450kg					450kg										300kg										
標準巻掛本数	3					2										1										

注) カウンタウエイト23.5t、アウトリガ張出幅 8.3m

FD性能

46.7mブーム+1.85m+フルオートラフィングジブ

単位：t

ジブ長さ(m)	8.5					11.6					14.7					17.8					20.9						
	オフセット					オフセット					オフセット					オフセット					オフセット						
	5°	15°	30°	45°	60°	5°	15°	30°	45°	60°	5°	15°	30°	45°	60°	5°	15°	30°	45°	60°	5°	15°	30°	45°	60°		
9.0	17.5																										
10.0	17.5	17.5				14.2																					
11.0	17.5	17.5				14.2					12.0					10.1											
12.0	17.5	17.5	15.8			14.2	14.2				12.0					10.1											
14.0	16.9	16.4	15.2	13.4		14.2	14.0	11.6			12.0	11.1				10.1	9.1						5.6				
16.0	15.5	15.1	14.6	13.1	12.0	14.2	13.6	11.1	9.7		12.0	10.6	8.9			9.9	8.7						5.6				
18.0	12.8	13.6	13.7	12.8	11.9	13.4	12.8	10.7	9.5	8.5	11.5	10.2	8.5			9.4	8.3	7.0					5.6	5.6			
20.0	9.8	10.5	11.4	12.1	11.8	10.8	11.7	10.3	9.2	8.4	11.2	9.7	8.2	7.2	6.4	9.0	8.0	6.8					5.6	5.6			
22.0	7.1	7.9	8.8	9.4	9.7	8.2	9.2	9.9	9.0	8.4	9.1	9.2	7.9	7.0	6.4	8.8	7.6	6.5	5.6				5.6	5.6	5.4		
24.0	5.0	5.7	6.5	7.1		6.0	7.0	8.1	8.8	8.3	6.9	8.0	7.6	6.8	6.3	7.6	7.3	6.2	5.5	4.8			5.6	5.6	5.2		
26.0		3.8	4.6	5.0		4.3	5.1	6.1	6.9	7.3	5.1	6.1	7.3	6.7	6.2	5.8	6.9	6.0	5.4	4.8			5.6	5.6	5.1	4.5	
28.0								4.4	5.1			4.5	5.7	6.6	6.2	4.3	5.4	5.8	5.2	4.7			5.3	5.6	4.9	4.4	3.9
30.0									3.5				4.2	5.0	5.4		4.0	5.3	5.1	4.7			3.9	5.1	4.7	4.3	3.8
32.0														3.6				3.9	4.8	4.7				3.9	4.6	4.2	3.8
34.0																		3.5						2.8	4.1	4.1	3.7
36.0																									3.0	3.9	
38.0																										2.8	
(°)	64-84	63-84	64-84	65-84	68-84	63-84	65-84	65-84	64-84	68-84	65-84	65-84	65-84	65-84	68-84	64-84	65-84	66-84	66-84	69-84	64-84	63-84	65-84	65-84	69-84	69-84	
標準フック	25t					25t										7.8t											
フック質量	450kg					450kg										300kg											
標準巻掛本数	3					2										1											

注) カウンタウエイト23.5t、アウトリガ張出幅 8.3m

FD性能

50.9mブーム+1.85m+フルオートラフィングジブ

単位：t

ジブ長さ(m)	8.5					11.6					14.7					17.8					20.9							
	オフセット					オフセット					オフセット					オフセット					オフセット							
	5°	15°	30°	45°	60°	5°	15°	30°	45°	60°	5°	15°	30°	45°	60°	5°	15°	30°	45°	60°	5°	15°	30°	45°	60°			
10.0	13.8																											
11.0	13.8	13.8				11.8																						
12.0	13.8	13.8				11.8					10.1																	
14.0	13.8	13.8	13.3	13.0		11.8	11.8				10.1	10.1				6.7												
16.0	13.4	13.0	12.5	12.2	12.1	11.8	11.8	11.3			10.1	10.0				6.7								5.6				
18.0	12.3	12.1	11.7	11.5	11.4	11.5	11.2	10.7	9.5		10.1	9.6	8.4			6.7	6.7							5.6	5.6			
20.0	10.2	10.9	11.0	10.8	10.8	10.9	10.5	10.1	9.3	8.5	10.0	9.5	8.2	7.3		6.7	6.7	6.7						5.6	5.6			
22.0	7.6	8.3	9.3	9.8	10.1	8.5	9.4	9.5	9.1	8.4	9.2	9.1	7.9	7.1	6.4	6.7	6.7	6.5						5.6	5.6	5.3		
24.0	5.4	6.1	7.0	7.5	7.8	6.3	7.2	8.4	8.9	8.3	7.1	8.2	7.7	6.9	6.3	6.7	6.7	6.3	5.7					5.6	5.6	5.1		
26.0		4.3	5.0	5.5		4.5	5.4	6.4	7.2	7.5	5.3	6.3	7.4	6.8	6.2	6.2	6.7	6.1	5.6	5.0				5.6	5.6	5.0	4.5	
28.0								4.7	5.4			4.7	5.9	6.6	6.2	4.7	5.8	5.9	5.5	5.0				5.4	5.5	4.8	4.4	3.9
30.0									3.8				4.4	5.2	5.7		4.4	5.7	5.3	4.9				4.1	5.2	4.7	4.3	3.8
32.0														3.9				4.4	5.2	4.9					4.0	4.5	4.2	3.8
34.0																		4.0								4.2	4.1	3.8
36.0																										3.1	4.0	3.7
38.0																											3.0	
(°)	66-84	65-84	66-84	67-84	69-84	65-84	67-84	67-84	66-84	69-84	67-84	67-84	67-84	67-84	69-84	66-84	67-84	68-84	68-84	69-84	66-84	67-84	66-84	67-84	69-84	69-84		
標準フック	25t					25t										7.8t												
フック質量	450kg					450kg										300kg												
標準巻掛本数	2					2										1												

注) カウンタウエイト23.5t、アウトリガ張出幅 8.3m

FD性能

55.0mブーム+1.85m+フルオートラフィングジブ

単位：t

ジブ長さ(m) 作業半径(m)	8.5					11.6					14.7					17.8					20.9										
	オフセット					オフセット					オフセット					オフセット					オフセット										
	5°	15°	30°	45°	60°	5°	15°	30°	45°	60°	5°	15°	30°	45°	60°	5°	15°	30°	45°	60°	5°	15°	30°	45°	60°						
11.0	11.5																														
12.0	11.5	11.5				10.0																									
14.0	11.5	11.5	11.4			10.0	10.0				6.9					6.7															
16.0	11.2	11.0	10.6	10.4	10.4	10.0	9.9	9.7			6.9					6.7					5.6										
18.0	10.5	10.2	9.9	9.7	9.7	9.6	9.5	9.1	8.9		6.9	6.9				6.7	6.7				5.6										
20.0	9.8	9.6	9.3	9.1	9.1	9.3	8.9	8.6	8.4	8.4	6.9	6.9	6.9			6.7	6.7				5.6	5.6									
22.0	7.9	8.6	8.7	8.6	8.6	8.7	8.4	8.1	8.0	8.0	6.9	6.9	6.9	6.9		6.7	6.7	6.3			5.6	5.6									
24.0	5.7	6.4	7.2	7.8	8.1	6.5	7.4	7.6	7.5	7.5	6.9	6.9	6.9	6.9	6.4	6.7	6.7	6.1	5.6		5.6	5.6	5.0								
26.0			5.3	5.8	6.0	4.8	5.6	6.6	7.1	7.1	5.8	6.8	6.7	6.6	6.3	6.4	6.5	5.9	5.5	5.1	5.6	5.6	4.8								
28.0								4.9	5.6	6.0	4.2	5.2	6.3	6.2	6.2	4.8	5.9	5.8	5.4	5.0	5.5	5.4	4.7	4.3							
30.0									4.1							3.8	4.9	5.7	5.9		4.5	5.6	5.2	4.9	4.2	5.2	4.6	4.2	3.9		
32.0													3.6	4.3	4.7			4.5	5.1	4.9		4.1	4.4	4.1	3.8						
34.0																		3.4	4.2	4.6			4.3	4.0	3.8						
36.0																				3.1				3.3	4.0	3.7					
38.0																								3.2	3.6						
(°)	67-84	68-84	68-84	69-84	69-84	67-84	68-84	68-84	68-84	69-84	66-84	67-84	67-84	69-84	69-84	68-84	68-84	67-84	67-84	69-84	67-84	68-84	68-84	69-84	68-84	68-84	68-84	69-84	69-84		
標準フック	25t										7.8t																				
フック質量	450kg										300kg																				
標準巻掛本数	2										1																				

注) カウンタウエイト23.5t、アウトリガ張出幅 8.3m

FD性能

59.2mブーム+1.85m+フルオートラフィングジブ

単位：t

ジブ長さ(m) 作業半径(m)	8.5					11.6					14.7					17.8					20.9											
	オフセット					オフセット					オフセット					オフセット					オフセット											
	5°	15°	30°	45°	60°	5°	15°	30°	45°	60°	5°	15°	30°	45°	60°	5°	15°	30°	45°	60°	5°	15°	30°	45°	60°							
11.0	9.6																															
12.0	9.6	9.4				7.5																										
14.0	9.0	8.7	8.3			7.5	7.5				6.5					5.7																
16.0	8.4	8.3	7.7	7.5		7.5	7.4				6.5	6.5				5.7																
18.0	8.1	7.8	7.3	7.1	7.0	7.2	6.9	6.5			6.5	6.3				5.7	5.7															
20.0	7.5	7.3	6.9	6.7	6.6	7.0	6.5	6.1	5.9		6.3	6.0	5.5			5.7	5.5															
22.0	7.1	6.8	6.6	6.3	6.3	6.5	6.2	5.8	5.6	5.5	5.9	5.6	5.2	5.0		5.5	5.2	4.8														
24.0	6.1	6.4	6.2	6.0	6.0	6.1	5.9	5.5	5.3	5.3	5.7	5.3	5.0	4.8	4.7	5.2	4.9	4.6														
26.0			5.7	5.7	5.7	5.4	5.6	5.2	5.0	5.0	5.4	5.1	4.8	4.6	4.5	5.0	4.7	4.4	4.2													
28.0							4.6	5.0	4.8	4.8	4.5	4.8	4.5	4.4	4.3	4.8	4.4	4.2	4.0	3.9	4.3	4.1	3.8	3.6								
30.0								4.1	4.6				4.1	4.3	4.2	4.2		4.2	4.0	3.8	3.8	4.2	3.9	3.6	3.5							
32.0													3.9	4.0	4.0				3.8	3.7	3.6											
34.0																		3.6	3.5	3.5												
36.0																				3.3												
38.0																																
(°)	69-84	70-84	69-84	70-84	70-84	68-84	68-84	68-84	69-84	70-84	68-84	68-84	68-84	70-84	70-84	69-84	69-84	69-84	69-84	70-84	68-84	69-84	69-84	70-84	70-84	68-84	69-84	69-84	70-84	70-84		
標準フック	25t										7.8t																					
フック質量	450kg										300kg																					
標準巻掛本数	2										1																					

注) カウンタウエイト23.5t、アウトリガ張出幅 8.3m

FD性能

63.4mブーム+1.85m+フルオートラフィングジブ

単位：t

ジブ長さ(m) 作業半径(m)	8.5					11.6					14.7					17.8					20.9											
	オフセット					オフセット					オフセット					オフセット					オフセット											
	5°	15°	30°	45°	60°	5°	15°	30°	45°	60°	5°	15°	30°	45°	60°	5°	15°	30°	45°	60°	5°	15°	30°	45°	60°							
14.0	7.0	7.0				6.1					5.4																					
16.0	6.8	6.6	6.3			6.1	6.0				5.4					4.7																
18.0	6.3	6.1	5.9	5.7		5.9	5.7	5.3			5.4	5.2				4.7																
20.0	6.0	5.8	5.5	5.3	5.3	5.5	5.3	5.0	4.8		5.2	4.9				4.7	4.5															
22.0	5.6	5.4	5.1	5.0	5.0	5.2	5.0	4.7	4.5	4.5	4.8	4.6	4.3			4.6	4.3															
24.0	5.3	5.1	4.8	4.7	4.7	4.9	4.7	4.4	4.3	4.2	4.5	4.3	4.1	3.9		4.3	4.0	3.8														
26.0		4.8	4.6	4.4	4.4	4.6	4.4	4.2	4.1	4.0	4.3	4.1	3.9	3.7	3.7	4.0	3.8	3.6														
28.0			4.3	4.2	4.2		4.1	3.9	3.9	3.8	4.0	3.8	3.6	3.5	3.5	3.8	3.6	3.4	3.3	3.2	3.6	3.4	3.1									
30.0								3.7	3.6	3.6			3.5	3.3	3.3		3.4	3.2	3.1	3.1	3.3	3.2	3.0	2.9								
32.0													3.3	3.2	3.2			3.0	2.9	2.9		3.0	2.8	2.7	2.7							
34.0																			2.8	2.8												
36.0																					2.6											
38.0																																
(°)	70-84	70-84	69-84	70-84	70-84	70-84	69-84	69-84	71-84	70-84	69-84	71-84	70-84	70-84	70-84	70-84	70-84	71-84	72-84	70-84	70-84	70-84	70-84	70-84	71-84	71-84	72-84	72-84	72-84			
標準フック	25t										7.8t																					
フック質量	450kg										300kg																					
標準巻掛本数	2										1																					

注) カウンタウエイト23.5t、アウトリガ張出幅 8.3m

FE性能

30.0mブーム+1.85m+フルオートラフィングジブ

単位：t

ジブ長さ(m)	8.5					11.6					14.7					17.8					20.9				
	オフセット					オフセット					オフセット					オフセット					オフセット				
	5°	15°	30°	45°	60°	5°	15°	30°	45°	60°	5°	15°	30°	45°	60°	5°	15°	30°	45°	60°	5°	15°	30°	45°	60°
7.0	26.1	20.9				14.6					13.9														
8.0	24.4	19.9				14.6	14.6				13.9					13.5									
9.0	22.8	19.0	15.8			14.6	14.6				13.9					13.4					5.6				
10.0	21.5	18.2	15.3	13.6		14.6	14.5				13.9	12.4				13.0					5.6				
11.0	20.3	17.4	14.9	13.3	12.2	14.6	13.8	11.5			13.9	11.8				12.5	10.2				5.6				
12.0	19.2	16.7	14.5	13.1	12.1	14.6	13.2	11.2			13.4	11.3				11.7	9.8				5.6				
14.0	15.0	15.5	13.8	12.7	11.9	13.9	12.2	10.6	9.5	8.6	12.0	10.3	8.8			10.4	8.9				5.6	5.6			
16.0	10.6	11.5	12.7	12.4	11.8	12.0	11.3	10.0	9.2	8.5	10.8	9.5	8.3	7.4		9.3	8.2	7.0			5.6	5.6			
18.0	7.1	8.1	9.1	9.8	10.1	8.7	9.8	9.6	8.9	8.4	9.7	8.8	7.8	7.1	6.5	8.4	7.6	6.6	5.8		5.6	5.6	5.6		
20.0	4.4	5.2	6.2	6.8		6.0	7.1	8.3	8.7	8.3	7.2	8.2	7.5	6.9	6.4	7.7	7.0	6.3	5.6	5.0	5.6	5.6	5.6		
22.0				4.2		3.8	4.8	5.9	6.7	7.0	5.0	6.2	7.1	6.7	6.3	5.9	6.5	6.0	5.4	4.9	5.6	5.6	5.3	4.6	
24.0							2.9	3.9	4.5		3.2	4.2	5.6	6.4	6.3	4.1	5.3	5.7	5.3	4.8	5.3	5.5	5.0	4.5	4.0
26.0									2.6			2.6	3.8	4.6			3.7	5.1	5.1	4.8	3.8	5.0	4.8	4.3	3.9
28.0														2.9				3.6	4.5		2.5	3.6	4.6	4.2	3.9
30.0																			3.0			2.4	3.7	4.1	3.8
32.0																							2.5	3.4	
34.0																									2.2
(°)	58-84	60-84	62-84	59-84	65-84	58-84	57-84	59-84	57-84	65-84	57-84	57-84	61-84	59-84	66-84	60-84	60-84	61-84	61-84	67-84	58-84	58-84	60-84	60-84	68-84
標準フック	80 t										25t										7.8t				
フック質量	1150kg										450kg										300kg				
標準巻掛本数	4										2										1				

注)カウンタウエイト12t、アウトリガ張出幅 8.3m

FE性能

34.1mブーム+1.85m+フルオートラフィングジブ

単位：t

ジブ長さ(m)	8.5					11.6					14.7					17.8					20.9					
	オフセット					オフセット					オフセット					オフセット					オフセット					
	5°	15°	30°	45°	60°	5°	15°	30°	45°	60°	5°	15°	30°	45°	60°	5°	15°	30°	45°	60°	5°	15°	30°	45°	60°	
7.0	27.5	21.5				14.6																				
8.0	25.8	20.5				14.6					13.9					13.5										
9.0	24.2	19.7	16.0			14.6	14.6				13.9					13.2										
10.0	22.8	18.8	15.6			14.6	14.6				13.9	12.8				12.8										
11.0	21.6	18.1	15.2	13.4		14.6	14.6	11.9			13.9	12.2				12.4	10.5				5.6					
12.0	20.5	17.4	14.8	13.2	12.1	14.6	14.1	11.6			13.9	11.7				12.0	10.0				5.6					
14.0	15.0	16.2	14.1	12.8	11.9	14.6	13.0	11.0	9.7		12.8	10.7	8.9			11.0	9.2				5.6	5.6				
16.0	10.5	11.5	12.7	12.5	11.8	11.9	12.1	10.4	9.4	8.6	11.5	9.9	8.4	7.4		9.9	8.5	7.1			5.6	5.6				
18.0	7.1	8.1	9.2	9.9	10.3	8.6	9.7	10.0	9.1	8.4	9.6	9.2	8.0	7.2	6.5	9.0	7.8	6.7			5.6	5.6	5.6			
20.0			6.3	7.0	7.3	5.9	7.0	8.3	8.9	8.4	7.0	8.2	7.6	6.9	6.4	7.8	7.3	6.4	5.6		5.6	5.6	5.6			
22.0							4.7	5.9	6.8	7.2	4.8	6.0	7.3	6.7	6.3	5.7	6.8	6.1	5.5	4.9	5.6	5.6	5.4	4.6		
24.0									3.9	4.6			4.1	5.5	6.5	6.2	3.9	5.1	5.8	5.3	4.8	5.0	5.6	5.1	4.5	3.9
26.0														3.7	4.6	5.1		3.5	5.0	5.2	4.7	3.5	4.8	4.9	4.3	3.9
28.0															3.0				3.5	4.5	4.7		3.4	4.7	4.2	3.8
30.0																				3.0				3.6	4.1	3.8
32.0																									3.4	
(°)	64-84	66-84	65-84	66-84	66-84	64-84	63-84	63-84	64-84	66-84	63-84	63-84	64-84	63-84	66-84	63-84	63-84	64-84	64-84	67-84	63-84	64-84	65-84	66-84	68-84	
標準フック	80 t										25t										7.8t					
フック質量	1150kg										450kg										300kg					
標準巻掛本数	4										2										1					

注)カウンタウエイト12t、アウトリガ張出幅 8.3m

F E 性能

3 8 . 3 mブーム+ 1 . 8 5 m+フルオートラフィングジブ

単位：t

ジブ長さ(m)	8.5					11.6					14.7					17.8					20.9					
	オフセット					オフセット					オフセット					オフセット					オフセット					
	5°	15°	30°	45°	60°	5°	15°	30°	45°	60°	5°	15°	30°	45°	60°	5°	15°	30°	45°	60°	5°	15°	30°	45°	60°	
7.0	25.0																									
8.0	25.0	21.6				14.6																				
9.0	25.0	20.7				14.6					13.9					12.9										
10.0	24.7	19.9	16.1			14.6	14.6				13.9					12.6										
11.0	23.4	19.1	15.7			14.6	14.6				13.9	12.6				12.2							5.6			
12.0	21.8	18.4	15.3	13.5	12.2	14.6	14.6	11.8			13.9	12.1				11.8	10.1						5.6			
14.0	15.1	16.3	14.6	13.1	12.1	14.6	13.6	11.2	9.8		13.6	11.1	9.1			11.1	9.5						5.6			
16.0	10.6	11.6	12.9	12.8	11.9	11.8	12.6	10.7	9.5	8.6	12.3	10.3	8.6			10.6	8.8	7.2					5.6	5.6		
18.0	7.1	8.2	9.3	10.1	10.5	8.5	9.6	10.2	9.2	8.5	9.4	9.6	8.2	7.3		9.6	8.2	6.9					5.6	5.6		
20.0		5.3	6.4	7.2	7.5	5.7	6.9	8.3	9.0	8.4	6.8	8.1	7.8	7.0	6.4	7.6	7.6	6.5	5.7				5.6	5.6	5.6	
22.0				4.6			4.6	5.9	6.9	7.3		5.9	7.4	6.8	6.3	5.4	6.9	6.2	5.5	4.9			5.6	5.6	5.5	
24.0									4.7	5.1			5.4	6.5	6.2		5.0	6.0	5.4	4.8	4.8		4.8	5.6	5.3	4.5
26.0														4.6	5.2			4.9	5.2	4.8			4.6	5.0	4.4	3.9
28.0																		4.5	4.7					4.8	4.3	3.8
30.0																								3.5	4.2	3.8
32.0																									3.4	3.8
(°)	67-84	65-84	67-84	66-84	67-84	66-84	65-84	68-84	67-84	67-84	68-84	68-84	69-84	68-84	67-84	67-84	68-84	69-84	69-84	68-84	67-84	68-84	67-84	68-84	68-84	
標準フック	80 t					25t					7.8t															
フック質量	1150kg					450kg					300kg															
標準巻掛本数	4					2					1															

注) カウンタウエイト12t、アウトリガ張出幅 8.3m

F E 性能

4 2 . 5 mブーム+ 1 . 8 5 m+フルオートラフィングジブ

単位：t

ジブ長さ(m)	8.5					11.6					14.7					17.8					20.9					
	オフセット					オフセット					オフセット					オフセット					オフセット					
	5°	15°	30°	45°	60°	5°	15°	30°	45°	60°	5°	15°	30°	45°	60°	5°	15°	30°	45°	60°	5°	15°	30°	45°	60°	
8.0	21.3																									
9.0	21.3	21.3				14.6																				
10.0	21.3	20.5				14.6					13.9					11.5										
11.0	21.3	19.7	15.9			14.6	14.6				13.9					11.5										
12.0	21.0	19.0	15.6	13.6		14.6	14.6				13.8	12.0				11.5							5.6			
14.0	15.3	16.5	14.9	13.3	12.1	14.6	14.1	11.4			13.1	11.4				10.8	9.4						5.6			
16.0	10.8	11.8	13.1	12.9	12.0	11.9	13.1	10.9	9.6	8.6	12.4	10.7	8.8			10.2	8.9						5.6	5.6		
18.0	7.4	8.4	9.5	10.3	10.7	8.6	9.8	10.5	9.4	8.5	9.5	10.0	8.4	7.3		9.8	8.5	7.0					5.6	5.6		
20.0			6.7	7.5	7.8	5.9	7.1	8.4	9.1	8.4	6.9	8.2	8.0	7.1	6.4	7.7	7.9	6.7	5.8				5.6	5.6	5.6	
22.0					5.2			6.1	7.1	7.5		6.0	7.5	6.9	6.3	5.4	6.9	6.4	5.6	4.9			5.6	5.6	5.5	
24.0									4.9	5.4				5.6	6.6	6.3		5.0	6.1	5.4	4.8	4.7	5.6	5.3	4.6	
26.0														4.8	5.4			5.0	5.3	4.8			4.6	5.1	4.4	3.9
28.0																			4.6	4.7				4.9	4.3	3.9
30.0																				3.7				3.6	4.2	3.8
32.0																									3.5	3.8
(°)	69-84	70-84	69-84	71-84	69-84	68-84	70-84	70-84	69-84	70-84	69-84	70-84	70-84	71-84	69-84	69-84	69-84	71-84	71-84	70-84	68-84	69-84	69-84	70-84	72-84	
標準フック	25 t					25t					7.8t															
フック質量	450kg					450kg					300kg															
標準巻掛本数	3					2					1															

注) カウンタウエイト12t、アウトリガ張出幅 8.3m

FE性能

46.7mブーム+1.85m+フルオートラフィングジブ

単位：t

ジブ長さ(m)	8.5					11.6					14.7					17.8					20.9					
	オフセット					オフセット					オフセット					オフセット					オフセット					
	5°	15°	30°	45°	60°	5°	15°	30°	45°	60°	5°	15°	30°	45°	60°	5°	15°	30°	45°	60°	5°	15°	30°	45°	60°	
9.0	17.5																									
10.0	17.5	17.5				14.2																				
11.0	17.5	17.5				14.2					12.0					10.1										
12.0	17.5	17.5	15.8			14.2	14.2				12.0					10.1										
14.0	15.4	16.4	15.2	13.4		14.2	14.0	11.6			12.0	11.1				10.1	9.1						5.6			
16.0	11.0	11.9	13.3	13.1	12.0	12.0	13.4	11.1	9.7		12.0	10.6	8.9			9.9	8.7						5.6			
18.0	7.5	8.6	9.7	10.5	11.0	8.8	9.9	10.7	9.5	8.5	9.5	10.2	8.5			9.4	8.3	7.0				5.6	5.6			
20.0			6.9	7.7	8.0		7.2	8.6	9.2	8.4	6.9	8.2	8.2	7.2	6.4	7.7	8.0	6.8				5.6	5.6			
22.0								6.3	7.2	7.7		6.0	7.6	7.0	6.4		6.9	6.5	5.6			5.6	5.6	5.4		
24.0										5.6			5.6	6.7	6.3			6.2	5.5	4.8			5.6	5.2		
26.0														4.9	5.6			5.0	5.4	4.8			4.6	5.1	4.5	
28.0																			4.7	4.7				4.9	4.4	3.9
30.0																									4.3	3.8
32.0																										3.8
(°)	70-84	72-84	71-84	72-84	73-84	72-84	71-84	71-84	73-84	72-84	71-84	71-84	72-84	72-84	73-84	72-84	73-84	72-84	72-84	74-84	72-84	71-84	73-84	74-84	73-84	
標準フック	25t					25t										7.8t										
フック質量	450kg					450kg										300kg										
標準巻掛本数	3					2										1										

注)カウンタウエイト12t、アウトリガ張出幅 8.3m

FE性能

50.9mブーム+1.85m+フルオートラフィングジブ

単位：t

ジブ長さ(m)	8.5					11.6					14.7					17.8					20.9				
	オフセット					オフセット					オフセット					オフセット					オフセット				
	5°	15°	30°	45°	60°	5°	15°	30°	45°	60°	5°	15°	30°	45°	60°	5°	15°	30°	45°	60°	5°	15°	30°	45°	60°
10.0	13.8																								
11.0	13.8	13.8				11.8																			
12.0	13.8	13.8				11.8					10.1														
14.0	13.8	13.8	13.3	13.0		11.8	11.8				10.1	10.1				6.7									
16.0	11.4	12.4	12.5	12.2	12.1	11.8	11.8	11.3			10.1	10.0				6.7							5.6		
18.0	8.0	9.0	10.1	10.9	11.4	9.0	10.1	10.7	9.5		9.7	9.6	8.4			6.7	6.7					5.6	5.6		
20.0			7.3	8.1	8.4		7.4	8.8	9.3	8.5	7.1	8.4	8.2	7.3		6.7	6.7	6.7				5.6	5.6		
22.0								6.5	7.4	7.9			7.7	7.1	6.4		6.7	6.5				5.6	5.6	5.3	
24.0										5.9			5.8	6.9	6.3			6.3	5.7				5.6	5.1	
26.0													5.2	5.8				5.5	5.6	5.0			5.0	4.5	
28.0																			5.1	5.0			4.8	4.4	3.9
30.0																				4.3				4.3	3.8
32.0																									3.8
(°)	72-84	73-84	72-84	74-84	74-84	73-84	73-84	73-84	74-84	73-84	72-84	74-84	73-84	73-84	74-84	73-84	74-84	73-84	74-84	73-84	73-84	74-84	74-84	75-84	75-84
標準フック	25t										7.8t														
フック質量	450kg										300kg														
標準巻掛本数	2										1														

注)カウンタウエイト12t、アウトリガ張出幅 8.3m

FE性能

55.0mブーム+1.85m+フルオートラフィングジブ

単位：t

ジブ長さ(m)	8.5					11.6					14.7					17.8					20.9									
	オフセット					オフセット					オフセット					オフセット					オフセット									
	5°	15°	30°	45°	60°	5°	15°	30°	45°	60°	5°	15°	30°	45°	60°	5°	15°	30°	45°	60°	5°	15°	30°	45°	60°					
11.0	11.5																													
12.0	11.5	11.5				10.0																								
14.0	11.5	11.5	11.4			10.0	10.0				6.9					6.7														
16.0	11.2	11.0	10.6	10.4	10.4	10.0	9.9	9.7			6.9					6.7							5.6							
18.0		9.3	9.9	9.7	9.7	9.2	9.5	9.1	8.9		6.9	6.9				6.7	6.7						5.6							
20.0			7.6	8.3	8.7		7.7	8.6	8.4	8.4	6.9	6.9	6.9			6.7	6.7						5.6	5.6						
22.0								6.7	7.6	8.0		6.7	6.9	6.9		6.7	6.3						5.6	5.6						
24.0										6.2			6.3	6.9	6.4		6.1	5.6					5.6	5.0						
26.0													5.6	6.2			5.6	5.5	5.1					4.8						
28.0																		5.3	5.0				4.7	4.3						
30.0																								4.2	3.9					
32.0																									3.8					
(°)	75-84	74-84	74-84	75-84	75-84	74-84	74-84	74-84	74-84	75-84	74-84	73-84	74-84	74-84	74-84	76-84	74-84	74-84	75-84	74-84	75-84	74-84	75-84	74-84	74-84	75-84	75-84	76-84	76-84	76-84
標準フック	25t										7.8t																			
フック質量	450kg										300kg																			
標準巻掛本数	2										1																			

注)カウンタウエイト12t、アウトリガ張出幅 8.3m

FE性能

59.2mブーム+1.85m+フルオートラフィングジブ

単位：t

ジブ長さ(m)	8.5					11.6					14.7					17.8					20.9									
	オフセット					オフセット					オフセット					オフセット					オフセット									
	5°	15°	30°	45°	60°	5°	15°	30°	45°	60°	5°	15°	30°	45°	60°	5°	15°	30°	45°	60°	5°	15°	30°	45°	60°					
11.0	9.6																													
12.0	9.6	9.4				7.5																								
14.0	9.0	8.7	8.3			7.5	7.5				6.5					5.7														
16.0	8.4	8.3	7.7	7.5		7.5	7.4				6.5	6.5				5.7							5.0							
18.0		7.8	7.3	7.1	7.0	7.2	6.9	6.5			6.5	6.3				5.7	5.7						5.0							
20.0			6.9	6.7	6.6		6.5	6.1	5.9		6.3	6.0	5.5			5.7	5.5						5.0	5.0						
22.0								5.8	5.6	5.5		5.6	5.2	5.0		5.2	4.8						5.0	4.8						
24.0									5.3	5.3			5.0	4.8	4.7		4.6						4.5	4.2						
26.0													4.6	4.5			4.4	4.2					4.0	4.0						
28.0																		4.0	3.9				3.8	3.6						
30.0																									3.5					
32.0																									3.3					
(°)	76-84	75-84	75-84	76-84	76-84	75-84	75-84	75-84	75-84	76-84	74-84	75-84	75-84	75-84	77-84	75-84	76-84	75-84	76-84	75-84	74-84	75-84	76-84	76-84	77-84	75-84	76-84	76-84	77-84	77-84
標準フック	25t										7.8t																			
フック質量	450kg										300kg																			
標準巻掛本数	2										1																			

注)カウンタウエイト12t、アウトリガ張出幅 8.3m

FE性能

63.4mジブ+1.85m+フルオートラフィングジブ

単位：t

継ぎジブ長さ(m)	8.5					11.6					14.7					17.8					20.9									
	オフセット					オフセット					オフセット					オフセット					オフセット									
	5°	15°	30°	45°	60°	5°	15°	30°	45°	60°	5°	15°	30°	45°	60°	5°	15°	30°	45°	60°	5°	15°	30°	45°	60°					
14.0	7.0	7.0				6.1					5.4																			
16.0	6.8	6.6	6.3			6.1	6.0				5.4					4.7														
18.0	6.3	6.1	5.9	5.7		5.9	5.7	5.3			5.4	5.2				4.7							4.2							
20.0			5.5	5.3	5.3		5.3	5.0	4.8		5.2	4.9				4.7	4.5						4.2							
22.0					5.0			4.7	4.5	4.5		4.6	4.3			4.3							4.0							
24.0									4.3	4.2			4.1	3.9			3.8						3.7							
26.0														3.7	3.7			3.6						3.3						
28.0																		3.3	3.2					3.1						
30.0																									2.9					
32.0																									2.7					
(°)	75-84	76-84	76-84	77-84	76-84	76-84	76-84	76-84	76-84	77-84	75-84	75-84	76-84	76-84	77-84	76-84	76-84	76-84	77-84	76-84	77-84	76-84	76-84	76-84	77-84	76-84	76-84	77-84	77-84	77-84
標準フック											7.8t																			
フック質量											300kg																			
標準巻掛本数											1																			

注)カウンタウエイト12t、アウトリガ張出幅 8.3m

FF性能

30.0mブーム+1.85m+フルオートラフィングジブ

単位：t

ジブ長さ(m)	8.5					11.6					14.7					17.8					20.9				
	オフセット					オフセット					オフセット					オフセット					オフセット				
	5°	15°	30°	45°	60°	5°	15°	30°	45°	60°	5°	15°	30°	45°	60°	5°	15°	30°	45°	60°	5°	15°	30°	45°	60°
7.0	26.1	20.9				14.6					13.9														
8.0	24.4	19.9				14.6	14.6				13.9					13.5									
9.0	22.8	19.0	15.8			14.6	14.6				13.9					13.4					5.6				
10.0	21.5	18.2	15.3	13.6		14.6	14.5				13.9	12.4				13.0					5.6				
11.0	19.7	17.4	14.9	13.3	12.2	14.6	13.8	11.5			13.9	11.8				12.5	10.2				5.6				
12.0	15.8	16.7	14.5	13.1	12.1	14.6	13.2	11.2			13.4	11.3				11.7	9.8				5.6				
14.0	10.3	11.4	13.0	12.7	11.9	11.8	12.2	10.6	9.5	8.6	12.0	10.3	8.8			10.4	8.9				5.6	5.6			
16.0		7.5	8.8	9.6	10.1	8.0	9.3	10.0	9.2	8.5	9.1	9.5	8.3	7.4		9.3	8.2	7.0			5.6	5.6			
18.0				6.4	6.7	5.0	6.3	7.8	8.8	8.4	6.3	7.6	7.8	7.1	6.5	7.2	7.6	6.6	5.8		5.6	5.6	5.6		
20.0								5.2	6.2	6.6		5.3	6.9	6.9	6.4	4.9	6.3	6.3	5.6	5.0	5.6	5.6	5.6		
22.0									3.9	4.2			4.8	5.9	6.3		4.4	6.0	5.4	4.9	4.2	5.6	5.3	4.6	
24.0													3.9	4.5			4.3	5.3	4.8		4.1	5.0	4.5	4.0	
26.0																		3.8	4.4			4.3	4.3	3.9	
28.0																						2.9	4.1	3.9	
30.0																							2.8	3.4	
(°)	68-84	66-84	69-84	67-84	67-84	64-84	66-84	66-84	65-84	65-84	66-84	66-84	67-84	66-84	66-84	65-84	66-84	67-84	68-84	67-84	65-84	66-84	66-84	68-84	
標準フック	80 t					25t										7.8t									
フック質量	1150kg					450kg										300kg									
標準巻掛本数	4					2										1									

注) カウンタウエイト0t、アウトリガ張出幅 8.3m

FF性能

34.1mブーム+1.85m+フルオートラフィングジブ

単位：t

ジブ長さ(m)	8.5					11.6					14.7					17.8					20.9				
	オフセット					オフセット					オフセット					オフセット					オフセット				
	5°	15°	30°	45°	60°	5°	15°	30°	45°	60°	5°	15°	30°	45°	60°	5°	15°	30°	45°	60°	5°	15°	30°	45°	60°
7.0	27.5	21.5				14.6																			
8.0	25.8	20.5				14.6					13.9					13.5									
9.0	24.2	19.7	16.0			14.6	14.6				13.9					13.2									
10.0	22.8	18.8	15.6			14.6	14.6				13.9	12.8				12.8									
11.0	19.7	18.1	15.2	13.4		14.6	14.6	11.9			13.9	12.2				12.4	10.5				5.6				
12.0	15.7	17.3	14.8	13.2	12.1	14.6	14.1	11.6			13.9	11.7				12.0	10.0				5.6				
14.0	10.2	11.4	13.0	12.8	11.9	11.7	13.0	11.0	9.7		12.8	10.7	8.9			11.0	9.2				5.6	5.6			
16.0			8.8	9.7	10.3	7.9	9.2	10.4	9.4	8.6	8.9	9.9	8.4	7.4		9.7	8.5	7.1			5.6	5.6			
18.0					6.9		6.2	7.8	8.9	8.4	6.1	7.5	8.0	7.2	6.5	6.9	7.8	6.7			5.6	5.6	5.6		
20.0								5.2	6.3	6.8			6.8	6.9	6.4		6.2	6.4	5.6		5.6	5.6	5.6		
22.0													4.7	5.9	6.3			6.0	5.5	4.9		5.5	5.4	4.6	
24.0														4.6				5.3	4.8			5.1	4.5	3.9	
26.0																		3.8	4.5			4.2	4.3	3.9	
28.0																							4.1	3.8	
30.0																								3.4	
(°)	70-84	72-84	71-84	73-84	70-84	69-84	69-84	69-84	71-84	72-84	68-84	71-84	69-84	72-84	70-84	70-84	70-84	72-84	70-84	72-84	69-84	71-84	70-84	72-84	
標準フック	80 t					25t										7.8t									
フック質量	1150kg					450kg										300kg									
標準巻掛本数	4					2										1									

注) カウンタウエイト0t、アウトリガ張出幅 8.3m

FF性能

3.8. 3mブーム+1.85m+フルオートラフィングジブ

単位：t

ジブ長さ(m)	8.5					11.6					14.7					17.8					20.9				
	オフセット					オフセット					オフセット					オフセット					オフセット				
	5°	15°	30°	45°	60°	5°	15°	30°	45°	60°	5°	15°	30°	45°	60°	5°	15°	30°	45°	60°	5°	15°	30°	45°	60°
7.0	25.0																								
8.0	25.0	21.6				14.6																			
9.0	25.0	20.7				14.6					13.9					12.9									
10.0	24.7	19.9	16.1			14.6	14.6				13.9					12.6									
11.0	19.8	19.1	15.7			14.6	14.6				13.9	12.6				12.2						5.6			
12.0	15.8	17.4	15.3	13.5	12.2	14.6	14.6	11.8			13.9	12.1				11.8	10.1					5.6			
14.0	10.3	11.5	13.2	13.1	12.1	11.6	13.2	11.2	9.8		12.6	11.1	9.1			11.1	9.5					5.6			
16.0			8.9	9.9	10.5	7.8	9.2	10.7	9.5	8.6	8.8	10.3	8.6			9.6	8.8	7.2				5.6	5.6		
18.0				6.7	7.1			7.8	8.9	8.5		7.4	8.2	7.3			8.2	6.9				5.6	5.6		
20.0								6.3	6.9			6.8	7.0	6.4			6.1	6.5	5.7				5.6	5.6	
22.0													5.9	6.3				5.9	5.5	4.9			5.4	5.5	
24.0																		5.4	4.8				5.3	4.5	
26.0																			4.5					4.4	3.9
28.0																								4.1	3.8
(°)	73-84	73-84	73-84	71-84	72-84	71-84	73-84	73-84	73-84	74-84	72-84	73-84	73-84	75-84	73-84	72-84	74-84	74-84	73-84	73-84	73-84	72-84	74-84	73-84	75-84
標準フック	80t					25t					25t					7.8t									
フック質量	1150kg					450kg					450kg					300kg									
標準巻掛本数	4					2					2					1									

注) カウンタウエイト0t、アウトリガ張出幅 8.3m

FF性能

4.2. 5mブーム+1.85m+フルオートラフィングジブ

単位：t

ジブ長さ(m)	8.5					11.6					14.7					17.8					20.9				
	オフセット					オフセット					オフセット					オフセット					オフセット				
	5°	15°	30°	45°	60°	5°	15°	30°	45°	60°	5°	15°	30°	45°	60°	5°	15°	30°	45°	60°	5°	15°	30°	45°	60°
8.0	21.3																								
9.0	21.3	21.3				14.6																			
10.0	21.3	20.5				14.6					13.9					11.5									
11.0	20.0	19.7	15.9			14.6	14.6				13.9					11.5									
12.0	16.1	17.6	15.6	13.6		14.6	14.6				13.8	12.0				11.5						5.6			
14.0	10.5	11.8	13.4	13.3	12.1	11.7	13.4	11.4			12.7	11.4				10.8	9.4					5.6			
16.0			9.2	10.1	10.7		9.3	10.9	9.6	8.6	8.8	10.5	8.8			9.6	8.9					5.6	5.6		
18.0					7.4			7.9	9.1	8.5		7.5	8.4	7.3			8.4	7.0				5.6	5.6		
20.0								6.5	7.1			6.9	7.1	6.4			6.7	5.8				5.6	5.6		
22.0													6.0	6.3			6.0	5.6	4.9				5.5		
24.0																		5.4	4.8				5.3	4.6	
26.0																								4.4	3.9
28.0																									3.9
(°)	73-84	75-84	74-84	76-84	74-84	74-84	74-84	74-84	74-84	75-84	74-84	74-84	75-84	75-84	76-84	75-84	75-84	75-84	75-84	77-84	74-84	75-84	75-84	77-84	77-84
標準フック	25t					25t					25t					7.8t									
フック質量	450kg					450kg					450kg					300kg									
標準巻掛本数	3					2					2					1									

注) カウンタウエイト0t、アウトリガ張出幅 8.3m

FF性能

4.6. 7mブーム+1.85m+フルオートラフィングジブ

単位：t

ジブ長さ(m)	8.5					11.6					14.7					17.8					20.9				
	オフセット					オフセット					オフセット					オフセット					オフセット				
	5°	15°	30°	45°	60°	5°	15°	30°	45°	60°	5°	15°	30°	45°	60°	5°	15°	30°	45°	60°	5°	15°	30°	45°	60°
9.0	17.5																								
10.0	17.5	17.5				14.2																			
11.0	17.5	17.5				14.2					12.0					10.1									
12.0	16.2	17.5	15.8			14.2	14.2				12.0					10.1									
14.0		11.9	13.5	13.4		11.8	13.5	11.6			12.0	11.1				10.1	9.1					5.6			
16.0			9.3	10.3	10.9		9.4	11.1	9.7			10.6	8.9			9.6	8.7					5.6			
18.0								8.0	9.2	8.5			8.5				8.3	7.0				5.6	5.6		
20.0										7.2				7.2	6.4			6.8					5.6		
22.0														6.4				5.6						5.4	
24.0																			4.8				5.2		
26.0																								4.5	
28.0																									3.9
(°)	77-84	76-84	75-84	77-84	78-84	76-84	75-84	76-84	78-84	76-84	77-84	77-84	78-84	78-84	78-84	76-84	76-84	78-84	79-84	78-84	75-84	76-84	76-84	78-84	78-84
標準フック	25t					25t					25t					7.8t									
フック質量	450kg					450kg					450kg					300kg									
標準巻掛本数	3					2					2					1									

注) カウンタウエイト0t、アウトリガ張出幅 8.3m

FG性能

30.0mブーム+1.85m+フルオートラフィングジブ

単位：t

ジブ長さ(m)	8.5					11.6					14.7					17.8					20.9					
	オフセット					オフセット					オフセット					オフセット					オフセット					
	5°	15°	30°	45°	60°	5°	15°	30°	45°	60°	5°	15°	30°	45°	60°	5°	15°	30°	45°	60°	5°	15°	30°	45°	60°	
7.0	26.1	20.9				14.6					13.9															
8.0	24.4	19.9				14.6	14.6				13.9					13.5										
9.0	22.8	19.0	15.8			14.6	14.6				13.9					13.4						5.6				
10.0	21.5	18.2	15.3	13.6		14.6	14.5				13.9	12.4				13.0						5.6				
11.0	20.3	17.4	14.9	13.3	12.2	14.6	13.8	11.5			13.9	11.8				12.5	10.2					5.6				
12.0	19.2	16.7	14.5	13.1	12.1	14.6	13.2	11.2			13.4	11.3				11.7	9.8					5.6				
14.0	17.3	15.5	13.8	12.7	11.9	13.9	12.2	10.6	9.5	8.6	12.0	10.3	8.8			10.4	8.9					5.6	5.6			
16.0	15.8	14.4	13.2	12.4	11.8	12.6	11.3	10.0	9.2	8.5	10.8	9.5	8.3	7.4		9.3	8.2	7.0				5.6	5.6			
18.0	14.5	13.5	12.6	12.1	11.7	11.5	10.5	9.6	8.9	8.4	9.8	8.8	7.8	7.1	6.5	8.4	7.6	6.6	5.8			5.6	5.6	5.6		
20.0	13.4	12.7	12.1	11.9		10.5	9.8	9.1	8.7	8.3	8.9	8.2	7.5	6.9	6.4	7.7	7.0	6.3	5.6	5.0		5.6	5.6	5.6		
22.0	12.4	12.0	11.7	11.7		9.7	9.2	8.8	8.5	8.3	8.2	7.7	7.1	6.7	6.3	7.0	6.5	6.0	5.4	4.9		5.6	5.6	5.3	4.6	
24.0	11.6	11.4	11.4	11.6		9.0	8.7	8.4	8.3		7.6	7.2	6.8	6.5	6.3	6.5	6.1	5.7	5.3	4.8		5.6	5.5	5.0	4.5	4.0
26.0	10.9	10.9	11.1	11.6		8.4	8.3	8.2	8.2		7.0	6.8	6.6	6.4		6.0	5.7	5.4	5.1	4.8		5.4	5.2	4.8	4.3	3.9
28.0	10.3	10.5	10.9			7.9	7.9	7.9	8.1		6.5	6.4	6.3	6.3		5.5	5.4	5.2	5.0			5.0	4.8	4.6	4.2	3.9
30.0	9.3	9.6	9.8			7.4	7.5	7.7			6.1	6.1	6.1	6.2		5.2	5.1	5.0	4.9			4.7	4.6	4.4	4.1	3.8
32.0	7.7	7.9	8.0			7.0	7.2	7.6			5.7	5.8	6.0			4.8	4.8	4.9	4.8			4.3	4.3	4.2	4.0	
34.0	6.2	6.4				6.6	7.0	7.5			5.4	5.6	5.8			4.5	4.6	4.7	4.8			4.1	4.1	4.1	3.9	
36.0	5.0					6.2	6.4				5.1	5.3	5.7			4.3	4.4	4.6				3.8	3.9	3.9	3.8	
38.0						5.0	5.1				4.8	5.2	5.7			4.0	4.2	4.5				3.6	3.7	3.8		
40.0						4.0					4.6	5.0				3.8	4.1	4.4				3.4	3.5	3.7		
42.0											4.0					3.6	3.9					3.2	3.4	3.6		
44.0																3.5	3.8					3.0	3.2	3.6		
46.0																3.2						2.8	3.1			
48.0																						2.7	3.1			
(°)	10-84	20-84	34-84	50-84	65-84	10-84	20-84	35-84	50-84	65-84	10-84	20-84	35-84	51-84	66-84	10-84	20-84	35-84	51-84	67-84	10-84	20-84	35-84	52-84	68-84	
標準フック	80 t					25t										7.8t										
フック質量	1150kg					450kg										300kg										
標準巻掛本数	4					2										1										

注) カウンタウエイト71t、アウトリガ張出幅 7.0m

FG性能

34.1mブーム+1.85m+フルオートラフィングジブ

単位：t

ジブ長さ(m)	8.5					11.6					14.7					17.8					20.9					
	オフセット					オフセット					オフセット					オフセット					オフセット					
	5°	15°	30°	45°	60°	5°	15°	30°	45°	60°	5°	15°	30°	45°	60°	5°	15°	30°	45°	60°	5°	15°	30°	45°	60°	
7.0	27.5	21.5				14.6																				
8.0	25.8	20.5				14.6					13.9					13.5										
9.0	24.2	19.7	16.0			14.6	14.6				13.9					13.2										
10.0	22.8	18.8	15.6			14.6	14.6				13.9	12.8				12.8										
11.0	21.6	18.1	15.2	13.4		14.6	14.6	11.9			13.9	12.2				12.4	10.5					5.6				
12.0	20.5	17.4	14.8	13.2	12.1	14.6	14.1	11.6			13.9	11.7				12.0	10.0					5.6				
14.0	18.5	16.2	14.1	12.8	11.9	14.6	13.0	11.0	9.7		12.8	10.7	8.9			11.0	9.2					5.6	5.6			
16.0	16.9	15.1	13.5	12.5	11.8	13.9	12.1	10.4	9.4	8.6	11.5	9.9	8.4	7.4		9.9	8.5	7.1				5.6	5.6			
18.0	15.6	14.2	12.9	12.2	11.7	12.6	11.3	10.0	9.1	8.4	10.4	9.2	8.0	7.2	6.5	9.0	7.8	6.7				5.6	5.6	5.6		
20.0	14.4	13.4	12.5	12.0	11.7	11.6	10.6	9.5	8.9	8.4	9.6	8.6	7.6	6.9	6.4	8.2	7.3	6.4	5.6			5.6	5.6	5.6		
22.0	13.4	12.7	12.0	11.8		10.7	9.9	9.2	8.7	8.3	8.8	8.1	7.3	6.7	6.3	7.5	6.8	6.1	5.5	4.9		5.6	5.6	5.4	4.6	
24.0	12.5	12.0	11.7	11.6		10.0	9.4	8.8	8.5		8.1	7.6	7.0	6.6	6.2	6.9	6.4	5.8	5.3	4.8		5.6	5.6	5.1	4.5	3.9
26.0	11.7	11.5	11.4	11.5		9.3	8.9	8.5	8.4		7.5	7.1	6.7	6.4	6.2	6.4	6.0	5.6	5.2	4.7		5.6	5.4	4.9	4.3	3.9
28.0	11.1	11.0	11.1	11.5		8.7	8.5	8.3	8.2		7.0	6.8	6.5	6.3		5.9	5.7	5.3	5.0	4.7		5.4	5.1	4.7	4.2	3.8
30.0	9.3	9.6	10.0			8.2	8.1	8.1	8.2		6.6	6.4	6.3	6.2		5.5	5.4	5.1	4.9			5.0	4.8	4.5	4.1	3.8
32.0	7.6	7.9	8.2			7.7	7.7	7.9			6.2	6.1	6.1	6.1		5.2	5.1	5.0	4.8			4.7	4.5	4.3	4.0	
34.0	6.2	6.4	6.6			7.3	7.4	7.7			5.8	5.8	5.9	6.1		4.9	4.8	4.8	4.8			4.4	4.3	4.1	3.9	
36.0	4.9	5.1				6.1	6.4	6.7			5.5	5.6	5.8			4.6	4.6	4.7	4.7			4.1	4.1	4.0	3.8	
38.0	3.8	3.9				4.9	5.2				5.2	5.4	5.7			4.3	4.4	4.5				3.8	3.9	3.9	3.8	
40.0	2.9					3.9	4.1				4.8	5.1	5.4			4.1	4.2	4.4				3.6	3.7	3.8	3.7	
42.0						3.0	3.1				3.9	4.1				3.9	4.1	4.4				3.4	3.5	3.7		
44.0						2.2					3.1	3.2				3.7	3.9	4.3				3.2	3.4	3.6		
46.0											2.3					3.0	3.2					3.0	3.2	3.5		
48.0																2.3	2.5					2.9	3.1			
50.0																1.7						2.5	2.7			
(°)	10-84	20-84	35-84	51-84	66-84	10-84	20-84	37-84	52-84	66-84	10-84	20-84	35-84	51-84	66-84	10-84	20-84	35-84	51-84	67-84	10-84	20-84	35-84	52-84	68-84	
標準フック	80 t					25t										7.8t										
フック質量	1150kg					450kg										300kg										
標準巻掛本数	4					2										1										

注) カウンタウエイト71t、アウトリガ張出幅 7.0m

FG性能

38.3mブーム+1.85m+フルオートラフィングジブ

単位：t

ジブ長さ(m) 作業半径(m)	8.5					11.6					14.7					17.8					20.9				
	オフセット					オフセット					オフセット					オフセット					オフセット				
	5°	15°	30°	45°	60°	5°	15°	30°	45°	60°	5°	15°	30°	45°	60°	5°	15°	30°	45°	60°	5°	15°	30°	45°	60°
7.0	25.0																								
8.0	25.0	21.6				14.6																			
9.0	25.0	20.7				14.6					13.9					12.9									
10.0	24.7	19.9	16.1			14.6	14.6				13.9					12.6									
11.0	23.4	19.1	15.7			14.6	14.6				13.9	12.6				12.2					5.6				
12.0	22.2	18.4	15.3	13.5	12.2	14.6	14.6	11.8			13.9	12.1				11.8	10.1				5.6				
14.0	20.2	17.2	14.6	13.1	12.1	14.6	13.6	11.2	9.8		13.6	11.1	9.1			11.1	9.5				5.6				
16.0	18.4	16.1	14.0	12.8	11.9	14.6	12.6	10.7	9.5	8.6	12.3	10.3	8.6			10.6	8.8	7.2			5.6	5.6			
18.0	17.0	15.1	13.5	12.5	11.8	13.5	11.8	10.2	9.2	8.5	11.2	9.6	8.2	7.3		9.6	8.2	6.9			5.6	5.6			
20.0	15.7	14.3	13.0	12.2	11.8	12.5	11.1	9.8	9.0	8.4	10.2	9.0	7.8	7.0	6.4	8.8	7.6	6.5	5.7		5.6	5.6	5.6		
22.0	14.6	13.5	12.6	12.0		11.5	10.5	9.4	8.8	8.3	9.4	8.5	7.5	6.8	6.3	8.0	7.1	6.2	5.5	4.9	5.6	5.6	5.5		
24.0	13.7	12.9	12.2	11.9		10.7	9.9	9.1	8.6	8.3	8.7	8.0	7.2	6.7	6.2	7.4	6.7	6.0	5.4	4.8	5.6	5.6	5.3	4.5	
26.0	12.9	12.3	11.8	11.7		10.0	9.4	8.8	8.5		8.1	7.5	6.9	6.5	6.2	6.9	6.3	5.7	5.2	4.8	5.6	5.6	5.0	4.4	3.9
28.0	11.3	11.7	11.5	11.6		9.4	8.9	8.5	8.3		7.6	7.1	6.7	6.4		6.4	6.0	5.5	5.1	4.7	5.6	5.3	4.8	4.3	3.8
30.0	9.3	9.7	10.2	10.4		8.8	8.5	8.3	8.2		7.1	6.8	6.5	6.3		6.0	5.7	5.3	5.0		5.4	5.0	4.6	4.2	3.8
32.0	7.7	8.0	8.4			8.3	8.2	8.1	8.2		6.7	6.5	6.3	6.2		5.6	5.4	5.1	4.9		5.0	4.8	4.4	4.1	3.8
34.0	6.2	6.5	6.8			7.3	7.7	7.9	8.1		6.3	6.2	6.1	6.1		5.3	5.1	5.0	4.8		4.7	4.5	4.3	4.0	
36.0	5.0	5.2	5.4			6.0	6.4	6.8			5.9	5.9	6.0	6.1		4.9	4.9	4.8	4.8		4.4	4.3	4.1	3.9	
38.0	3.9	4.0	4.2			4.8	5.2	5.5			5.6	5.7	5.8			4.7	4.7	4.7	4.7		4.2	4.1	4.0	3.8	
40.0	2.9	3.0				3.8	4.1	4.3			4.7	5.0	5.5			4.4	4.5	4.6			3.9	3.9	3.9	3.8	
42.0	2.0	2.1				2.9	3.1				3.7	4.1	4.4			4.2	4.3	4.5			3.7	3.7	3.8	3.7	
44.0	1.2					2.1	2.3				2.9	3.2	3.4			3.6	4.0	4.4			3.5	3.6	3.7		
46.0						1.4	1.5				2.2	2.4				2.8	3.2	3.5			3.3	3.4	3.6		
48.0											1.5	1.6				2.2	2.4				3.0	3.3	3.5		
50.0																1.5	1.7				2.3	2.7	3.0		
55.0																						1.1			
(°)	10-84	20-84	35-84	51-84	67-84	10-84	20-84	35-84	51-84	67-84	10-84	20-84	35-84	51-84	67-84	10-84	20-84	35-84	52-84	68-84	10-84	20-84	35-84	52-84	68-84
標準フック	80t					25t					7.8t														
フック質量	1150kg					450kg					300kg														
標準巻掛本数	4					2					1														

注) カウンタウエイト71t、アウトリガ張出幅 7.0m

FG性能

42.5mブーム+1.85m+フルオートラフィングジブ

単位：t

ジブ長さ(m) 作業半径(m)	8.5					11.6					14.7					17.8					20.9				
	オフセット					オフセット					オフセット					オフセット					オフセット				
	5°	15°	30°	45°	60°	5°	15°	30°	45°	60°	5°	15°	30°	45°	60°	5°	15°	30°	45°	60°	5°	15°	30°	45°	60°
8.0	21.3																								
9.0	21.3	21.3				14.6																			
10.0	21.3	20.5				14.6					13.9					11.5									
11.0	21.3	19.7	15.9			14.6	14.6				13.9					11.5									
12.0	21.0	19.0	15.6	13.6		14.6	14.6				13.8	12.0				11.5					5.6				
14.0	19.5	17.8	14.9	13.3	12.1	14.6	14.1	11.4			13.1	11.4				10.8	9.4				5.6				
16.0	18.1	16.7	14.3	12.9	12.0	14.6	13.1	10.9	9.6	8.6	12.4	10.7	8.8			10.2	8.9				5.6	5.6			
18.0	16.7	15.8	13.8	12.6	11.8	14.4	12.3	10.5	9.4	8.5	11.9	10.0	8.4	7.3		9.8	8.5	7.0			5.6	5.6			
20.0	15.4	14.9	13.3	12.4	11.8	13.3	11.6	10.1	9.1	8.4	10.9	9.4	8.0	7.1	6.4	9.3	7.9	6.7	5.8		5.6	5.6	5.6		
22.0	14.3	14.1	12.9	12.2	11.7	12.3	10.9	9.7	8.9	8.3	10.1	8.8	7.7	6.9	6.3	8.6	7.4	6.4	5.6	4.9	5.6	5.6	5.5		
24.0	13.2	13.1	12.5	12.0		11.5	10.4	9.4	8.7	8.3	9.3	8.3	7.4	6.8	6.3	7.9	7.0	6.1	5.4	4.8	5.6	5.6	5.3	4.6	
26.0	12.3	12.2	12.1	11.8		10.7	9.9	9.1	8.6	8.2	8.7	7.9	7.1	6.6	6.2	7.3	6.6	5.9	5.3	4.8	5.6	5.6	5.1	4.4	3.9
28.0	11.2	11.3	11.3	11.3		10.1	9.4	8.8	8.4		8.1	7.5	6.9	6.5	6.2	6.8	6.3	5.7	5.2	4.7	5.6	5.6	4.9	4.3	3.9
30.0	9.5	10.0	10.2	10.2		9.5	9.0	8.5	8.3		7.6	7.1	6.7	6.4		6.4	5.9	5.5	5.1	4.7	5.6	5.3	4.8	4.2	3.8
32.0	7.9	8.2	8.7	8.8		8.9	8.6	8.3	8.2		7.2	6.8	6.5	6.3		6.0	5.6	5.3	5.0		5.4	5.0	4.6	4.1	3.8
34.0	6.4	6.8	7.1			7.4	7.9	8.1	8.2		6.8	6.5	6.3	6.2		5.6	5.4	5.1	4.9		5.1	4.8	4.4	4.0	3.7
36.0	5.2	5.4	5.7			6.1	6.5	7.0	7.2		6.4	6.2	6.1	6.1		5.3	5.1	5.0	4.8		4.8	4.5	4.3	4.0	
38.0	4.1	4.3	4.5			5.0	5.3	5.7			5.7	6.0	6.0	6.1		5.0	4.9	4.8	4.8		4.5	4.3	4.1	3.9	
40.0	3.1	3.3	3.4			4.0	4.3	4.6			4.7	5.2	5.7			4.8	4.7	4.7	4.7		4.2	4.1	4.0	3.8	
42.0	2.2	2.3	2.4			3.1	3.3	3.6			3.8	4.2	4.6			4.4	4.5	4.6	4.7		4.0	4.0	3.9	3.8	
44.0	1.4	1.5				2.3	2.5	2.7			3.0	3.3	3.7			3.6	4.1	4.5			3.8	3.8	3.8	3.7	
46.0						1.5	1.7				2.2	2.5	2.8			2.9	3.2	3.7			3.6	3.6	3.7		
48.0							1.0				1.6	1.8	2.0			2.2	2.5	2.8			3.0	3.4	3.6		
50.0											1.0	1.1				1.6	1.8	2.1			2.3	2.7	3.2		
55.0																						1.0	1.2		
(°)	10-84	20-84	35-84	51-84	67-84	10-84	20-84	35-84	51-84	67-84	10-84	20-84	35-84	51-84	67-84	10-84	20-84	35-84	52-84	68-84	10-84	20-84	35-84	52-84	68-84
標準フック	25t					25t					7.8t														
フック質量	450kg					450kg					300kg														
標準巻掛本数	3					2					1														

注) カウンタウエイト71t、アウトリガ張出幅 7.0m

FG性能

46.7mブーム+1.85m+フルオートラフィングジブ

単位：t

ジブ長さ(m)	8.5					11.6					14.7					17.8					20.9						
	オフセット					オフセット					オフセット					オフセット					オフセット						
	5°	15°	30°	45°	60°	5°	15°	30°	45°	60°	5°	15°	30°	45°	60°	5°	15°	30°	45°	60°	5°	15°	30°	45°	60°		
9.0	17.5																										
10.0	17.5	17.5				14.2																					
11.0	17.5	17.5				14.2					12.0					10.1											
12.0	17.5	17.5	15.8			14.2	14.2				12.0					10.1											
14.0	16.9	16.4	15.2	13.4		14.2	14.0	11.6			12.0	11.1				10.1	9.1						5.6				
16.0	15.5	15.1	14.6	13.1	12.0	14.2	13.6	11.1	9.7		12.0	10.6	8.9			9.9	8.7						5.6				
18.0	14.3	14.0	13.7	12.8	11.9	13.4	12.8	10.7	9.5	8.5	11.5	10.2	8.5			9.4	8.3	7.0					5.6	5.6			
20.0	13.2	13.0	12.7	12.5	11.8	12.5	12.1	10.3	9.2	8.4	11.2	9.7	8.2	7.2	6.4	9.0	8.0	6.8					5.6	5.6			
22.0	12.3	12.1	11.8	11.8	11.7	11.6	11.4	9.9	9.0	8.4	10.7	9.2	7.9	7.0	6.4	8.8	7.6	6.5	5.6				5.6	5.6	5.4		
24.0	11.4	11.2	11.1	11.0		10.8	10.6	9.6	8.8	8.3	9.9	8.7	7.6	6.8	6.3	8.4	7.3	6.2	5.5	4.8			5.6	5.6	5.2		
26.0	10.6	10.5	10.3	10.3		10.1	9.9	9.3	8.7	8.3	9.2	8.2	7.3	6.7	6.2	7.8	6.9	6.0	5.4	4.8			5.6	5.6	5.1	4.5	
28.0	9.8	9.8	9.7	9.7		9.5	9.3	9.0	8.5		8.6	7.8	7.1	6.6	6.2	7.3	6.5	5.8	5.2	4.7			5.6	5.6	4.9	4.4	3.9
30.0	9.1	9.1	9.1	9.1		8.9	8.8	8.6	8.4		8.1	7.5	6.8	6.4	6.1	6.8	6.2	5.6	5.1	4.7			5.6	5.4	4.7	4.3	3.8
32.0	8.0	8.4	8.5	8.5		8.3	8.2	8.1	8.1		7.6	7.1	6.6	6.3		6.4	5.9	5.4	5.0	4.7			5.6	5.2	4.6	4.2	3.8
34.0	6.6	6.9	7.3	7.5		7.5	7.7	7.7	7.7		7.2	6.8	6.5	6.2		6.0	5.6	5.2	4.9				5.4	5.0	4.5	4.1	3.7
36.0	5.3	5.6	6.0			6.2	6.7	7.2	7.3		6.8	6.5	6.3	6.2		5.7	5.4	5.1	4.9				5.1	4.8	4.4	4.0	
38.0	4.2	4.5	4.8			5.1	5.5	5.9	6.2		5.8	6.3	6.1	6.1		5.4	5.2	4.9	4.8				4.8	4.5	4.2	3.9	
40.0	3.2	3.5	3.7			4.1	4.4	4.8			4.8	5.3	5.8	6.1		5.1	5.0	4.8	4.7				4.5	4.3	4.1	3.9	
42.0	2.3	2.5	2.7			3.2	3.5	3.8			3.9	4.3	4.8			4.5	4.8	4.7	4.7				4.3	4.2	4.0	3.8	
44.0	1.5	1.7	1.8			2.4	2.6	2.9			3.1	3.4	3.8			3.6	4.1	4.6	4.7				4.1	4.0	3.9	3.8	
46.0						1.6	1.9	2.1			2.3	2.6	3.0			2.9	3.3	3.8					3.7	3.8	3.8	3.7	
48.0						1.0	1.1	1.3			1.6	1.9	2.2			2.2	2.6	3.0					3.0	3.5	3.7	3.7	
50.0											1.0	1.3	1.5			1.6	1.9	2.3					2.3	2.8	3.3		
55.0																							1.0	1.3	1.6		
(°)	37-84	37-84	35-84	52-84	68-84	34-84	35-84	35-84	52-84	68-84	35-84	37-84	35-84	52-84	68-84	39-84	41-84	35-84	52-84	69-84	36-84	39-84	35-84	52-84	69-84		
標準フック	25t					25t					25t					7.8t											
フック質量	450kg					450kg					450kg					300kg											
標準巻掛本数	3					2					1																

注) カウンタウエイト71t、アウトリガ張出幅 7.0m

FG性能

50.9mブーム+1.85m+フルオートラフィングジブ

単位：t

ジブ長さ(m)	8.5					11.6					14.7					17.8					20.9						
	オフセット					オフセット					オフセット					オフセット					オフセット						
	5°	15°	30°	45°	60°	5°	15°	30°	45°	60°	5°	15°	30°	45°	60°	5°	15°	30°	45°	60°	5°	15°	30°	45°	60°		
10.0	13.8																										
11.0	13.8	13.8				11.8																					
12.0	13.8	13.8				11.8					10.1																
14.0	13.8	13.8	13.3	13.0		11.8	11.8				10.1	10.1				6.7											
16.0	13.4	13.0	12.5	12.2	12.1	11.8	11.8	11.3			10.1	10.0				6.7								5.6			
18.0	12.3	12.1	11.7	11.5	11.4	11.5	11.2	10.7	9.5		10.1	9.6	8.4			6.7	6.7							5.6	5.6		
20.0	11.4	11.2	11.0	10.8	10.8	10.9	10.5	10.1	9.3	8.5	10.0	9.5	8.2	7.3		6.7	6.7	6.7					5.6	5.6			
22.0	10.5	10.4	10.3	10.2	10.2	10.1	9.9	9.5	9.1	8.4	9.4	9.1	7.9	7.1	6.4	6.7	6.7	6.5					5.6	5.6	5.3		
24.0	9.8	9.7	9.6	9.6	9.6	9.4	9.3	9.0	8.9	8.3	9.1	8.7	7.7	6.9	6.3	6.7	6.7	6.3	5.7				5.6	5.6	5.1		
26.0	9.1	9.0	8.9	8.9		8.8	8.7	8.5	8.4	8.3	8.5	8.2	7.4	6.8	6.2	6.7	6.7	6.1	5.6	5.0			5.6	5.6	5.0	4.5	
28.0	8.5	8.4	8.3	8.3		8.2	8.1	8.0	8.0		7.9	7.8	7.2	6.6	6.2	6.7	6.7	5.9	5.5	5.0			5.6	5.5	4.8	4.4	3.9
30.0	7.9	7.9	7.8	7.8		7.7	7.6	7.5	7.5		7.4	7.3	7.0	6.5	6.1	6.7	6.5	5.7	5.3	4.9			5.6	5.3	4.7	4.3	3.8
32.0	7.4	7.4	7.3	7.3		7.2	7.1	7.1	7.1		7.0	6.9	6.8	6.4		6.6	6.3	5.6	5.2	4.9			5.6	5.2	4.5	4.2	3.8
34.0	6.9	6.9	6.8	6.8		6.7	6.7	6.6	6.6		6.5	6.5	6.4	6.3		6.2	6.1	5.4	5.1				5.6	5.0	4.4	4.1	3.8
36.0	5.7	6.1	6.4	6.4		6.3	6.3	6.2	6.2		6.1	6.1	6.1	6.1		5.9	5.8	5.3	5.0				5.4	4.8	4.3	4.0	3.7
38.0	4.6	4.9	5.2			5.3	5.8	5.9	5.9		5.8	5.7	5.7	5.7		5.5	5.5	5.2	4.9				5.1	4.7	4.2	3.9	
40.0	3.6	3.9	4.1			4.3	4.7	5.1			5.0	5.4	5.4	5.4		5.2	5.2	5.1	4.9				4.8	4.5	4.1	3.9	
42.0	2.7	2.9	3.2			3.4	3.8	4.1			4.1	4.5	5.0	5.1		4.8	4.9	4.9	4.8				4.6	4.4	4.0	3.8	
44.0	1.9	2.1	2.3			2.6	2.9	3.2			3.2	3.6	4.1			4.0	4.5	4.6	4.7				4.3	4.2	3.9	3.7	
46.0	1.2	1.3	1.5			1.9	2.1	2.4			2.5	2.9	3.3			3.2	3.7	4.2					3.8	4.0	3.8	3.7	
48.0						1.2	1.4	1.6			1.8	2.1	2.5			2.5	2.9	3.4					3.1	3.6	3.7	3.6	
50.0											1.2	1.5	1.8			1.9	2.3	2.7					2.5	2.9	3.5		
55.0																		1.1					1.1	1.4	1.8		
(°)	39-84	40-84	38-84	54-84	69-84	40-84	41-84	38-84	54-84	69-84	40-84	42-84	38-84	54-84	69-84	44-84	46-84	38-84	54-84	69-84	41-84	43-84	38-84	54-84	69-84		
標準フック	25t					25t					7.8t																
フック質量	450kg					450kg					300kg																
標準巻掛本数	2					1																					

注) カウンタウエイト71t、アウトリガ張出幅 7.0m

FG性能

55.0mブーム+1.85m+フルオートラフィングジブ

単位：t

ジブ長さ(m) 作業半径(m)	8.5					11.6					14.7					17.8					20.9				
	オフセット					オフセット					オフセット					オフセット					オフセット				
	5°	15°	30°	45°	60°	5°	15°	30°	45°	60°	5°	15°	30°	45°	60°	5°	15°	30°	45°	60°	5°	15°	30°	45°	60°
11.0	11.5																								
12.0	11.5	11.5				10.0																			
14.0	11.5	11.5	11.4			10.0	10.0				6.9					6.7									
16.0	11.2	11.0	10.6	10.4	10.4	10.0	9.9	9.7			6.9					6.7								5.6	
18.0	10.5	10.2	9.9	9.7	9.7	9.6	9.5	9.1	8.9		6.9	6.9				6.7	6.7							5.6	
20.0	9.8	9.6	9.3	9.1	9.1	9.3	8.9	8.6	8.4	8.4	6.9	6.9	6.9			6.7	6.7							5.6 5.6	
22.0	9.2	9.0	8.7	8.6	8.6	8.7	8.4	8.1	8.0	8.0	6.9	6.9	6.9	6.9		6.7	6.7	6.3						5.6 5.6	
24.0	8.5	8.4	8.2	8.1	8.1	8.1	7.9	7.6	7.5	7.5	6.9	6.9	6.9	6.9	6.4	6.7	6.7	6.1	5.6					5.6 5.6 5.0	
26.0	7.9	7.8	7.7	7.6	7.6	7.6	7.4	7.2	7.1	7.1	6.9	6.9	6.7	6.6	6.3	6.6	6.5	5.9	5.5	5.1				5.6 5.6 4.8	
28.0	7.3	7.3	7.2	7.2		7.1	7.0	6.8	6.7	6.7	6.7	6.5	6.3	6.2	6.2	6.4	6.2	5.8	5.4	5.0				5.6 5.4 4.7 4.3	
30.0	6.8	6.8	6.7	6.7		6.6	6.6	6.4	6.4		6.3	6.2	6.0	5.9	5.9	6.0	5.9	5.6	5.2	4.9				5.5 5.2 4.6 4.2 3.9	
32.0	6.3	6.3	6.3	6.3		6.2	6.2	6.1	6.1		6.0	5.8	5.7	5.6	5.6	5.7	5.5	5.4	5.1	4.9				5.3 5.0 4.4 4.1 3.8	
34.0	5.9	5.9	5.9	5.9		5.8	5.8	5.8	5.7		5.6	5.5	5.4	5.3		5.4	5.3	5.1	5.0	4.9				5.2 4.9 4.3 4.0 3.8	
36.0	5.5	5.5	5.5	5.5		5.4	5.4	5.4	5.4		5.2	5.2	5.1	5.1		5.1	5.0	4.9	4.8					4.9 4.7 4.2 4.0 3.7	
38.0	4.9	5.1	5.1	5.1		5.1	5.0	5.0	5.1		4.9	4.9	4.9	4.8		4.8	4.8	4.6	4.6					4.7 4.5 4.1 3.9 3.7	
40.0	3.9	4.1	4.4			4.5	4.7	4.7	4.7		4.6	4.6	4.6	4.6		4.5	4.5	4.4	4.4					4.4 4.3 4.0 3.8	
42.0	3.0	3.2	3.5			3.6	4.0	4.4			4.3	4.3	4.3	4.3		4.2	4.2	4.2	4.2					4.2 4.1 3.9 3.7	
44.0	2.2	2.4	2.6			2.8	3.1	3.5			3.6	4.0	4.0	4.1		4.0	4.0	4.0	4.0					3.9 3.9 3.8 3.7	
46.0	1.4	1.6	1.8			2.1	2.4	2.7			2.8	3.2	3.7			3.4	3.7	3.8	3.8					3.7 3.7 3.7 3.6	
48.0			1.1			1.4	1.7	1.9			2.2	2.5	2.9			2.7	3.1	3.5						3.2 3.5 3.5 3.5	
50.0							1.0	1.2			1.5	1.9	2.2			2.0	2.4	2.9						2.6 3.1 3.3 3.4	
55.0																	1.0	1.3							1.2 1.6 2.0
(°)	43-84	44-84	40-84	55-84	69-84	44-84	42-84	44-84	55-84	69-84	45-84	46-84	40-84	55-84	69-84	47-84	43-84	40-84	55-84	69-84	44-84	46-84	49-84	55-84	69-84
標準フック	25t										7.8t														
フック質量	450kg										300kg														
標準巻掛本数	2										1														

注) カウンタウエイト71t、アウトリガ張出幅 7.0m

FG性能

59.2mブーム+1.85m+フルオートラフィングジブ

単位：t

ジブ長さ(m) 作業半径(m)	8.5					11.6					14.7					17.8					20.9				
	オフセット					オフセット					オフセット					オフセット					オフセット				
	5°	15°	30°	45°	60°	5°	15°	30°	45°	60°	5°	15°	30°	45°	60°	5°	15°	30°	45°	60°	5°	15°	30°	45°	60°
11.0	9.6																								
12.0	9.6	9.4				7.5																			
14.0	9.0	8.7	8.3			7.5	7.5				6.5					5.7									
16.0	8.4	8.3	7.7	7.5		7.5	7.4				6.5	6.5				5.7								5.0	
18.0	8.1	7.8	7.3	7.1	7.0	7.2	6.9	6.5			6.5	6.3				5.7	5.7							5.0	
20.0	7.5	7.3	6.9	6.7	6.6	7.0	6.5	6.1	5.9		6.3	6.0	5.5			5.7	5.5							5.0 5.0	
22.0	7.1	6.8	6.6	6.3	6.3	6.5	6.2	5.8	5.6	5.5	5.9	5.6	5.2	5.0		5.5	5.2	4.8						5.0 4.8	
24.0	6.6	6.4	6.2	6.0	6.0	6.1	5.9	5.5	5.3	5.3	5.7	5.3	5.0	4.8	4.7	5.2	4.9	4.6						4.8 4.5 4.2	
26.0	6.2	6.0	5.8	5.7	5.7	5.8	5.6	5.2	5.0	5.0	5.4	5.1	4.8	4.6	4.5	5.0	4.7	4.4	4.2					4.6 4.3 4.0	
28.0	5.9	5.7	5.5	5.4		5.4	5.2	5.0	4.8	4.8	5.1	4.8	4.5	4.4	4.3	4.8	4.4	4.2	4.0	3.9				4.3 4.1 3.8 3.6	
30.0	5.5	5.4	5.2	5.1		5.1	5.0	4.8	4.6		4.8	4.6	4.3	4.2	4.2	4.5	4.2	4.0	3.8	3.8				4.2 3.9 3.6 3.5	
32.0	5.2	5.1	4.9	4.9		4.9	4.7	4.5	4.4		4.5	4.4	4.1	4.0	4.0	4.3	4.0	3.8	3.7	3.6				4.0 3.7 3.5 3.3 3.3	
34.0	4.9	4.8	4.7	4.6		4.6	4.4	4.3	4.2		4.3	4.1	3.9	3.8		4.1	3.9	3.6	3.5	3.5				3.8 3.5 3.3 3.2 3.2	
36.0	4.7	4.6	4.4	4.4		4.3	4.2	4.1	4.0		4.1	3.9	3.8	3.7		3.8	3.7	3.4	3.3					3.6 3.4 3.2 3.1 3.1	
38.0	4.4	4.3	4.2	4.2		4.1	4.0	3.9	3.8		3.9	3.7	3.6	3.5		3.6	3.5	3.3	3.2					3.4 3.2 3.0 3.0 3.0	
40.0	4.1	4.1	4.0			3.9	3.8	3.7	3.7		3.7	3.5	3.4	3.4		3.5	3.3	3.2	3.1					3.3 3.1 2.9 2.8	
42.0	3.3	3.6	3.8			3.7	3.6	3.5	3.5		3.5	3.4	3.3	3.2		3.3	3.2	3.1	3.0					3.1 3.0 2.8 2.7	
44.0	2.5	2.7	3.0			3.3	3.4	3.4			3.3	3.2	3.1	3.1		3.1	3.0	2.9	2.9					2.9 2.8 2.7 2.6	
46.0	1.8	2.0	2.2			2.6	2.9	3.2			3.1	3.1	3.0			3.0	2.9	2.8	2.8					2.8 2.7 2.6 2.5	
48.0	1.1	1.3	1.5			1.9	2.1	2.4			2.4	2.8	2.8			2.8	2.7	2.7	2.6					2.7 2.6 2.5 2.4	
50.0						1.2	1.5	1.8			1.8	2.1	2.5			2.2	2.6	2.5						2.5 2.5 2.4 2.4	
55.0													1.0				1.2	1.6							1.4 1.8 2.1
(°)	44-84	45-84	46-84	57-84	70-84	45-84	46-84	43-84	57-84	70-84	48-84	49-84	45-84	57-84	70-84	50-84	47-84	48-84	57-84	70-84	47-84	49-84	52-84	57-84	70-84
標準フック	25t										7.8t														
フック質量	450kg										300kg														
標準巻掛本数	2										1														

注) カウンタウエイト71t、アウトリガ張出幅 7.0m

FG性能

63.4mブーム+1.85m+フルオートラフィングジブ

単位：t

ジブ長さ(m)	8.5					11.6					14.7					17.8					20.9					
	オフセット					オフセット					オフセット					オフセット					オフセット					
作業半径(m)	5°	15°	30°	45°	60°	5°	15°	30°	45°	60°	5°	15°	30°	45°	60°	5°	15°	30°	45°	60°	5°	15°	30°	45°	60°	
14.0	7.0	7.0				6.1					5.4															
16.0	6.8	6.6	6.3			6.1	6.0				5.4					4.7										
18.0	6.3	6.1	5.9	5.7		5.9	5.7	5.3			5.4	5.2				4.7							4.2			
20.0	6.0	5.8	5.5	5.3	5.3	5.5	5.3	5.0	4.8		5.2	4.9				4.7	4.5					4.2				
22.0	5.6	5.4	5.1	5.0	5.0	5.2	5.0	4.7	4.5	4.5	4.8	4.6	4.3			4.6	4.3					4.2	4.0			
24.0	5.3	5.1	4.8	4.7	4.7	4.9	4.7	4.4	4.3	4.2	4.5	4.3	4.1	3.9		4.3	4.0	3.8				4.0	3.7			
26.0	4.9	4.8	4.6	4.4	4.4	4.6	4.4	4.2	4.1	4.0	4.3	4.1	3.9	3.7	3.7	4.0	3.8	3.6				3.8	3.5	3.3		
28.0	4.6	4.5	4.3	4.2	4.2	4.3	4.1	3.9	3.9	3.8	4.0	3.8	3.6	3.5	3.5	3.8	3.6	3.4	3.3	3.2		3.6	3.4	3.1		
30.0	4.3	4.2	4.1	4.0		4.1	3.9	3.7	3.6	3.6	3.8	3.6	3.5	3.3	3.3	3.6	3.4	3.2	3.1	3.1		3.3	3.2	3.0	2.9	
32.0	4.0	4.0	3.9	3.8		3.8	3.7	3.5	3.4		3.6	3.4	3.3	3.2	3.2	3.4	3.2	3.0	2.9	2.9		3.2	3.0	2.8	2.7	2.7
34.0	3.8	3.7	3.6	3.6		3.6	3.5	3.3	3.3		3.4	3.2	3.1	3.0	3.0	3.2	3.0	2.9	2.8	2.8		3.0	2.9	2.7	2.6	2.6
36.0	3.6	3.5	3.4	3.4		3.4	3.3	3.2	3.1		3.2	3.1	2.9	2.8		3.0	2.9	2.7	2.7	2.6		2.8	2.7	2.6	2.5	2.4
38.0	3.3	3.3	3.2	3.2		3.2	3.1	3.0	2.9		3.0	2.9	2.8	2.7		2.9	2.7	2.6	2.5			2.7	2.5	2.4	2.3	2.3
40.0	3.1	3.1	3.0	3.0		3.0	2.9	2.8	2.8		2.8	2.8	2.6	2.6		2.7	2.6	2.4	2.4			2.5	2.4	2.3	2.2	2.2
42.0	3.0	2.9	2.8			2.8	2.7	2.7	2.6		2.7	2.6	2.5	2.4		2.5	2.4	2.3	2.3			2.4	2.3	2.2	2.1	
44.0	2.8	2.7	2.7			2.6	2.6	2.5	2.5		2.5	2.4	2.4	2.3		2.4	2.3	2.2	2.1			2.3	2.2	2.0	2.0	
46.0	2.3	2.5	2.5			2.5	2.4	2.4			2.4	2.3	2.3	2.2		2.3	2.2	2.1	2.0			2.2	2.1	1.9	1.9	
48.0	1.6	1.8	2.0			2.1	2.3	2.2			2.2	2.2	2.1			2.1	2.1	2.0	2.0			2.0	2.0	1.8	1.8	
50.0	1.0	1.1	1.3			1.5	1.8	2.1			2.0	2.0	2.0			2.0	1.9	1.9	1.9			1.9	1.9	1.8	1.7	
55.0													1.2			1.1	1.4	1.6				1.5	1.6	1.6		
60.0																								1.2		
(°)	46~84	47~84	47~84	57~84	70~84	48~84	49~84	51~84	57~84	70~84	50~84	52~84	48~84	57~84	70~84	48~84	49~84	51~84	57~84	70~84	50~84	52~84	49~84	57~84	70~84	
標準フック	7.8t																									
フック質量	300kg																									
標準巻掛本数	1																									

注) カウンタウエイト71t、アウトリガ張出幅 7.0m

F H性能

30.0mブーム+1.85m+フルオートラフィングジブ

単位：t

ジブ長さ(m)	8.5					11.6					14.7					17.8					20.9				
	オフセット					オフセット					オフセット					オフセット					オフセット				
	5°	15°	30°	45°	60°	5°	15°	30°	45°	60°	5°	15°	30°	45°	60°	5°	15°	30°	45°	60°	5°	15°	30°	45°	60°
7.0	26.1	20.9				14.6					13.9														
8.0	24.4	19.9				14.6	14.6				13.9					13.5									
9.0	22.8	19.0	15.8			14.6	14.6				13.9					13.4					5.6				
10.0	21.5	18.2	15.3	13.6		14.6	14.5				13.9	12.4				13.0					5.6				
11.0	20.3	17.4	14.9	13.3	12.2	14.6	13.8	11.5			13.9	11.8				12.5	10.2				5.6				
12.0	19.2	16.7	14.5	13.1	12.1	14.6	13.2	11.2			13.4	11.3				11.7	9.8				5.6				
14.0	17.3	15.5	13.8	12.7	11.9	13.9	12.2	10.6	9.5	8.6	12.0	10.3	8.8			10.4	8.9				5.6	5.6			
16.0	15.8	14.4	13.2	12.4	11.8	12.6	11.3	10.0	9.2	8.5	10.8	9.5	8.3	7.4		9.3	8.2	7.0			5.6	5.6			
18.0	14.5	13.5	12.6	12.1	11.7	11.5	10.5	9.6	8.9	8.4	9.8	8.8	7.8	7.1	6.5	8.4	7.6	6.6	5.8		5.6	5.6	5.6		
20.0	13.4	12.7	12.1	11.9		10.5	9.8	9.1	8.7	8.3	8.9	8.2	7.5	6.9	6.4	7.7	7.0	6.3	5.6	5.0	5.6	5.6	5.6		
22.0	11.6	12.0	11.7	11.7		9.7	9.2	8.8	8.5	8.3	8.2	7.7	7.1	6.7	6.3	7.0	6.5	6.0	5.4	4.9	5.6	5.6	5.3	4.6	
24.0	9.1	9.6	10.2	10.5		9.0	8.7	8.4	8.3		7.6	7.2	6.8	6.5	6.3	6.5	6.1	5.7	5.3	4.8	5.6	5.5	5.0	4.4	4.0
26.0	7.0	7.4	7.9	8.1		8.4	8.3	8.2	8.2		7.0	6.8	6.6	6.4		6.0	5.7	5.4	5.1	4.8	5.4	5.2	4.8	4.3	3.9
28.0	5.3	5.6	6.0			6.6	7.1	7.8	8.1		6.5	6.4	6.3	6.3		5.5	5.4	5.2	5.0		5.0	4.8	4.6	4.2	3.9
30.0	3.8	4.1	4.3			5.1	5.5	6.0			6.1	6.1	6.1	6.2		5.2	5.1	5.0	4.9		4.7	4.6	4.4	4.1	3.8
32.0	2.5	2.7	2.8			3.8	4.1	4.5			4.8	5.3	5.9			4.8	4.8	4.9	4.8		4.3	4.3	4.2	4.0	
34.0	1.4	1.5				2.6	2.9	3.2			3.6	4.1	4.6			4.4	4.6	4.7	4.8		4.1	4.1	4.1	3.9	
36.0						1.6	1.8				2.6	3.0	3.3			3.4	3.9	4.5			3.8	3.9	3.9	3.8	
38.0											1.7	2.0	2.2			2.5	2.9	3.4			3.5	3.7	3.8		
40.0												1.1				1.7	2.0	2.4			2.6	3.1	3.7		
42.0																1.0	1.2				1.9	2.3	2.8		
44.0																					1.2	1.6	1.9		
(°)	10~84	20~84	34~84	50~84	65~84	10~84	20~84	35~84	50~84	65~84	10~84	20~84	35~84	51~84	66~84	10~84	20~84	35~84	51~84	67~84	10~84	20~84	35~84	52~84	68~84
標準フック	80t					25t										7.8t									
フック質量	1150kg					450kg										300kg									
標準巻掛本数	4					2										1									

注) カウンタウエイト47t、アウトリガ張出幅 7.0m

F H性能

34.1mブーム+1.85m+フルオートラフィングジブ

単位：t

ジブ長さ(m)	8.5					11.6					14.7					17.8					20.9				
	オフセット					オフセット					オフセット					オフセット					オフセット				
	5°	15°	30°	45°	60°	5°	15°	30°	45°	60°	5°	15°	30°	45°	60°	5°	15°	30°	45°	60°	5°	15°	30°	45°	60°
7.0	27.5	21.5				14.6					13.9					13.5									
8.0	25.8	20.5				14.6					13.9					13.2									
9.0	24.2	19.7	16.0			14.6	14.6				13.9					12.8									
10.0	22.8	18.8	15.6			14.6	14.6				13.9	12.8				12.8									
11.0	21.6	18.1	15.2	13.4		14.6	14.6	11.9			13.9	12.2				12.4	10.5				5.6				
12.0	20.5	17.4	14.8	13.2	12.1	14.6	14.1	11.6			13.9	11.7				12.0	10.0				5.6				
14.0	18.5	16.2	14.1	12.8	11.9	14.6	13.0	11.0	9.7		12.8	10.7	8.9			11.0	9.2				5.6	5.6			
16.0	16.9	15.1	13.5	12.5	11.8	13.9	12.1	10.4	9.4	8.6	11.5	9.9	8.4	7.4		9.9	8.5	7.1			5.6	5.6			
18.0	15.6	14.2	12.9	12.2	11.7	12.6	11.3	10.0	9.1	8.4	10.4	9.2	8.0	7.2	6.5	9.0	7.8	6.7			5.6	5.6	5.6		
20.0	14.3	13.4	12.5	12.0	11.7	11.6	10.6	9.5	8.9	8.4	9.6	8.6	7.6	6.9	6.4	8.2	7.3	6.4	5.6		5.6	5.6	5.6		
22.0	11.5	12.1	12.0	11.8		10.7	9.9	9.2	8.7	8.3	8.8	8.1	7.3	6.7	6.3	7.5	6.8	6.1	5.5	4.9	5.6	5.6	5.4	4.6	
24.0	9.0	9.6	10.3	10.6		10.0	9.4	8.8	8.5		8.1	7.6	7.0	6.6	6.2	6.9	6.4	5.8	5.3	4.8	5.6	5.6	5.1	4.5	3.9
26.0	7.0	7.4	8.0	8.3		8.2	8.9	8.5	8.4		7.5	7.1	6.7	6.4	6.2	6.4	6.0	5.6	5.2	4.7	5.6	5.4	4.9	4.3	3.9
28.0	5.2	5.6	6.1	6.3		6.5	7.1	7.8	8.2		7.0	6.8	6.5	6.3		5.9	5.7	5.3	5.0	4.7	5.4	5.1	4.7	4.2	3.8
30.0	3.7	4.1	4.4			5.0	5.5	6.1	6.4		5.9	6.4	6.3	6.2		5.5	5.4	5.1	4.9		5.0	4.8	4.5	4.1	3.8
32.0	2.5	2.8	3.0			3.7	4.1	4.6			4.6	5.2	5.9	6.1		5.2	5.1	5.0	4.8		4.7	4.5	4.3	4.0	
34.0	1.4	1.6	1.8			2.5	2.9	3.3			3.4	4.0	4.6	4.9		4.2	4.8	4.8	4.8		4.4	4.3	4.1	3.9	
36.0						1.5	1.9	2.1			2.4	2.9	3.4			3.2	3.8	4.5	4.7		4.1	4.1	4.0	3.8	
38.0											1.6	1.9	2.3			2.3	2.8	3.4			3.2	3.9	3.9	3.8	
40.0												1.1	1.4			1.5	1.9	2.4			2.4	3.0	3.7	3.7	
42.0																	1.1	1.5			1.7	2.2	2.8		
44.0																					1.0	1.4	1.9		
46.0																								1.1	
(°)	36~84	38~84	35~84	51~84	66~84	38~84	39~84	37~84	52~84	66~84	39~84	37~84	35~84	51~84	66~84	40~84	38~84	35~84	51~84	67~84	38~84	41~84	35~84	52~84	68~84
標準フック	80t					25t										7.8t									
フック質量	1150kg					450kg										300kg									
標準巻掛本数	4					2										1									

注) カウンタウエイト47t、アウトリガ張出幅 7.0m

F H性能

38.3mブーム+1.85m+フルオートラフィングジブ

単位：t

ジブ長さ(m)	8.5					11.6					14.7					17.8					20.9				
	オフセット					オフセット					オフセット					オフセット					オフセット				
	5°	15°	30°	45°	60°	5°	15°	30°	45°	60°	5°	15°	30°	45°	60°	5°	15°	30°	45°	60°	5°	15°	30°	45°	60°
7.0	25.0																								
8.0	25.0	21.6				14.6																			
9.0	25.0	20.7				14.6					13.9					12.9									
10.0	24.7	19.9	16.1			14.6	14.6				13.9					12.6									
11.0	23.4	19.1	15.7			14.6	14.6				13.9	12.6				12.2					5.6				
12.0	22.2	18.4	15.3	13.5	12.2	14.6	14.6	11.8			13.9	12.1				11.8	10.1				5.6				
14.0	20.2	17.2	14.6	13.1	12.1	14.6	13.6	11.2	9.8		13.6	11.1	9.1			11.1	9.5				5.6				
16.0	18.4	16.1	14.0	12.8	11.9	14.6	12.6	10.7	9.5	8.6	12.3	10.3	8.6			10.6	8.8	7.2			5.6	5.6			
18.0	17.0	15.1	13.5	12.5	11.8	13.5	11.8	10.2	9.2	8.5	11.2	9.6	8.2	7.3		9.6	8.2	6.9			5.6	5.6			
20.0	14.4	14.3	13.0	12.2	11.8	12.5	11.1	9.8	9.0	8.4	10.2	9.0	7.8	7.0	6.4	8.8	7.6	6.5	5.7		5.6	5.6	5.6		
22.0	11.6	12.2	12.6	12.0		11.5	10.5	9.4	8.8	8.3	9.4	8.5	7.5	6.8	6.3	8.0	7.1	6.2	5.5	4.9	5.6	5.6	5.5		
24.0	9.1	9.7	10.4	10.8		10.3	9.9	9.1	8.6	8.3	8.7	8.0	7.2	6.7	6.2	7.4	6.7	6.0	5.4	4.8	5.6	5.6	5.3	4.5	
26.0	7.0	7.5	8.2	8.5		8.1	8.9	8.8	8.5		8.1	7.5	6.9	6.5	6.2	6.9	6.3	5.7	5.2	4.8	5.6	5.6	5.0	4.4	3.9
28.0	5.3	5.7	6.3	6.5		6.4	7.0	7.8	8.3		7.3	7.1	6.7	6.4		6.4	6.0	5.5	5.1	4.7	5.6	5.3	4.8	4.3	3.8
30.0	3.8	4.2	4.6	4.8		4.9	5.4	6.1	6.6		5.7	6.5	6.5	6.3		6.0	5.7	5.3	5.0		5.4	5.0	4.6	4.2	3.8
32.0	2.5	2.9	3.2			3.6	4.1	4.7	5.0		4.4	5.1	5.9	6.2		5.2	5.4	5.1	4.9		5.0	4.8	4.4	4.1	3.8
34.0	1.4	1.7	2.0			2.4	2.9	3.4	3.6		3.3	3.9	4.6	5.0		4.0	4.7	5.0	4.8		4.7	4.5	4.3	4.0	
36.0						1.5	1.8	2.2			2.3	2.8	3.4	3.8		3.0	3.6	4.5	4.8		3.9	4.3	4.1	3.9	
38.0								1.2			1.4	1.9	2.4			2.1	2.7	3.4	3.8		3.0	3.7	4.0	3.8	
40.0												1.0	1.4			1.3	1.8	2.4			2.2	2.8	3.6	3.8	
42.0																	1.0	1.5			1.5	2.0	2.7	3.2	
44.0																						1.3	1.9		
46.0																								1.2	
(°)	43-84	44-84	45-84	51-84	67-84	44-84	45-84	43-84	51-84	67-84	44-84	43-84	45-84	51-84	67-84	45-84	44-84	47-84	52-84	68-84	46-84	46-84	52-84	68-84	
標準フック	80t					25t					7.8t														
フック質量	1150kg					450kg					300kg														
標準巻掛本数	4					2					1														

注) カウンタウエイト47t、アウトリガ張出幅 7.0m

F H性能

42.5mブーム+1.85m+フルオートラフィングジブ

単位：t

ジブ長さ(m)	8.5					11.6					14.7					17.8					20.9				
	オフセット					オフセット					オフセット					オフセット					オフセット				
	5°	15°	30°	45°	60°	5°	15°	30°	45°	60°	5°	15°	30°	45°	60°	5°	15°	30°	45°	60°	5°	15°	30°	45°	60°
8.0	21.3																								
9.0	21.3	21.3				14.6																			
10.0	21.3	20.5				14.6					13.9					11.5									
11.0	21.3	19.7	15.9			14.6	14.6				13.9					11.5									
12.0	21.0	19.0	15.6	13.6		14.6	14.6				13.8	12.0				11.5					5.6				
14.0	19.5	17.8	14.9	13.3	12.1	14.6	14.1	11.4			13.1	11.4				10.8	9.4				5.6				
16.0	18.1	16.7	14.3	12.9	12.0	14.6	13.1	10.9	9.6	8.6	12.4	10.7	8.8			10.2	8.9				5.6	5.6			
18.0	16.7	15.8	13.8	12.6	11.8	14.4	12.3	10.5	9.4	8.5	11.9	10.0	8.4	7.3		9.8	8.5	7.0			5.6	5.6			
20.0	14.5	14.9	13.3	12.4	11.8	13.3	11.6	10.1	9.1	8.4	10.9	9.4	8.0	7.1	6.4	9.3	7.9	6.7	5.8		5.6	5.6	5.6		
22.0	11.8	12.3	12.9	12.2	11.7	12.3	10.9	9.7	8.9	8.3	10.1	8.8	7.7	6.9	6.3	8.6	7.4	6.4	5.6	4.9	5.6	5.6	5.5		
24.0	9.3	9.9	10.6	11.1		10.4	10.4	9.4	8.7	8.3	9.3	8.3	7.4	6.8	6.3	7.9	7.0	6.1	5.4	4.8	5.6	5.6	5.3	4.6	
26.0	7.2	7.8	8.4	8.9		8.3	9.0	9.1	8.6	8.2	8.7	7.9	7.1	6.6	6.2	7.3	6.6	5.9	5.3	4.8	5.6	5.6	5.1	4.4	3.9
28.0	5.5	6.0	6.5	6.9		6.5	7.2	8.0	8.4		7.3	7.5	6.9	6.5	6.2	6.8	6.3	5.7	5.2	4.7	5.6	5.6	4.9	4.3	3.9
30.0	4.0	4.4	4.9	5.2		5.0	5.6	6.3	6.8		5.8	6.6	6.7	6.4		6.4	5.9	5.5	5.1	4.7	5.6	5.3	4.8	4.2	3.8
32.0	2.7	3.1	3.5	3.7		3.7	4.2	4.9	5.3		4.5	5.2	6.1	6.3		5.2	5.6	5.3	5.0		5.4	5.0	4.6	4.1	3.8
34.0	1.6	1.9	2.3			2.6	3.1	3.6	3.9		3.4	4.0	4.8	5.3		4.0	4.8	5.1	4.9		4.9	4.8	4.4	4.0	3.7
36.0				1.2		1.6	2.0	2.5	2.7		2.4	2.9	3.6	4.0		3.0	3.7	4.6	4.8		3.9	4.5	4.3	4.0	
38.0								1.5			1.5	2.0	2.6	2.9		2.1	2.7	3.5	4.0		3.0	3.7	4.1	3.9	
40.0													1.6			1.3	1.9	2.6	3.0		2.2	2.9	3.7	3.8	
42.0																		1.7	2.0		1.5	2.1	2.8	3.3	
44.0																						1.4	2.0	2.4	
46.0																								1.3	
(°)	48-84	49-84	47-84	51-84	67-84	48-84	50-84	48-84	51-84	67-84	48-84	50-84	51-84	67-84	49-84	51-84	51-84	52-84	68-84	49-84	50-84	50-84	52-84	68-84	
標準フック	25t					25t					7.8t														
フック質量	450kg					450kg					300kg														
標準巻掛本数	3					2					1														

注) カウンタウエイト47t、アウトリガ張出幅 7.0m

F H性能

46.7mブーム+1.85m+フルオートラフィングジブ

単位：t

ジブ長さ(m) 作業半径(m)	8.5					11.6					14.7					17.8					20.9					
	オフセット					オフセット					オフセット					オフセット					オフセット					
	5°	15°	30°	45°	60°	5°	15°	30°	45°	60°	5°	15°	30°	45°	60°	5°	15°	30°	45°	60°	5°	15°	30°	45°	60°	
9.0	17.5																									
10.0	17.5	17.5				14.2																				
11.0	17.5	17.5				14.2					12.0					10.1										
12.0	17.5	17.5	15.8			14.2	14.2				12.0					10.1										
14.0	16.9	16.4	15.2	13.4		14.2	14.0	11.6			12.0	11.1				10.1	9.1						5.6			
16.0	15.5	15.1	14.6	13.1	12.0	14.2	13.6	11.1	9.7		12.0	10.6	8.9			9.9	8.7						5.6			
18.0	14.3	14.0	13.7	12.8	11.9	13.4	12.8	10.7	9.5	8.5	11.5	10.2	8.5			9.4	8.3	7.0					5.6	5.6		
20.0	13.2	13.0	12.7	12.5	11.8	12.5	12.1	10.3	9.2	8.4	11.2	9.7	8.2	7.2	6.4	9.0	8.0	6.8					5.6	5.6		
22.0	11.9	12.1	11.8	11.8	11.7	11.6	11.4	9.9	9.0	8.4	10.7	9.2	7.9	7.0	6.4	8.8	7.6	6.5	5.6				5.6	5.6	5.4	
24.0	9.5	10.1	10.8	11.0		10.5	10.6	9.6	8.8	8.3	9.9	8.7	7.6	6.8	6.3	8.4	7.3	6.2	5.5	4.8		5.6	5.6	5.2		
26.0	7.4	7.9	8.6	9.1		8.4	9.2	9.3	8.7	8.3	9.2	8.2	7.3	6.7	6.2	7.8	6.9	6.0	5.4	4.8		5.6	5.6	5.1	4.5	
28.0	5.6	6.1	6.7	7.1		6.6	7.3	8.2	8.5		7.4	7.8	7.1	6.6	6.2	7.3	6.5	5.8	5.2	4.7		5.6	5.6	4.9	4.4	3.9
30.0	4.2	4.6	5.1	5.4		5.1	5.7	6.5	7.0		5.9	6.7	6.8	6.4	6.1	6.5	6.2	5.6	5.1	4.7		5.6	5.4	4.7	4.3	3.8
32.0	2.9	3.3	3.7	4.0		3.8	4.4	5.1	5.5		4.6	5.3	6.2	6.3		5.2	5.9	5.4	5.0	4.7		5.6	5.2	4.6	4.2	3.8
34.0	1.8	2.1	2.5	2.7		2.7	3.2	3.8	4.2		3.4	4.1	4.9	5.4		4.0	4.8	5.2	4.9			4.9	5.0	4.5	4.1	3.7
36.0							2.2	2.7	3.0		2.4	3.0	3.7	4.2		3.0	3.7	4.7	4.9			3.9	4.7	4.4	4.0	
38.0								1.7	1.9			2.1	2.7	3.1		2.1	2.8	3.6	4.2			3.0	3.8	4.2	3.9	
40.0													1.8	2.1			1.9	2.7	3.1			2.2	2.9	3.8	3.9	
42.0																		1.8	2.2			1.5	2.1	2.9	3.5	
44.0																							1.4	2.1	2.6	
46.0																								1.4	1.8	
(°)	51~84	53~84	54~84	52~84	68~84	54~84	53~84	52~84	52~84	68~84	54~84	54~84	53~84	55~84	68~84	54~84	54~84	54~84	56~84	69~84	52~84	53~84	53~84	55~84	69~84	
標準フック	25t					25t										7.8t										
フック質量	450kg					450kg										300kg										
標準巻掛本数	3					2										1										

注) カウンタウエイト47t、アウトリガ張出幅 7.0m

F H性能

50.9mブーム+1.85m+フルオートラフィングジブ

単位：t

ジブ長さ(m) 作業半径(m)	8.5					11.6					14.7					17.8					20.9					
	オフセット					オフセット					オフセット					オフセット					オフセット					
	5°	15°	30°	45°	60°	5°	15°	30°	45°	60°	5°	15°	30°	45°	60°	5°	15°	30°	45°	60°	5°	15°	30°	45°	60°	
10.0	13.8																									
11.0	13.8	13.8				11.8																				
12.0	13.8	13.8				11.8					10.1															
14.0	13.8	13.8	13.3	13.0		11.8	11.8				10.1	10.1				6.7										
16.0	13.4	13.0	12.5	12.2	12.1	11.8	11.8	11.3			10.1	10.0				6.7							5.6			
18.0	12.3	12.1	11.7	11.5	11.4	11.5	11.2	10.7	9.5		10.1	9.6	8.4			6.7	6.7					5.6	5.6			
20.0	11.4	11.2	11.0	10.8	10.8	10.9	10.5	10.1	9.3	8.5	10.0	9.5	8.2	7.3		6.7	6.7	6.7				5.6	5.6			
22.0	10.5	10.4	10.3	10.2	10.2	10.1	9.9	9.5	9.1	8.4	9.4	9.1	7.9	7.1	6.4	6.7	6.7	6.5				5.6	5.6	5.3		
24.0	9.8	9.7	9.6	9.6	9.6	9.4	9.3	9.0	8.9	8.3	9.1	8.7	7.7	6.9	6.3	6.7	6.7	6.3	5.7			5.6	5.6	5.1		
26.0	7.8	8.4	8.9	8.9		8.6	8.7	8.5	8.4	8.3	8.5	8.2	7.4	6.8	6.2	6.7	6.7	6.1	5.6	5.0		5.6	5.6	5.0	4.5	
28.0	6.1	6.6	7.2	7.6		6.9	7.6	8.0	8.0		7.6	7.8	7.2	6.6	6.2	6.7	6.7	5.9	5.5	5.0		5.6	5.5	4.8	4.4	3.9
30.0	4.6	5.0	5.6	5.9		5.4	6.0	6.8	7.3		6.1	6.9	7.0	6.5	6.1	6.7	6.5	5.7	5.3	4.9		5.6	5.3	4.7	4.3	3.8
32.0	3.3	3.7	4.2	4.5		4.1	4.6	5.3	5.8		4.7	5.5	6.4	6.4		5.6	6.3	5.6	5.2	4.9		5.6	5.2	4.5	4.2	3.8
34.0	2.2	2.5	3.0	3.2		2.9	3.4	4.1	4.5		3.6	4.3	5.1	5.7		4.4	5.2	5.4	5.1			5.0	5.0	4.4	4.1	3.8
36.0				2.1			2.4	3.0	3.3		2.6	3.2	4.0	4.5		3.4	4.1	5.1	5.0			4.0	4.8	4.3	4.0	3.7
38.0								2.0	2.3			2.3	3.0	3.4		2.5	3.2	4.0	4.6			3.1	3.9	4.2	3.9	
40.0													2.0	2.4			2.3	3.1	3.6			2.3	3.0	4.0	3.9	
42.0																		2.2	2.7				2.2	3.1	3.7	
44.0																			1.8					2.3	2.8	
46.0																								1.6	2.0	
(°)	55~84	56~84	57~84	55~84	69~84	57~84	56~84	55~84	56~84	69~84	57~84	56~84	56~84	58~84	69~84	57~84	57~84	57~84	57~84	69~84	57~84	57~84	56~84	58~84	69~84	
標準フック	25t										7.8t															
フック質量	450kg										300kg															
標準巻掛本数	2										1															

注) カウンタウエイト47t、アウトリガ張出幅 7.0m

F H性能

55.0mブーム+1.85m+フルオートラフィングジブ

単位：t

ジブ長さ(m)	8.5					11.6					14.7					17.8					20.9				
	オフセット					オフセット					オフセット					オフセット					オフセット				
	5°	15°	30°	45°	60°	5°	15°	30°	45°	60°	5°	15°	30°	45°	60°	5°	15°	30°	45°	60°	5°	15°	30°	45°	60°
11.0	11.5																								
12.0	11.5	11.5				10.0																			
14.0	11.5	11.5	11.4			10.0	10.0				6.9					6.7									
16.0	11.2	11.0	10.6	10.4	10.4	10.0	9.9	9.7			6.9					6.7					5.6				
18.0	10.5	10.2	9.9	9.7	9.7	9.6	9.5	9.1	8.9		6.9	6.9				6.7	6.7				5.6				
20.0	9.8	9.6	9.3	9.1	9.1	9.3	8.9	8.6	8.4	8.4	6.9	6.9	6.9			6.7	6.7				5.6	5.6			
22.0	9.2	9.0	8.7	8.6	8.6	8.7	8.4	8.1	8.0	8.0	6.9	6.9	6.9	6.9		6.7	6.7	6.3			5.6	5.6			
24.0	8.5	8.4	8.2	8.1	8.1	8.1	7.9	7.6	7.5	7.5	6.9	6.9	6.9	6.9	6.4	6.7	6.7	6.1	5.6		5.6	5.6	5.0		
26.0	7.9	7.8	7.7	7.6	7.6	7.6	7.4	7.2	7.1	7.1	6.9	6.9	6.7	6.6	6.3	6.6	6.5	5.9	5.5	5.1	5.6	5.6	4.8		
28.0	6.3	6.8	7.2	7.2		7.1	7.0	6.8	6.7	6.7	6.7	6.5	6.3	6.2	6.2	6.4	6.2	5.8	5.4	5.0	5.6	5.4	4.7	4.3	
30.0	4.8	5.3	5.9	6.2		5.6	6.2	6.4	6.4		6.3	6.2	6.0	5.9	5.9	6.0	5.9	5.6	5.2	4.9	5.5	5.2	4.6	4.2	3.9
32.0	3.6	4.0	4.5	4.8		4.3	4.8	5.6	6.1		5.2	5.8	5.7	5.6	5.6	5.7	5.5	5.4	5.1	4.9	5.3	5.0	4.4	4.1	3.8
34.0		2.8	3.3	3.5		3.1	3.7	4.3	4.7		4.0	4.7	5.4	5.3		4.6	5.3	5.1	5.0	4.9	5.1	4.9	4.3	4.0	3.8
36.0				2.4			2.6	3.2	3.6		3.0	3.6	4.4	4.9		3.5	4.3	4.9	4.8		4.1	4.7	4.2	4.0	3.7
38.0									2.5		2.1	2.7	3.4	3.8		2.6	3.3	4.2	4.6		3.2	4.0	4.1	3.9	3.7
40.0													2.5	2.9			2.5	3.3	3.8		2.4	3.1	4.0	3.8	
42.0														2.0				2.4	2.9			2.4	3.2	3.7	
44.0																			2.1				2.5	3.0	
46.0																							1.7	2.2	
(°)	59-84	58-84	59-84	58-84	69-84	59-84	59-84	60-84	59-84	69-84	57-84	59-84	59-84	58-84	69-84	59-84	59-84	60-84	59-84	69-84	59-84	59-84	59-84	60-84	69-84
標準フック	25t										7.8t														
フック質量	450kg										300kg														
標準巻掛本数	2										1														

注) カウンタウエイト47t、アウトリガ張出幅 7.0m

F H性能

59.2mブーム+1.85m+フルオートラフィングジブ

単位：t

ジブ長さ(m)	8.5					11.6					14.7					17.8					20.9					
	オフセット					オフセット					オフセット					オフセット					オフセット					
	5°	15°	30°	45°	60°	5°	15°	30°	45°	60°	5°	15°	30°	45°	60°	5°	15°	30°	45°	60°	5°	15°	30°	45°	60°	
11.0	9.6																									
12.0	9.6	9.4				7.5																				
14.0	9.0	8.7	8.3			7.5	7.5				6.5					5.7										
16.0	8.4	8.3	7.7	7.5		7.5	7.4				6.5	6.5				5.7					5.0					
18.0	8.1	7.8	7.3	7.1	7.0	7.2	6.9	6.5			6.5	6.3				5.7	5.7				5.0					
20.0	7.5	7.3	6.9	6.7	6.6	7.0	6.5	6.1	5.9		6.3	6.0	5.5			5.7	5.5				5.0	5.0				
22.0	7.1	6.8	6.6	6.3	6.3	6.5	6.2	5.8	5.6	5.5	5.9	5.6	5.2	5.0		5.5	5.2	4.8			5.0	4.8				
24.0	6.6	6.4	6.2	6.0	6.0	6.1	5.9	5.5	5.3	5.3	5.7	5.3	5.0	4.8	4.7	5.2	4.9	4.6			4.8	4.5	4.2			
26.0	6.2	6.0	5.8	5.7	5.7	5.8	5.6	5.2	5.0	5.0	5.4	5.1	4.8	4.6	4.5	5.0	4.7	4.4	4.2		4.6	4.3	4.0			
28.0	5.9	5.7	5.5	5.4		5.4	5.2	5.0	4.8	4.8	5.1	4.8	4.5	4.4	4.3	4.8	4.4	4.2	4.0	3.9	4.3	4.1	3.8	3.6		
30.0	5.2	5.4	5.2	5.1		5.1	5.0	4.8	4.6		4.8	4.6	4.3	4.2	4.2	4.5	4.2	4.0	3.8	3.8	4.2	3.9	3.6	3.5		
32.0	3.9	4.3	4.8	4.9		4.8	4.7	4.5	4.4		4.5	4.4	4.1	4.0	4.0	4.3	4.0	3.8	3.7	3.6	4.0	3.7	3.5	3.3	3.3	
34.0	2.8	3.2	3.6	3.9		3.7	4.2	4.3	4.2		4.3	4.1	3.9	3.8		4.1	3.9	3.6	3.5	3.5	3.8	3.5	3.3	3.2	3.2	
36.0				2.8		2.7	3.2	3.8	4.0		3.3	3.9	3.8	3.7		3.8	3.7	3.4	3.3		3.6	3.4	3.2	3.1	3.1	
38.0								2.8	3.1		2.4	2.9	3.6	3.5		2.9	3.5	3.3	3.2		3.4	3.2	3.0	3.0	3.0	
40.0									2.2				2.7	3.2			2.7	3.2	3.1		2.6	3.1	2.9	2.8		
42.0														2.3				2.6	3.0			2.5	2.8	2.7		
44.0																			2.3				2.7	2.6		
46.0																							2.0	2.5		
(°)	59-84	60-84	62-84	60-84	70-84	59-84	61-84	61-84	59-84	70-84	59-84	61-84	61-84	60-84	70-84	61-84	61-84	62-84	61-84	70-84	61-84	61-84	61-84	61-84	62-84	70-84
標準フック	25t										7.8t															
フック質量	450kg										300kg															
標準巻掛本数	2										1															

注) カウンタウエイト47t、アウトリガ張出幅 7.0m

F H性能

63.4mブーム+1.85m+フルオートラフィングジブ

単位：t

ジブ長さ(m)	8.5					11.6					14.7					17.8					20.9				
	オフセット					オフセット					オフセット					オフセット					オフセット				
	5°	15°	30°	45°	60°	5°	15°	30°	45°	60°	5°	15°	30°	45°	60°	5°	15°	30°	45°	60°	5°	15°	30°	45°	60°
14.0	7.0	7.0				6.1					5.4														
16.0	6.8	6.6	6.3			6.1	6.0				5.4					4.7									
18.0	6.3	6.1	5.9	5.7		5.9	5.7	5.3			5.4	5.2				4.7					4.2				
20.0	6.0	5.8	5.5	5.3	5.3	5.5	5.3	5.0	4.8		5.2	4.9				4.7	4.5				4.2				
22.0	5.6	5.4	5.1	5.0	5.0	5.2	5.0	4.7	4.5	4.5	4.8	4.6	4.3			4.6	4.3				4.2	4.0			
24.0	5.3	5.1	4.8	4.7	4.7	4.9	4.7	4.4	4.3	4.2	4.5	4.3	4.1	3.9		4.3	4.0	3.8			4.0	3.7			
26.0	4.9	4.8	4.6	4.4	4.4	4.6	4.4	4.2	4.1	4.0	4.3	4.1	3.9	3.7	3.7	4.0	3.8	3.6			3.8	3.5	3.3		
28.0	4.6	4.5	4.3	4.2	4.2	4.3	4.1	3.9	3.9	3.8	4.0	3.8	3.6	3.5	3.5	3.8	3.6	3.4	3.3	3.2	3.6	3.4	3.1		
30.0	4.3	4.2	4.1	4.0		4.1	3.9	3.7	3.6	3.6	3.8	3.6	3.5	3.3	3.3	3.6	3.4	3.2	3.1	3.1	3.3	3.2	3.0	2.9	
32.0	4.0	4.0	3.9	3.8		3.8	3.7	3.5	3.4		3.6	3.4	3.3	3.2	3.2	3.4	3.2	3.0	2.9	2.9	3.2	3.0	2.8	2.7	
34.0	3.3	3.7	3.6	3.6		3.6	3.5	3.3	3.3		3.4	3.2	3.1	3.0	3.0	3.2	3.0	2.9	2.8	2.8	3.0	2.9	2.7	2.6	
36.0		2.7	3.1	3.4		2.9	3.3	3.2	3.1		3.2	3.1	2.9	2.8		3.0	2.9	2.7	2.7	2.6	2.8	2.7	2.6	2.5	
38.0							2.5	3.0	2.9		2.6	2.9	2.8	2.7		2.9	2.7	2.6	2.5		2.7	2.5	2.4	2.3	
40.0									2.5				2.6	2.6			2.6	2.4	2.4		2.5	2.4	2.3	2.2	
42.0														2.4				2.3	2.3			2.3	2.2	2.1	
44.0																			2.1				2.0	2.0	
46.0																							1.9	1.9	
(°)	62-84	61-84	62-84	63-84	70-84	61-84	61-84	62-84	62-84	70-84	61-84	63-84	63-84	62-84	70-84	62-84	63-84	63-84	63-84	70-84	62-84	63-84	62-84	64-84	70-84
標準フック	7.8t																								
フック質量	300kg																								
標準巻掛本数	1																								

注) カウンタウエイト47t、アウトリガ張出幅 7.0m

FI性能

30.0mブーム+1.85m+フルオートラフィングジブ

単位：t

ジブ長さ(m)	8.5					11.6					14.7					17.8					20.9				
	オフセット					オフセット					オフセット					オフセット					オフセット				
	5°	15°	30°	45°	60°	5°	15°	30°	45°	60°	5°	15°	30°	45°	60°	5°	15°	30°	45°	60°	5°	15°	30°	45°	60°
7.0	26.1	20.9				14.6					13.9														
8.0	24.4	19.9				14.6	14.6				13.9					13.5									
9.0	22.8	19.0	15.8			14.6	14.6				13.9					13.4					5.6				
10.0	21.5	18.2	15.3	13.6		14.6	14.5				13.9	12.4				13.0					5.6				
11.0	20.3	17.4	14.9	13.3	12.2	14.6	13.8	11.5			13.9	11.8				12.5	10.2				5.6				
12.0	19.2	16.7	14.5	13.1	12.1	14.6	13.2	11.2			13.4	11.3				11.7	9.8				5.6				
14.0	17.3	15.5	13.8	12.7	11.9	13.9	12.2	10.6	9.5	8.6	12.0	10.3	8.8			10.4	8.9				5.6	5.6			
16.0	15.8	14.4	13.2	12.4	11.8	12.6	11.3	10.0	9.2	8.5	10.8	9.5	8.3	7.4		9.3	8.2	7.0			5.6	5.6			
18.0	13.4	13.5	12.6	12.1	11.7	11.5	10.5	9.6	8.9	8.4	9.8	8.8	7.8	7.1	6.5	8.4	7.6	6.6	5.8		5.6	5.6	5.6		
20.0	10.3	11.0	11.7	11.9		10.5	9.8	9.1	8.7	8.3	8.9	8.2	7.5	6.9	6.4	7.7	7.0	6.3	5.6	5.0	5.6	5.6	5.6		
22.0	7.7	8.3	9.1	9.5		9.1	9.2	8.8	8.5	8.3	8.2	7.7	7.1	6.7	6.3	7.0	6.5	6.0	5.4	4.9	5.6	5.6	5.3	4.6	
24.0	5.5	6.0	6.6	7.0		6.9	7.7	8.4	8.3		7.6	7.2	6.8	6.5	6.3	6.5	6.1	5.7	5.3	4.8	5.6	5.5	5.0	4.5	4.0
26.0	3.7	4.2	4.7	4.8		5.1	5.8	6.5	7.0		6.2	6.8	6.6	6.4		6.0	5.7	5.4	5.1	4.8	5.4	5.2	4.8	4.3	3.9
28.0	2.3	2.6	3.0			3.6	4.1	4.8	5.1		4.6	5.4	6.3	6.3		5.5	5.4	5.2	5.0		5.0	4.8	4.6	4.2	3.9
30.0			1.5			2.3	2.8	3.3			3.3	4.0	4.7	5.2		4.1	4.9	5.0	4.9		4.7	4.6	4.4	4.1	3.8
32.0						1.2	1.6	1.9			2.2	2.7	3.4			3.0	3.7	4.6	4.8		4.0	4.3	4.2	4.0	
34.0											1.2	1.7	2.2			2.0	2.6	3.3	3.8		3.0	3.8	4.1	3.9	
36.0													1.1			1.1	1.7	2.3			2.1	2.8	3.6	3.8	
38.0																		1.3			1.3	1.9	2.6		
40.0																						1.1	1.7		
(°)	43-84	44-84	40-84	50-84	65-84	39-84	41-84	43-84	50-84	65-84	40-84	43-84	41-84	51-84	66-84	41-84	44-84	43-84	51-84	67-84	43-84	42-84	46-84	52-84	68-84
標準フック	80t					25t										7.8t									
フック質量	1150kg					450kg										300kg									
標準巻掛本数	4					2										1									

注)カウンタウエイト35t、アウトリガ張出幅 7.0m

FI性能

34.1mブーム+1.85m+フルオートラフィングジブ

単位：t

ジブ長さ(m)	8.5					11.6					14.7					17.8					20.9				
	オフセット					オフセット					オフセット					オフセット					オフセット				
	5°	15°	30°	45°	60°	5°	15°	30°	45°	60°	5°	15°	30°	45°	60°	5°	15°	30°	45°	60°	5°	15°	30°	45°	60°
7.0	27.5	21.5				14.6																			
8.0	25.8	20.5				14.6					13.9					13.5									
9.0	24.2	19.7	16.0			14.6	14.6				13.9					13.2									
10.0	22.8	18.8	15.6			14.6	14.6				13.9	12.8				12.8									
11.0	21.6	18.1	15.2	13.4		14.6	14.6	11.9			13.9	12.2				12.4	10.5				5.6				
12.0	20.5	17.4	14.8	13.2	12.1	14.6	14.1	11.6			13.9	11.7				12.0	10.0				5.6				
14.0	18.5	16.2	14.1	12.8	11.9	14.6	13.0	11.0	9.7		12.8	10.7	8.9			11.0	9.2				5.6	5.6			
16.0	16.9	15.1	13.5	12.5	11.8	13.9	12.1	10.4	9.4	8.6	11.5	9.9	8.4	7.4		9.9	8.5	7.1			5.6	5.6			
18.0	13.3	14.1	12.9	12.2	11.7	12.6	11.3	10.0	9.1	8.4	10.4	9.2	8.0	7.2	6.5	9.0	7.8	6.7			5.6	5.6	5.6		
20.0	10.3	11.0	11.8	12.0	11.7	11.5	10.6	9.5	8.9	8.4	9.6	8.6	7.6	6.9	6.4	8.2	7.3	6.4	5.6		5.6	5.6	5.6		
22.0	7.6	8.3	9.1	9.6		9.0	9.8	9.2	8.7	8.3	8.8	8.1	7.3	6.7	6.3	7.5	6.8	6.1	5.5	4.9	5.6	5.6	5.4	4.6	
24.0	5.5	6.0	6.7	7.1		6.8	7.6	8.6	8.5		7.8	7.6	7.0	6.6	6.2	6.9	6.4	5.8	5.3	4.8	5.6	5.6	5.1	4.5	3.9
26.0	3.7	4.2	4.8	5.1		5.0	5.7	6.6	7.2		6.0	6.9	6.7	6.4	6.2	6.4	6.0	5.6	5.2	4.7	5.6	5.4	4.9	4.3	3.9
28.0		2.6	3.1	3.3		3.5	4.1	4.8	5.3		4.4	5.2	6.3	6.3		5.2	5.7	5.3	5.0	4.7	5.4	5.1	4.7	4.2	3.8
30.0						2.2	2.7	3.3	3.7		3.1	3.8	4.7	5.3		3.9	4.8	5.1	4.9		4.9	4.8	4.5	4.1	3.8
32.0							1.5	2.0			2.0	2.6	3.4	3.8		2.8	3.5	4.5	4.8		3.8	4.5	4.3	4.0	
34.0												1.6	2.2	2.5		1.8	2.5	3.3	3.9		2.8	3.6	4.1	3.9	
36.0													1.2				1.5	2.2	2.7		1.9	2.6	3.6	3.8	
38.0																		1.3			1.1	1.7	2.6	3.1	
40.0																						1.0	1.7	2.1	
(°)	52-84	50-84	51-84	51-84	66-84	49-84	47-84	49-84	52-84	66-84	49-84	48-84	47-84	51-84	66-84	49-84	49-84	49-84	51-84	67-84	47-84	47-84	51-84	52-84	68-84
標準フック	80t					25t										7.8t									
フック質量	1150kg					450kg										300kg									
標準巻掛本数	4					2										1									

注)カウンタウエイト35t、アウトリガ張出幅 7.0m

F I 性能

38.3mジブ+1.85m+フルオートラフィングジブ

単位：t

継ジブ長さ(m)	8.5					11.6					14.7					17.8					20.9				
	オフセット					オフセット					オフセット					オフセット					オフセット				
	5°	15°	30°	45°	60°	5°	15°	30°	45°	60°	5°	15°	30°	45°	60°	5°	15°	30°	45°	60°	5°	15°	30°	45°	60°
7.0	25.0																								
8.0	25.0	21.6				14.6																			
9.0	25.0	20.7				14.6					13.9				12.9										
10.0	24.7	19.9	16.1			14.6	14.6				13.9				12.6										
11.0	23.4	19.1	15.7			14.6	14.6				13.9	12.6			12.2						5.6				
12.0	22.2	18.4	15.3	13.5	12.2	14.6	14.6	11.8			13.9	12.1			11.8	10.1					5.6				
14.0	20.2	17.2	14.6	13.1	12.1	14.6	13.6	11.2	9.8		13.6	11.1	9.1		11.1	9.5					5.6				
16.0	17.3	16.1	14.0	12.8	11.9	14.6	12.6	10.7	9.5	8.6	12.3	10.3	8.6		10.6	8.8	7.2				5.6	5.6			
18.0	13.4	14.2	13.5	12.5	11.8	13.5	11.8	10.2	9.2	8.5	11.2	9.6	8.2	7.3	9.6	8.2	6.9				5.6	5.6			
20.0	10.3	11.1	11.9	12.2	11.8	11.4	11.1	9.8	9.0	8.4	10.2	9.0	7.8	7.0	8.8	7.6	6.5	5.7			5.6	5.6	5.6		
22.0	7.7	8.4	9.3	9.8		8.9	9.8	9.4	8.8	8.3	9.4	8.5	7.5	6.8	8.0	7.1	6.2	5.5	4.9		5.6	5.6	5.5		
24.0	5.5	6.1	6.9	7.4		6.7	7.5	8.6	8.6	8.3	7.6	8.0	7.2	6.7	7.4	6.7	6.0	5.4	4.8		5.6	5.6	5.3	4.5	
26.0	3.8	4.3	4.9	5.3		4.9	5.6	6.6	7.2		5.8	6.8	6.9	6.5	6.2	6.6	6.3	5.7	5.2	4.8	5.6	5.6	5.0	4.4	3.9
28.0	2.3	2.7	3.3	3.5		3.4	4.0	4.9	5.4		4.3	5.1	6.2	6.4		5.0	6.0	5.5	5.1	4.7	5.6	5.3	4.8	4.3	3.8
30.0				2.0		2.1	2.7	3.4	3.8		3.0	3.7	4.7	5.4		3.7	4.6	5.3	5.0		4.7	5.0	4.6	4.2	3.8
32.0								2.1	2.4			2.5	3.4	3.9		2.6	3.4	4.4	4.9		3.6	4.5	4.4	4.1	3.8
34.0													2.2	2.6			2.3	3.3	3.9		2.6	3.4	4.3	4.0	
36.0																	2.2	2.7			1.7	2.5	3.5	3.9	
38.0																		1.7				1.6	2.5	3.1	
40.0																						1.6	2.2		
(°)	53-84	54-84	56-84	53-84	67-84	53-84	55-84	54-84	55-84	67-84	56-84	55-84	55-84	57-84	67-84	55-84	55-84	56-84	55-84	68-84	53-84	54-84	55-84	57-84	68-84
標準フック	80t					25t					7.8t														
フック質量	1150kg					450kg					300kg														
標準巻掛本数	4					2					1														

注) カウンタウエイト35t、アウトリガ張出幅 7.0m

F I 性能

42.5mブーム+1.85m+フルオートラフィングジブ

単位：t

ジブ長さ(m)	8.5					11.6					14.7					17.8					20.9				
	オフセット					オフセット					オフセット					オフセット					オフセット				
	5°	15°	30°	45°	60°	5°	15°	30°	45°	60°	5°	15°	30°	45°	60°	5°	15°	30°	45°	60°	5°	15°	30°	45°	60°
8.0	21.3																								
9.0	21.3	21.3				14.6																			
10.0	21.3	20.5				14.6					13.9				11.5										
11.0	21.3	19.7	15.9			14.6	14.6				13.9				11.5										
12.0	21.0	19.0	15.6	13.6		14.6	14.6				13.8	12.0			11.5						5.6				
14.0	19.5	17.8	14.9	13.3	12.1	14.6	14.1	11.4			13.1	11.4			10.8	9.4					5.6				
16.0	17.5	16.7	14.3	12.9	12.0	14.6	13.1	10.9	9.6	8.6	12.4	10.7	8.8		10.2	8.9					5.6	5.6			
18.0	13.6	14.4	13.8	12.6	11.8	14.4	12.3	10.5	9.4	8.5	11.9	10.0	8.4	7.3	9.8	8.5	7.0				5.6	5.6			
20.0	10.5	11.2	12.1	12.4	11.8	11.5	11.6	10.1	9.1	8.4	10.9	9.4	8.0	7.1	9.3	7.9	6.7	5.8			5.6	5.6	5.6		
22.0	7.9	8.6	9.5	10.0	10.3	9.0	9.9	9.7	8.9	8.3	9.8	8.8	7.7	6.9	8.6	7.4	6.4	5.6	4.9		5.6	5.6	5.5		
24.0	5.7	6.4	7.1	7.7		6.8	7.7	8.8	8.7	8.3	7.7	8.3	7.4	6.8	7.9	7.0	6.1	5.4	4.8		5.6	5.6	5.3	4.6	
26.0	4.0	4.5	5.2	5.6		5.0	5.8	6.8	7.5	7.8	5.9	6.9	7.1	6.6	6.2	6.6	6.6	5.9	5.3	4.8	5.6	5.6	5.1	4.4	3.9
28.0		3.0	3.5	3.9		3.5	4.2	5.1	5.6		4.3	5.2	6.4	6.5	6.2	5.0	6.1	5.7	5.2	4.7	5.6	5.6	4.9	4.3	3.9
30.0				2.4			2.8	3.6	4.1		3.1	3.8	4.8	5.6		3.7	4.7	5.5	5.1	4.7	4.7	5.3	4.8	4.2	3.8
32.0								2.3	2.7			2.6	3.5	4.1		2.6	3.4	4.5	5.0		3.5	4.5	4.6	4.1	3.8
34.0													2.4	2.9			2.4	3.4	4.1		2.5	3.4	4.4	4.0	3.7
36.0																	2.3	2.9				2.5	3.6	4.0	
38.0																							2.6	3.3	
40.0																								2.3	
(°)	59-84	57-84	59-84	57-84	67-84	59-84	58-84	57-84	58-84	67-84	58-84	58-84	58-84	60-84	67-84	58-84	58-84	59-84	61-84	68-84	58-84	59-84	60-84	60-84	68-84
標準フック	25t					25t					7.8t														
フック質量	450kg					450kg					300kg														
標準巻掛本数	3					2					1														

注) カウンタウエイト35t、アウトリガ張出幅 7.0m

FI性能

46.7mブーム+1.85m+フルオートラフィングジブ

単位：t

ジブ長さ(m)	8.5					11.6					14.7					17.8					20.9						
	オフセット					オフセット					オフセット					オフセット					オフセット						
	5°	15°	30°	45°	60°	5°	15°	30°	45°	60°	5°	15°	30°	45°	60°	5°	15°	30°	45°	60°	5°	15°	30°	45°	60°		
9.0	17.5																										
10.0	17.5	17.5				14.2																					
11.0	17.5	17.5				14.2					12.0					10.1											
12.0	17.5	17.5	15.8			14.2	14.2				12.0					10.1											
14.0	16.9	16.4	15.2	13.4		14.2	14.0	11.6			12.0	11.1				10.1	9.1						5.6				
16.0	15.5	15.1	14.6	13.1	12.0	14.2	13.6	11.1	9.7		12.0	10.6	8.9			9.9	8.7						5.6				
18.0	13.7	14.0	13.7	12.8	11.9	13.4	12.8	10.7	9.5	8.5	11.5	10.2	8.5			9.4	8.3	7.0					5.6	5.6			
20.0	10.7	11.4	12.3	12.5	11.8	11.6	12.1	10.3	9.2	8.4	11.2	9.7	8.2	7.2	6.4	9.0	8.0	6.8					5.6	5.6			
22.0	8.0	8.8	9.7	10.2	10.5	9.1	10.0	9.9	9.0	8.4	9.9	9.2	7.9	7.0	6.4	8.8	7.6	6.5	5.6				5.6	5.6	5.4		
24.0	5.9	6.5	7.3	7.9		6.9	7.8	8.9	8.8	8.3	7.7	8.7	7.6	6.8	6.3	8.4	7.3	6.2	5.5	4.8			5.6	5.6	5.2		
26.0	4.1	4.7	5.4	5.9		5.1	5.9	6.9	7.7	8.0	5.9	6.9	7.3	6.7	6.2	6.6	6.9	6.0	5.4	4.8			5.6	5.6	5.1	4.5	
28.0		3.2	3.8	4.1		3.6	4.3	5.2	5.8		4.4	5.3	6.5	6.6	6.2	5.1	6.1	5.8	5.2	4.7			5.6	5.6	4.9	4.4	3.9
30.0							3.0	3.8	4.3		3.1	3.9	4.9	5.7	6.1	3.7	4.7	5.6	5.1	4.7			4.7	5.4	4.7	4.3	3.8
32.0										2.9				3.6	4.3		3.5	4.6	5.0	4.7			3.5	4.5	4.6	4.2	3.8
34.0														3.1				3.4	4.2				2.5	3.5	4.5	4.1	3.7
36.0																			3.1					2.5	3.6	4.0	
38.0																									2.7	3.4	
40.0																										2.5	
(°)	61-84	60-84	62-84	63-84	68-84	61-84	60-84	62-84	61-84	68-84	61-84	63-84	63-84	62-84	68-84	62-84	63-84	64-84	63-84	69-84	60-84	61-84	63-84	63-84	63-84	69-84	
標準フック	25t					25t										7.8t											
フック質量	450kg					450kg										300kg											
標準巻掛本数	3					2										1											

注)カウンタウエイト35t、アウトリガ張出幅 7.0m

FI性能

50.9mブーム+1.85m+フルオートラフィングジブ

単位：t

ジブ長さ(m)	8.5					11.6					14.7					17.8					20.9						
	オフセット					オフセット					オフセット					オフセット					オフセット						
	5°	15°	30°	45°	60°	5°	15°	30°	45°	60°	5°	15°	30°	45°	60°	5°	15°	30°	45°	60°	5°	15°	30°	45°	60°		
10.0	13.8																										
11.0	13.8	13.8				11.8																					
12.0	13.8	13.8				11.8					10.1																
14.0	13.8	13.8	13.3	13.0		11.8	11.8				10.1	10.1				6.7											
16.0	13.4	13.0	12.5	12.2	12.1	11.8	11.8	11.3			10.1	10.0				6.7								5.6			
18.0	12.3	12.1	11.7	11.5	11.4	11.5	11.2	10.7	9.5		10.1	9.6	8.4			6.7	6.7							5.6	5.6		
20.0	11.1	11.2	11.0	10.8	10.8	10.9	10.5	10.1	9.3	8.5	10.0	9.5	8.2	7.3		6.7	6.7	6.7						5.6	5.6		
22.0	8.5	9.2	10.1	10.2	10.2	9.4	9.9	9.5	9.1	8.4	9.4	9.1	7.9	7.1	6.4	6.7	6.7	6.5						5.6	5.6	5.3	
24.0	6.3	7.0	7.8	8.4	8.6	7.2	8.1	9.0	8.9	8.3	7.9	8.7	7.7	6.9	6.3	6.7	6.7	6.3	5.7					5.6	5.6	5.1	
26.0	4.6	5.1	5.9	6.3		5.4	6.2	7.2	7.9	8.3	6.1	7.1	7.4	6.8	6.2	6.7	6.7	6.1	5.6	5.0			5.6	5.6	5.0	4.5	
28.0		3.6	4.2	4.6		3.9	4.6	5.5	6.1		4.6	5.5	6.7	6.6	6.2	5.5	6.5	5.9	5.5	5.0			5.6	5.5	4.8	4.4	3.9
30.0								4.0	4.6			4.1	5.2	5.9	6.1	4.2	5.1	5.7	5.3	4.9	4.8		4.8	5.3	4.7	4.3	3.8
32.0									3.2					3.9	4.5		3.9	5.0	5.2	4.9	3.6		4.7	4.5	4.2	3.8	
34.0														3.3				3.9	4.6				3.6	4.4	4.1	3.8	
36.0																		2.8	3.5				2.6	3.8	4.0	3.7	
38.0																								2.8	3.6		
40.0																										2.7	
(°)	63-84	62-84	64-84	65-84	69-84	63-84	65-84	65-84	64-84	69-84	65-84	65-84	65-84	65-84	69-84	64-84	65-84	64-84	66-84	69-84	64-84	63-84	64-84	65-84	65-84	69-84	
標準フック	25t										7.8t																
フック質量	450kg										300kg																
標準巻掛本数	2										1																

注)カウンタウエイト35t、アウトリガ張出幅 7.0m

F I 性能

5.5.0mブーム+1.85m+フルオートラフィングジブ

単位：t

ジブ長さ(m) 作業半径(m)	8.5					11.6					14.7					17.8					20.9					
	オフセット					オフセット					オフセット					オフセット					オフセット					
	5°	15°	30°	45°	60°	5°	15°	30°	45°	60°	5°	15°	30°	45°	60°	5°	15°	30°	45°	60°	5°	15°	30°	45°	60°	
11.0	11.5																									
12.0	11.5	11.5				10.0																				
14.0	11.5	11.5	11.4			10.0	10.0				6.9					6.7										
16.0	11.2	11.0	10.6	10.4	10.4	10.0	9.9	9.7			6.9					6.7							5.6			
18.0	10.5	10.2	9.9	9.7	9.7	9.6	9.5	9.1	8.9		6.9	6.9				6.7	6.7						5.6			
20.0	9.8	9.6	9.3	9.1	9.1	9.3	8.9	8.6	8.4	8.4	6.9	6.9	6.9			6.7	6.7						5.6	5.6		
22.0	8.8	9.0	8.7	8.6	8.6	8.7	8.4	8.1	8.0	8.0	6.9	6.9	6.9	6.9		6.7	6.7	6.3					5.6	5.6		
24.0	6.6	7.3	8.1	8.1	8.1	7.4	7.9	7.6	7.5	7.5	6.9	6.9	6.9	6.9	6.4	6.7	6.7	6.1	5.6				5.6	5.6	5.0	
26.0	4.8	5.4	6.1	6.6	6.9	5.6	6.4	7.2	7.1	7.1	6.6	6.9	6.7	6.6	6.3	6.6	6.5	5.9	5.5	5.1			5.6	5.6	4.8	
28.0		3.9	4.5	4.9		4.1	4.8	5.7	6.4	6.7	5.0	5.9	6.3	6.2	6.2	5.6	6.2	5.8	5.4	5.0			5.6	5.4	4.7	4.3
30.0								4.3	4.8		3.7	4.5	5.6	5.9	5.9	4.3	5.3	5.6	5.2	4.9	4.9	4.9	5.2	4.6	4.2	3.9
32.0									3.5			3.3	4.3	5.0	5.4		4.0	5.2	5.1	4.9	3.7		4.8	4.4	4.1	3.8
34.0													3.2	3.8			4.0	4.8	4.9		3.7		4.3	4.0	3.1	3.8
36.0																	3.0	3.7					3.9	4.0	3.7	
38.0																		2.7					2.9	3.7	3.7	
40.0																										2.8
(°)	65-84	64-84	66-84	67-84	69-84	65-84	66-84	66-84	66-84	69-84	65-84	65-84	65-84	67-84	69-84	66-84	66-84	65-84	65-84	69-84	66-84	66-84	66-84	66-84	66-84	69-84
標準フック	25t										7.8t															
フック質量	450kg										300kg															
標準巻掛本数	2										1															

注) カウンタウエイト35t、アウトリガ張出幅 7.0m

F I 性能

5.9.2mブーム+1.85m+フルオートラフィングジブ

単位：t

ジブ長さ(m) 作業半径(m)	8.5					11.6					14.7					17.8					20.9					
	オフセット					オフセット					オフセット					オフセット					オフセット					
	5°	15°	30°	45°	60°	5°	15°	30°	45°	60°	5°	15°	30°	45°	60°	5°	15°	30°	45°	60°	5°	15°	30°	45°	60°	
11.0	9.6																									
12.0	9.6	9.4				7.5																				
14.0	9.0	8.7	8.3			7.5	7.5				6.5					5.7										
16.0	8.4	8.3	7.7	7.5		7.5	7.4				6.5	6.5				5.7								5.0		
18.0	8.1	7.8	7.3	7.1	7.0	7.2	6.9	6.5			6.5	6.3				5.7	5.7							5.0		
20.0	7.5	7.3	6.9	6.7	6.6	7.0	6.5	6.1	5.9		6.3	6.0	5.5			5.7	5.5						5.0	5.0		
22.0	7.1	6.8	6.6	6.3	6.3	6.5	6.2	5.8	5.6	5.5	5.9	5.6	5.2	5.0		5.5	5.2	4.8					5.0	4.8		
24.0	6.6	6.4	6.2	6.0	6.0	6.1	5.9	5.5	5.3	5.3	5.7	5.3	5.0	4.8	4.7	5.2	4.9	4.6					4.8	4.5	4.2	
26.0	5.2	5.8	5.8	5.7	5.7	5.8	5.6	5.2	5.0	5.0	5.4	5.1	4.8	4.6	4.5	5.0	4.7	4.4	4.2				4.6	4.3	4.0	
28.0		4.2	4.9	5.3		4.7	5.2	5.0	4.8	4.8	5.1	4.8	4.5	4.4	4.3	4.8	4.4	4.2	4.0	3.9	4.3	4.1	3.8	3.6		
30.0				3.8			4.0	4.8	4.6		4.0	4.6	4.3	4.2	4.2	4.5	4.2	4.0	3.8	3.8	4.2	3.9	3.6	3.5		
32.0								3.6	4.1			3.6	4.1	4.0	4.0		4.0	3.8	3.7	3.6	3.9	3.7	3.5	3.3	3.3	
34.0													3.4	3.8			3.6	3.5	3.5		3.5		3.3	3.2	3.2	
36.0																	3.2	3.3					3.2	3.1	3.1	
38.0																			2.9				3.0	3.0	3.0	
40.0																										2.8
(°)	67-84	66-84	67-84	66-84	70-84	67-84	66-84	66-84	67-84	70-84	66-84	66-84	67-84	68-84	70-84	67-84	68-84	67-84	67-84	70-84	67-84	68-84	67-84	68-84	68-84	70-84
標準フック	25t										7.8t															
フック質量	450kg										300kg															
標準巻掛本数	2										1															

注) カウンタウエイト35t、アウトリガ張出幅 7.0m

F I 性能

6.3.4mブーム+1.85m+フルオートラフィングジブ

単位：t

ジブ長さ(m) 作業半径(m)	8.5					11.6					14.7					17.8					20.9						
	オフセット					オフセット					オフセット					オフセット					オフセット						
	5°	15°	30°	45°	60°	5°	15°	30°	45°	60°	5°	15°	30°	45°	60°	5°	15°	30°	45°	60°	5°	15°	30°	45°	60°		
14.0	7.0	7.0				6.1					5.4																
16.0	6.8	6.6	6.3			6.1	6.0				5.4					4.7											
18.0	6.3	6.1	5.9	5.7		5.9	5.7	5.3			5.4	5.2				4.7							4.2				
20.0	6.0	5.8	5.5	5.3	5.3	5.5	5.3	5.0	4.8		5.2	4.9				4.7	4.5						4.2				
22.0	5.6	5.4	5.1	5.0	5.0	5.2	5.0	4.7	4.5	4.5	4.8	4.6	4.3			4.6	4.3						4.2	4.0			
24.0	5.3	5.1	4.8	4.7	4.7	4.9	4.7	4.4	4.3	4.2	4.5	4.3	4.1	3.9		4.3	4.0	3.8					4.0	3.7			
26.0	4.9	4.8	4.6	4.4	4.4	4.6	4.4	4.2	4.1	4.0	4.3	4.1	3.9	3.7	3.7	4.0	3.8	3.6					3.8	3.5	3.3		
28.0	4.3	4.5	4.3	4.2	4.2	4.3	4.1	3.9	3.9	3.8	4.0	3.8	3.6	3.5	3.5	3.8	3.6	3.4	3.3	3.2			3.6	3.4	3.1		
30.0			4.0	4.0			3.9	3.7	3.6	3.6	3.8	3.6	3.5	3.3	3.3	3.6	3.4	3.2	3.1	3.1	3.3	3.2	3.0	2.9			
32.0								3.5	3.4			3.4	3.3	3.2	3.2		3.2	3.0	2.9	2.9	3.2	3.0	2.8	2.7	2.7		
34.0													3.1	3.0	3.0			2.9	2.8	2.8		2.9	2.7	2.6	2.6		
36.0																	2.7	2.7	2.6				2.6	2.5	2.4		
38.0																			2.5				2.4	2.3	2.3		
40.0																										2.2	2.2
(°)	67-84	68-84	67-84	68-84	70-84	68-84	68-84	68-84	69-84	70-84	68-84	68-84	68-84	68-84	70-84	69-84	68-84	68-84	68-84	70-84	68-84	69-84	69-84	69-84	69-84	70-84	
標準フック											7.8t																
フック質量											300kg																
標準巻掛本数											1																

注) カウンタウエイト35t、アウトリガ張出幅 7.0m

F J 性能

30.0mブーム+1.85m+フルオートラフィングジブ

単位：t

ジブ長さ(m)	8.5					11.6					14.7					17.8					20.9				
	オフセット					オフセット					オフセット					オフセット					オフセット				
	5°	15°	30°	45°	60°	5°	15°	30°	45°	60°	5°	15°	30°	45°	60°	5°	15°	30°	45°	60°	5°	15°	30°	45°	60°
7.0	26.1	20.9				14.6					13.9														
8.0	24.4	19.9				14.6	14.6				13.9					13.5									
9.0	22.8	19.0	15.8			14.6	14.6				13.9					13.4					5.6				
10.0	21.5	18.2	15.3	13.6		14.6	14.5				13.9	12.4				13.0					5.6				
11.0	20.3	17.4	14.9	13.3	12.2	14.6	13.8	11.5			13.9	11.8				12.5	10.2				5.6				
12.0	19.2	16.7	14.5	13.1	12.1	14.6	13.2	11.2			13.4	11.3				11.7	9.8				5.6				
14.0	16.7	15.5	13.8	12.7	11.9	13.9	12.2	10.6	9.5	8.6	12.0	10.3	8.8			10.4	8.9				5.6	5.6			
16.0	12.2	13.1	13.2	12.4	11.8	12.6	11.3	10.0	9.2	8.5	10.8	9.5	8.3	7.4		9.3	8.2	7.0			5.6	5.6			
18.0	8.8	9.7	10.6	11.2	11.5	10.2	10.5	9.6	8.9	8.4	9.8	8.8	7.8	7.1	6.5	8.4	7.6	6.6	5.8		5.6	5.6	5.6		
20.0	6.0	6.8	7.7	8.3		7.5	8.5	9.1	8.7	8.3	8.6	8.2	7.5	6.9	6.4	7.7	7.0	6.3	5.6	5.0	5.6	5.6	5.6		
22.0	3.8	4.4	5.2	5.6		5.2	6.1	7.3	8.0	8.3	6.4	7.5	7.1	6.7	6.3	7.0	6.5	6.0	5.4	4.9	5.6	5.6	5.3	4.6	
24.0			3.2	3.5		3.4	4.2	5.1	5.8		4.5	5.5	6.8	6.5	6.3	5.4	6.1	5.7	5.3	4.8	5.6	5.5	5.0	4.5	4.0
26.0							2.6	3.4	3.8		3.0	3.8	4.9	5.7		3.8	4.9	5.4	5.1	4.8	4.9	5.2	4.8	4.3	3.9
28.0								1.9	2.2			2.4	3.4	4.0		2.5	3.5	4.6	5.0		3.6	4.7	4.6	4.2	3.9
30.0													2.0	2.5			2.2	3.3	4.0		2.5	3.4	4.4	4.1	3.8
32.0																		2.1	2.6			2.4	3.5	4.0	
34.0																							2.4	3.1	
36.0																							1.4	2.0	
(°)	54~84	56~84	54~84	55~84	65~84	54~84	53~84	52~84	53~84	65~84	54~84	54~84	54~84	55~84	66~84	54~84	54~84	55~84	57~84	67~84	55~84	55~84	53~84	56~84	68~84
標準フック	80t					25t										7.8t									
フック質量	1150kg					450kg										300kg									
標準巻掛本数	4					2										1									

注) カウンタウエイト23.5t、アウトリガ張出幅 7.0m

F J 性能

34.1mブーム+1.85m+フルオートラフィングジブ

単位：t

ジブ長さ(m)	8.5					11.6					14.7					17.8					20.9				
	オフセット					オフセット					オフセット					オフセット					オフセット				
	5°	15°	30°	45°	60°	5°	15°	30°	45°	60°	5°	15°	30°	45°	60°	5°	15°	30°	45°	60°	5°	15°	30°	45°	60°
7.0	27.5	21.5				14.6																			
8.0	25.8	20.5				14.6					13.9					13.5									
9.0	24.2	19.7	16.0			14.6	14.6				13.9					13.2									
10.0	22.8	18.8	15.6			14.6	14.6				13.9	12.8				12.8									
11.0	21.6	18.1	15.2	13.4		14.6	14.6	11.9			13.9	12.2				12.4	10.5				5.6				
12.0	20.5	17.4	14.8	13.2	12.1	14.6	14.1	11.6			13.9	11.7				12.0	10.0				5.6				
14.0	16.6	16.2	14.1	12.8	11.9	14.6	13.0	11.0	9.7		12.8	10.7	8.9			11.0	9.2				5.6	5.6			
16.0	12.1	13.1	13.5	12.5	11.8	13.4	12.1	10.4	9.4	8.6	11.5	9.9	8.4	7.4		9.9	8.5	7.1			5.6	5.6			
18.0	8.7	9.7	10.6	11.3	11.7	10.1	11.1	10.0	9.1	8.4	10.4	9.2	8.0	7.2	6.5	9.0	7.8	6.7			5.6	5.6	5.6		
20.0	5.9	6.7	7.8	8.4	8.6	7.4	8.5	9.5	8.9	8.4	8.4	8.6	7.6	6.9	6.4	8.2	7.3	6.4	5.6		5.6	5.6	5.6		
22.0		4.4	5.3	5.8		5.1	6.1	7.3	8.1	8.3	6.2	7.4	7.3	6.7	6.3	7.0	6.8	6.1	5.5	4.9	5.6	5.6	5.4	4.6	
24.0						3.3	4.1	5.2	5.9		4.3	5.4	6.7	6.6	6.2	5.1	6.4	5.8	5.3	4.8	5.6	5.6	5.1	4.5	3.9
26.0								3.4	4.0		2.8	3.7	4.9	5.8	6.2	3.6	4.7	5.6	5.2	4.7	4.7	5.4	4.9	4.3	3.9
28.0										2.4			3.4	4.1			3.3	4.6	5.0	4.7	3.4	4.5	4.7	4.2	3.8
30.0														2.6				3.2	4.0		2.2	3.3	4.5	4.1	3.8
32.0																			2.7			2.2	3.4	4.0	
34.0																							2.3	3.1	
36.0																								2.0	
(°)	61~84	60~84	62~84	63~84	66~84	58~84	60~84	60~84	58~84	66~84	58~84	60~84	61~84	59~84	66~84	60~84	60~84	61~84	61~84	67~84	58~84	59~84	60~84	60~84	68~84
標準フック	80t					25t										7.8t									
フック質量	1150kg					450kg										300kg									
標準巻掛本数	4					2										1									

注) カウンタウエイト23.5t、アウトリガ張出幅 7.0m

F J 性能

38.3mブーム+1.85m+フルオートラフィングジブ

単位：t

ジブ長さ(m)	8.5					11.6					14.7					17.8					20.9				
	オフセット					オフセット					オフセット					オフセット					オフセット				
	5°	15°	30°	45°	60°	5°	15°	30°	45°	60°	5°	15°	30°	45°	60°	5°	15°	30°	45°	60°	5°	15°	30°	45°	60°
7.0	25.0																								
8.0	25.0	21.6				14.6																			
9.0	25.0	20.7				14.6					13.9				12.9										
10.0	24.7	19.9	16.1			14.6	14.6				13.9				12.6										
11.0	23.4	19.1	15.7			14.6	14.6				13.9	12.6			12.2						5.6				
12.0	22.2	18.4	15.3	13.5	12.2	14.6	14.6	11.8			13.9	12.1			11.8	10.1					5.6				
14.0	16.7	17.2	14.6	13.1	12.1	14.6	13.6	11.2	9.8		13.6	11.1	9.1		11.1	9.5					5.6				
16.0	12.2	13.2	14.0	12.8	11.9	13.3	12.6	10.7	9.5	8.6	12.3	10.3	8.6		10.6	8.8	7.2				5.6	5.6			
18.0	8.8	9.8	10.8	11.5	11.8	10.0	11.1	10.2	9.2	8.5	10.9	9.6	8.2	7.3	9.6	8.2	6.9				5.6	5.6			
20.0	6.0	6.8	7.9	8.6	8.9	7.3	8.4	9.6	9.0	8.4	8.3	9.0	7.8	7.0	6.4	8.8	7.6	6.5	5.7		5.6	5.6	5.6		
22.0		4.5	5.4	6.0		5.0	6.0	7.3	8.1	8.3	6.0	7.2	7.5	6.8	6.3	6.8	7.1	6.2	5.5	4.9	5.6	5.6	5.5		
24.0				3.9			4.1	5.2	6.0	6.3	4.1	5.2	6.7	6.7	6.2	4.9	6.2	6.0	5.4	4.8	5.6	5.6	5.3	4.5	
26.0								3.4	4.1			3.6	4.8	5.8	6.2	3.4	4.5	5.7	5.2	4.8	4.4	5.6	5.0	4.4	3.9
28.0													3.3	4.1			4.5	5.1	4.7	3.1	4.3	4.8	4.3	3.8	
30.0																	3.1	4.0			3.1	4.5	4.2	3.8	
32.0																		2.7				3.3	4.1	3.8	
34.0																								3.1	
(°)	64~84	63~84	65~84	63~84	67~84	63~84	63~84	63~84	64~84	67~84	63~84	63~84	63~84	65~84	67~84	62~84	65~84	64~84	64~84	68~84	63~84	63~84	65~84	66~84	68~84
標準フック	80t					25t					7.8t														
フック質量	1150kg					450kg					300kg														
標準巻掛本数	4					2					1														

注) カウンタウエイト23.5t、アウトリガ張出幅 7.0m

F J 性能

42.5mブーム+1.85m+フルオートラフィングジブ

単位：t

ジブ長さ(m)	8.5					11.6					14.7					17.8					20.9				
	オフセット					オフセット					オフセット					オフセット					オフセット				
	5°	15°	30°	45°	60°	5°	15°	30°	45°	60°	5°	15°	30°	45°	60°	5°	15°	30°	45°	60°	5°	15°	30°	45°	60°
8.0	21.3																								
9.0	21.3	21.3				14.6																			
10.0	21.3	20.5				14.6					13.9				11.5										
11.0	21.3	19.7	15.9			14.6	14.6				13.9				11.5										
12.0	21.0	19.0	15.6	13.6		14.6	14.6				13.8	12.0			11.5						5.6				
14.0	16.9	17.8	14.9	13.3	12.1	14.6	14.1	11.4			13.1	11.4			10.8	9.4					5.6				
16.0	12.4	13.3	14.3	12.9	12.0	13.5	13.1	10.9	9.6	8.6	12.4	10.7	8.8		10.2	8.9					5.6	5.6			
18.0	9.0	9.9	11.0	11.7	11.8	10.1	11.2	10.5	9.4	8.5	10.9	10.0	8.4	7.3	9.8	8.5	7.0				5.6	5.6			
20.0	6.2	7.1	8.1	8.8	9.1	7.4	8.5	9.8	9.1	8.4	8.3	9.4	8.0	7.1	6.4	9.0	7.9	6.7	5.8		5.6	5.6	5.6		
22.0		4.7	5.7	6.3	6.6	5.1	6.1	7.5	8.3	8.3	6.0	7.3	7.7	6.9	6.3	6.8	7.4	6.4	5.6	4.9	5.6	5.6	5.5		
24.0				4.2			4.2	5.3	6.2	6.6	4.2	5.3	6.8	6.8	6.3	4.9	6.2	6.1	5.4	4.8	5.6	5.6	5.3	4.6	
26.0								4.3	4.6				5.0	6.0	6.2		4.6	5.9	5.3	4.8	4.4	5.6	5.1	4.4	3.9
28.0													4.3	4.7			4.6	5.2	4.7		4.3	4.9	4.3	3.9	
30.0																		4.2	4.7			4.6	4.2	3.8	
32.0																						3.4	4.1	3.8	
34.0																								3.2	3.7
(°)	66~84	65~84	67~84	65~84	67~84	66~84	65~84	67~84	67~84	67~84	65~84	67~84	68~84	68~84	67~84	67~84	67~84	68~84	69~84	68~84	66~84	67~84	67~84	68~84	68~84
標準フック	25t					25t					7.8t														
フック質量	450kg					450kg					300kg														
標準巻掛本数	3					2					1														

注) カウンタウエイト23.5t、アウトリガ張出幅 7.0m

F J 性能

4.6.7mブーム+1.85m+フルオートラフィングジブ

単位：t

ジブ長さ(m)	8.5					11.6					14.7					17.8					20.9					
	オフセット					オフセット					オフセット					オフセット					オフセット					
	5°	15°	30°	45°	60°	5°	15°	30°	45°	60°	5°	15°	30°	45°	60°	5°	15°	30°	45°	60°	5°	15°	30°	45°	60°	
9.0	17.5																									
10.0	17.5	17.5				14.2																				
11.0	17.5	17.5				14.2					12.0					10.1										
12.0	17.5	17.5	15.8			14.2	14.2				12.0					10.1										
14.0	16.9	16.4	15.2	13.4		14.2	14.0	11.6			12.0	11.1				10.1	9.1						5.6			
16.0	12.6	13.5	14.6	13.1	12.0	13.6	13.6	11.1	9.7		12.0	10.6	8.9			9.9	8.7						5.6			
18.0	9.2	10.1	11.1	11.9	11.9	10.2	11.3	10.7	9.5	8.5	11.0	10.2	8.5			9.4	8.3	7.0					5.6	5.6		
20.0	6.4	7.2	8.3	9.0	9.4	7.5	8.7	9.9	9.2	8.4	8.4	9.6	8.2	7.2	6.4	9.0	8.0	6.8					5.6	5.6		
22.0			5.9	6.5	6.8	5.3	6.3	7.6	8.4	8.4	6.1	7.4	7.9	7.0	6.4	6.8	7.6	6.5	5.6				5.6	5.6	5.4	
24.0								5.5	6.4	6.8		5.4	6.9	6.8	6.3	5.0	6.3	6.2	5.5	4.8			5.6	5.6	5.2	
26.0									4.5	4.9			5.1	6.1	6.2		4.6	6.0	5.4	4.8	4.4		5.6	5.1	4.5	
28.0														4.4	4.9			4.6	5.2	4.7			4.3	4.9	4.4	3.9
30.0																			4.3	4.7				4.6	4.3	3.8
32.0																				3.5					4.2	3.8
34.0																									3.3	3.7
(°)	68-84	69-84	69-84	70-84	68-84	67-84	69-84	69-84	69-84	68-84	69-84	69-84	70-84	69-84	71-84	68-84	69-84	70-84	70-84	69-84	68-84	69-84	69-84	69-84	69-84	
標準フック	25t					25t										7.8t										
フック質量	450kg					450kg										300kg										
標準巻掛本数	3					2										1										

注) カウンタウエイト23.5t、アウトリガ張出幅 7.0m

F J 性能

5.0.9mブーム+1.85m+フルオートラフィングジブ

単位：t

ジブ長さ(m)	8.5					11.6					14.7					17.8					20.9					
	オフセット					オフセット					オフセット					オフセット					オフセット					
	5°	15°	30°	45°	60°	5°	15°	30°	45°	60°	5°	15°	30°	45°	60°	5°	15°	30°	45°	60°	5°	15°	30°	45°	60°	
10.0	13.8																									
11.0	13.8	13.8				11.8																				
12.0	13.8	13.8				11.8					10.1															
14.0	13.8	13.8	13.3	13.0		11.8	11.8				10.1	10.1				6.7										
16.0	13.0	13.0	12.5	12.2	12.1	11.8	11.8	11.3			10.1	10.0				6.7							5.6			
18.0	9.7	10.5	11.5	11.5	11.4	10.5	11.2	10.7	9.5		10.1	9.6	8.4			6.7	6.7						5.6	5.6		
20.0	6.9	7.7	8.8	9.4	9.8	7.8	8.9	10.1	9.3	8.5	8.6	9.5	8.2	7.3		6.7	6.7	6.7					5.6	5.6		
22.0			6.3	7.0	7.3		6.5	7.8	8.6	8.4	6.3	7.6	7.9	7.1	6.4	6.7	6.7	6.5					5.6	5.6	5.3	
24.0					5.2			5.7	6.6	7.1		5.6	7.0	6.9	6.3	5.4	6.7	6.3	5.7				5.6	5.6	5.1	
26.0									4.8	5.2			5.3	6.3	6.2		5.0	6.1	5.6	5.0	4.5		5.6	5.0	4.5	
28.0														4.6	5.2			5.0	5.5	5.0			4.4	4.8	4.4	3.9
30.0																			4.7	4.9				4.7	4.3	3.8
32.0																				3.9					4.2	3.8
34.0																									3.5	3.8
(°)	70-84	71-84	70-84	71-84	70-84	71-84	71-84	71-84	70-84	71-84	70-84	70-84	71-84	71-84	72-84	70-84	70-84	71-84	72-84	71-84	69-84	70-84	72-84	71-84	72-84	
標準フック	25t										7.8t															
フック質量	450kg										300kg															
標準巻掛本数	2										1															

注) カウンタウエイト23.5t、アウトリガ張出幅 7.0m

F J 性能

55.0mブーム+1.85m+フルオートラフィングジブ

単位：t

ジブ長さ(m)	8.5					11.6					14.7					17.8					20.9				
	オフセット					オフセット					オフセット					オフセット					オフセット				
	5°	15°	30°	45°	60°	5°	15°	30°	45°	60°	5°	15°	30°	45°	60°	5°	15°	30°	45°	60°	5°	15°	30°	45°	60°
11.0	11.5																								
12.0	11.5	11.5				10.0																			
14.0	11.5	11.5	11.4			10.0	10.0				6.9				6.7										
16.0	11.2	11.0	10.6	10.4	10.4	10.0	9.9	9.7			6.9				6.7								5.6		
18.0	9.9	10.2	9.9	9.7	9.7	9.6	9.5	9.1	8.9		6.9	6.9			6.7	6.7							5.6		
20.0	7.1	8.0	9.0	9.1	9.1	8.0	8.9	8.6	8.4	8.4	6.9	6.9	6.9		6.7	6.7							5.6	5.6	
22.0			6.6	7.3	7.7		6.7	8.0	8.0	8.0	6.8	6.9	6.9	6.9	6.7	6.7	6.3						5.6	5.6	
24.0					5.5			6.0	6.8	7.3		6.0	6.9	6.9	6.4	5.5	6.7	6.1	5.6				5.6	5.6	5.0
26.0									5.0	5.4			5.7	6.6	6.3		5.2	5.9	5.5	5.1			5.6	4.8	
28.0														5.1	5.7			5.2	5.4	5.0			4.5	4.7	4.3
30.0															4.2				4.9	4.9			4.6	4.2	3.9
32.0																				4.1				4.1	3.8
34.0																								3.6	3.8
(°)	71-84	72-84	72-84	73-84	71-84	72-84	72-84	72-84	72-84	72-84	72-84	72-84	73-84	73-84	72-84	71-84	71-84	73-84	73-84	72-84	72-84	71-84	73-84	72-84	74-84
標準フック	25t										7.8t														
フック質量	450kg										300kg														
標準巻掛本数	2										1														

注) カウンタウエイト23.5t、アウトリガ張出幅 7.0m

F J 性能

59.2mブーム+1.85m+フルオートラフィングジブ

単位：t

ジブ長さ(m)	8.5					11.6					14.7					17.8					20.9					
	オフセット					オフセット					オフセット					オフセット					オフセット					
	5°	15°	30°	45°	60°	5°	15°	30°	45°	60°	5°	15°	30°	45°	60°	5°	15°	30°	45°	60°	5°	15°	30°	45°	60°	
11.0	9.6																									
12.0	9.6	9.4				7.5																				
14.0	9.0	8.7	8.3			7.5	7.5				6.5				5.7											
16.0	8.4	8.3	7.7	7.5		7.5	7.4				6.5	6.5			5.7								5.0			
18.0	8.1	7.8	7.3	7.1	7.0	7.2	6.9	6.5			6.5	6.3			5.7	5.7							5.0			
20.0	7.5	7.3	6.9	6.7	6.6	7.0	6.5	6.1	5.9		6.3	6.0	5.5		5.7	5.5							5.0	5.0		
22.0			6.6	6.3	6.3	6.4	6.2	5.8	5.6	5.5	5.9	5.6	5.2	5.0		5.5	5.2	4.8					5.0	4.8		
24.0					5.8			5.5	5.3	5.3		5.3	5.0	4.8	4.7	5.2	4.9	4.6					4.8	4.5	4.2	
26.0									5.0	5.0			4.8	4.6	4.5		4.7	4.4	4.2				4.3	4.0		
28.0														4.4	4.3			4.2	4.0	3.9				3.8	3.6	
30.0															4.2				3.8	3.8				3.6	3.5	
32.0																				3.6					3.3	3.3
34.0																									3.2	3.2
(°)	72-84	73-84	73-84	74-84	73-84	72-84	73-84	73-84	73-84	74-84	73-84	73-84	74-84	74-84	73-84	72-84	73-84	74-84	74-84	74-84	73-84	73-84	74-84	73-84	75-84	
標準フック	25t										7.8t															
フック質量	450kg										300kg															
標準巻掛本数	2										1															

注) カウンタウエイト23.5t、アウトリガ張出幅 7.0m

F J 性能

63.4mブーム+1.85m+フルオートラフィングジブ

単位：t

ジブ長さ(m)	8.5					11.6					14.7					17.8					20.9					
	オフセット					オフセット					オフセット					オフセット					オフセット					
	5°	15°	30°	45°	60°	5°	15°	30°	45°	60°	5°	15°	30°	45°	60°	5°	15°	30°	45°	60°	5°	15°	30°	45°	60°	
14.0	7.0	7.0				6.1					5.4															
16.0	6.8	6.6	6.3			6.1	6.0				5.4					4.7										
18.0	6.3	6.1	5.9	5.7		5.9	5.7	5.3			5.4	5.2				4.7							4.2			
20.0	6.0	5.8	5.5	5.3	5.3	5.5	5.3	5.0	4.8		5.2	4.9				4.7	4.5						4.2			
22.0			5.4	5.1	5.0	5.2	5.0	4.7	4.5	4.5	4.8	4.6	4.3			4.6	4.3						4.2	4.0		
24.0				4.7	4.7				4.4	4.3	4.2		4.3	4.1	3.9		4.3	4.0	3.8				4.0	3.7		
26.0									4.1	4.0			3.9	3.7	3.7		3.8	3.6					3.5	3.3		
28.0													3.5	3.5			3.4	3.3	3.2					3.1		
30.0														3.3				3.1	3.1					3.0	2.9	
32.0																			2.9						2.7	2.7
34.0																									2.6	
(°)	73-84	73-84	74-84	73-84	74-84	73-84	74-84	74-84	74-84	75-84	74-84	74-84	75-84	75-84	74-84	73-84	73-84	75-84	75-84	75-84	74-84	75-84	75-84	76-84	76-84	
標準フック											7.8t															
フック質量											300kg															
標準巻掛本数											1															

注) カウンタウエイト23.5t、アウトリガ張出幅 7.0m

F K性能

30.0mブーム+1.85m+フルオートラフィングジブ

単位：t

ジブ長さ(m) 作業半径(m)	8.5					11.6					14.7					17.8					20.9				
	オフセット					オフセット					オフセット					オフセット					オフセット				
	5°	15°	30°	45°	60°	5°	15°	30°	45°	60°	5°	15°	30°	45°	60°	5°	15°	30°	45°	60°	5°	15°	30°	45°	60°
7.0	26.1	20.9				14.6					13.9														
8.0	24.4	19.9				14.6	14.6				13.9					13.5									
9.0	22.8	19.0	15.8			14.6	14.6				13.9					13.4					5.6				
10.0	21.5	18.2	15.3	13.6		14.6	14.5				13.9	12.4				13.0					5.6				
11.0	19.3	17.4	14.9	13.3	12.2	14.6	13.8	11.5			13.9	11.8				12.5	10.2				5.6				
12.0	15.7	16.7	14.5	13.1	12.1	14.6	13.2	11.2			13.4	11.3				11.7	9.8				5.6				
14.0	10.5	11.6	13.1	12.7	11.9	12.0	12.2	10.6	9.5	8.6	12.0	10.3	8.8			10.4	8.9				5.6	5.6			
16.0	6.8	7.9	9.1	9.9	10.3	8.4	9.6	10.0	9.2	8.5	9.4	9.5	8.3	7.4		9.3	8.2	7.0			5.6	5.6			
18.0			5.9	6.7	7.1	5.4	6.7	8.1	8.9	8.4	6.6	8.0	7.8	7.1	6.5	7.5	7.6	6.6	5.8		5.6	5.6	5.6		
20.0							4.2	5.6	6.5	7.0	4.3	5.6	7.2	6.9	6.4	5.2	6.7	6.3	5.6	5.0	5.6	5.6	5.6		
22.0									4.2	4.6		3.6	5.1	6.2	6.3	4.7	6.0	5.4	4.9	4.6	5.6	5.3	4.6		
24.0													3.3	4.3	4.8		4.7	5.3	4.8		4.4	5.0	4.5	4.0	
26.0																	3.1	4.1	4.7		3.0	4.6	4.3	3.9	
28.0																						3.2	4.2	3.9	
30.0																							3.0	3.6	
(°)	65-84	66-84	65-84	67-84	65-84	64-84	63-84	66-84	65-84	65-84	63-84	63-84	64-84	66-84	66-84	65-84	66-84	64-84	68-84	67-84	65-84	64-84	66-84	66-84	68-84
標準フック	80 t										25t										7.8t				
フック質量	1150kg										450kg										300kg				
標準巻掛本数	4										2										1				

注)カウンタウエイト12t、アウトリガ張出幅 7.0m

F K性能

34.1mブーム+1.85m+フルオートラフィングジブ

単位：t

ジブ長さ(m) 作業半径(m)	8.5					11.6					14.7					17.8					20.9				
	オフセット					オフセット					オフセット					オフセット					オフセット				
	5°	15°	30°	45°	60°	5°	15°	30°	45°	60°	5°	15°	30°	45°	60°	5°	15°	30°	45°	60°	5°	15°	30°	45°	60°
7.0	27.5	21.5				14.6																			
8.0	25.8	20.5				14.6					13.9					13.5									
9.0	24.2	19.7	16.0			14.6	14.6				13.9					13.2									
10.0	22.8	18.8	15.6			14.6	14.6				13.9	12.8				12.8									
11.0	19.3	18.1	15.2	13.4		14.6	14.6	11.9			13.9	12.2				12.4	10.5				5.6				
12.0	15.6	17.1	14.8	13.2	12.1	14.6	14.1	11.6			13.9	11.7				12.0	10.0				5.6				
14.0	10.5	11.6	13.1	12.8	11.9	11.9	13.0	11.0	9.7		12.8	10.7	8.9			11.0	9.2				5.6	5.6			
16.0		7.8	9.1	10.0	10.5	8.3	9.5	10.4	9.4	8.6	9.2	9.9	8.4	7.4		9.9	8.5	7.1			5.6	5.6			
18.0				6.8	7.2	5.3	6.6	8.1	9.1	8.4	6.4	7.8	8.0	7.2	6.5	7.3	7.8	6.7			5.6	5.6	5.6		
20.0								5.6	6.6	7.1		5.5	7.1	6.9	6.4	5.0	6.5	6.4	5.6		5.6	5.6	5.6		
22.0									4.3	4.7			5.1	6.2	6.3	4.5	6.1	5.5	4.9	4.3	5.6	5.4	4.6		
24.0														4.3	4.9		4.5	5.3	4.8		4.2	5.1	4.5	3.9	
26.0																		4.1	4.7			4.5	4.3	3.9	
28.0																							4.2	3.8	
30.0																							3.0	3.7	
(°)	70-84	69-84	71-84	69-84	70-84	66-84	69-84	69-84	68-84	69-84	68-84	68-84	69-84	69-84	70-84	67-84	68-84	69-84	70-84	72-84	67-84	68-84	70-84	69-84	71-84
標準フック	80 t										25t										7.8t				
フック質量	1150kg										450kg										300kg				
標準巻掛本数	4										2										1				

注)カウンタウエイト12t、アウトリガ張出幅 7.0m

F K性能

38.3mブーム+1.85m+フルオートラフィングジブ

単位：t

ジブ長さ(m) 作業半径(m)	8.5					11.6					14.7					17.8					20.9				
	オフセット					オフセット					オフセット					オフセット					オフセット				
	5°	15°	30°	45°	60°	5°	15°	30°	45°	60°	5°	15°	30°	45°	60°	5°	15°	30°	45°	60°	5°	15°	30°	45°	60°
7.0	25.0					14.6																			
8.0	25.0	21.6				14.6																			
9.0	25.0	20.7				14.6					13.9					12.9									
10.0	24.1	19.9	16.1			14.6	14.6				13.9					12.6									
11.0	19.4	19.1	15.7			14.6	14.6				13.9	12.6				12.2					5.6				
12.0	15.7	17.2	15.3	13.5	12.2	14.6	14.6	11.8			13.9	12.1				11.8	10.1				5.6				
14.0	10.6	11.7	13.3	13.1	12.1	11.8	13.3	11.2	9.8		12.8	11.1	9.1			11.1	9.5				5.6				
16.0		7.9	9.2	10.2	10.7	8.1	9.5	10.7	9.5	8.6	9.1	10.3	8.6			9.8	8.8	7.2			5.6	5.6			
18.0			6.1	7.0	7.4		6.5	8.1	9.2	8.5		7.7	8.2	7.3		7.1	8.2	6.9			5.6	5.6			
20.0								5.6	6.6	7.2			7.1	7.0	6.4		6.4	6.5	5.7		5.6	5.6	5.6		
22.0									4.9				5.0	6.2	6.3			6.2	5.5	4.9		5.6	5.5		
24.0														5.0					5.4	4.8			5.3	4.5	
26.0																			4.1	4.8			4.4	4.4	3.9
28.0																							4.3	3.8	
30.0																								3.7	
(°)	72-84	71-84	70-84	71-84	72-84	71-84	70-84	71-84	73-84	71-84	72-84	72-84	71-84	73-84	72-84	71-84	72-84	74-84	72-84	73-84	71-84	72-84	72-84	73-84	73-84
標準フック	80 t										25t										7.8t				
フック質量	1150kg										450kg										300kg				
標準巻掛本数	4										2										1				

注)カウンタウエイト12t、アウトリガ張出幅 7.0m

F K性能

4.2. 5mブーム+1.85m+フルオートラフィングジブ

単位：t

ジブ長さ(m)	8.5					11.6					14.7					17.8					20.9						
	オフセット					オフセット					オフセット					オフセット					オフセット						
	5°	15°	30°	45°	60°	5°	15°	30°	45°	60°	5°	15°	30°	45°	60°	5°	15°	30°	45°	60°	5°	15°	30°	45°	60°		
8.0	21.3																										
9.0	21.3	21.3				14.6																					
10.0	21.3	20.5				14.6					13.9					11.5											
11.0	19.6	19.7	15.9			14.6	14.6				13.9					11.5											
12.0	15.9	17.4	15.6	13.6		14.6	14.6				13.8	12.0				11.5						5.6					
14.0	10.8	11.9	13.4	13.3	12.1	11.9	13.5	11.4			12.8	11.4				10.8	9.4					5.6					
16.0		8.2	9.4	10.4	10.9	8.3	9.6	10.9	9.6	8.6	9.1	10.7	8.8			9.8	8.9					5.6	5.6				
18.0				7.3	7.7			8.2	9.3	8.5		7.8	8.4	7.3		7.1	8.5	7.0				5.6	5.6				
20.0									6.8	7.4				7.2	7.1	6.4						5.6	5.6				
22.0															6.3	6.3					6.3	5.6	4.9	5.6	5.5		
24.0																						5.4	4.8		5.3	4.6	
26.0																							4.8		4.4	4.4	3.9
28.0																										4.3	3.9
30.0																											3.8
(°)	73-84	72-84	74-84	73-84	74-84	72-84	74-84	74-84	74-84	75-84	74-84	74-84	75-84	75-84	74-84	73-84	73-84	75-84	75-84	75-84	74-84	73-84	73-84	74-84	74-84	74-84	
標準フック	25t					25t					25t					7.8t											
フック質量	450kg					450kg					450kg					300kg											
標準巻掛本数	3					2					1																

注) カウンタウエイト12t、アウトリガ張出幅 7.0m

F K性能

4.6. 7mブーム+1.85m+フルオートラフィングジブ

単位：t

ジブ長さ(m)	8.5					11.6					14.7					17.8					20.9						
	オフセット					オフセット					オフセット					オフセット					オフセット						
	5°	15°	30°	45°	60°	5°	15°	30°	45°	60°	5°	15°	30°	45°	60°	5°	15°	30°	45°	60°	5°	15°	30°	45°	60°		
9.0	17.5																										
10.0	17.5	17.5				14.2																					
11.0	17.5	17.5				14.2					12.0					10.1											
12.0	16.1	17.5	15.8			14.2	14.2				12.0					10.1											
14.0	10.9	12.1	13.6	13.4		12.0	13.6	11.6			12.0	11.1				10.1	9.1							5.6			
16.0			9.6	10.5	11.1		9.7	11.1	9.7		9.2	10.6	8.9			9.9	8.7							5.6			
18.0				7.5	7.9			8.3	9.5	8.5		7.9	8.5			8.3	7.0							5.6	5.6		
20.0									6.9	7.5				7.2	7.2	6.4								5.6			
22.0															6.4	6.4									5.4		
24.0																									5.2		
26.0																										4.5	
28.0																										4.4	3.9
(°)	75-84	76-84	75-84	75-84	75-84	76-84	75-84	76-84	75-84	76-84	75-84	75-84	76-84	76-84	78-84	76-84	76-84	77-84	76-84	75-84	76-84	76-84	76-84	76-84	76-84	78-84	78-84
標準フック	25t					25t					25t					7.8t											
フック質量	450kg					450kg					450kg					300kg											
標準巻掛本数	3					2					1																

注) カウンタウエイト12t、アウトリガ張出幅 7.0m

F K性能

5.0. 9mブーム+1.85m+フルオートラフィングジブ

単位：t

ジブ長さ(m)	8.5					11.6					14.7					17.8					20.9						
	オフセット					オフセット					オフセット					オフセット					オフセット						
	5°	15°	30°	45°	60°	5°	15°	30°	45°	60°	5°	15°	30°	45°	60°	5°	15°	30°	45°	60°	5°	15°	30°	45°	60°		
10.0	13.8																										
11.0	13.8	13.8				11.8																					
12.0	13.8	13.8				11.8					10.1																
14.0	11.4	12.5	13.3	13.0		11.8	11.8				10.1	10.1				6.7											
16.0			10.0	10.9	11.5		9.9	11.3			9.4	10.0				6.7								5.6			
18.0				7.8	8.3			8.5	9.5			8.0	8.4				6.7							5.6	5.6		
20.0									7.1	7.8				7.4	7.3									5.6			
22.0															6.5	6.4											
24.0																									5.3		
26.0																									5.1		
28.0																										4.5	
(°)	76-84	77-84	77-84	76-84	76-84	77-84	76-84	77-84	76-84	77-84	76-84	76-84	77-84	77-84	78-84	77-84	77-84	77-84	78-84	77-84	76-84	77-84	77-84	77-84	78-84	79-84	
標準フック	25t					25t					25t					7.8t											
フック質量	450kg					450kg					450kg					300kg											
標準巻掛本数	2					1																					

注) カウンタウエイト12t、アウトリガ張出幅 7.0m

FL性能

30.0mブーム+1.85m+フルオートラフィングジブ

単位：t

ジブ長さ(m)	8.5					11.6					14.7					17.8					20.9				
	オフセット					オフセット					オフセット					オフセット					オフセット				
	5°	15°	30°	45°	60°	5°	15°	30°	45°	60°	5°	15°	30°	45°	60°	5°	15°	30°	45°	60°	5°	15°	30°	45°	60°
7.0	26.1	20.9				14.6					13.9														
8.0	24.4	19.9				14.6	14.6				13.9					13.5									
9.0	22.8	19.0	15.8			14.6	14.6				13.9					13.4					5.6				
10.0	21.5	18.2	15.3	13.6		14.6	14.5				13.9	12.4				13.0					5.6				
11.0	20.3	17.4	14.9	13.3	12.2	14.6	13.8	11.5			13.9	11.8				12.5	10.2				5.6				
12.0	19.2	16.7	14.5	13.1	12.1	14.6	13.2	11.2			13.4	11.3				11.7	9.8				5.6				
14.0	16.7	15.5	13.8	12.7	11.9	13.9	12.2	10.6	9.5	8.6	12.0	10.3	8.8			10.4	8.9				5.6	5.6			
16.0	12.4	13.3	13.2	12.4	11.8	12.6	11.3	10.0	9.2	8.5	10.8	9.5	8.3	7.4		9.3	8.2	7.0			5.6	5.6			
18.0	9.1	10.0	10.9	11.5	11.7	10.5	10.5	9.6	8.9	8.4	9.8	8.8	7.8	7.1	6.5	8.4	7.6	6.6	5.8		5.6	5.6	5.6		
20.0	6.4	7.1	8.0	8.6		7.8	8.9	9.1	8.7	8.3	8.9	8.2	7.5	6.9	6.4	7.7	7.0	6.3	5.6	5.0	5.6	5.6	5.6		
22.0	4.2	4.8	5.6	6.0		5.6	6.5	7.6	8.3	8.3	6.7	7.7	7.1	6.7	6.3	7.0	6.5	6.0	5.4	4.9	5.6	5.6	5.3	4.6	
24.0		3.0	3.6	3.9		3.8	4.6	5.5	6.1		4.9	5.8	6.8	6.5	6.3	5.7	6.1	5.7	5.3	4.8	5.6	5.5	5.0	4.5	4.0
26.0						2.3	3.0	3.7	4.2		3.4	4.2	5.3	6.0		4.2	5.2	5.4	5.1	4.8	5.3	5.2	4.8	4.3	3.9
28.0							1.6	2.2	2.6		2.1	2.8	3.7	4.3		2.9	3.8	5.0	5.0		4.0	4.8	4.6	4.2	3.9
30.0												1.6	2.4	2.8		1.8	2.6	3.6	4.3		2.8	3.8	4.4	4.1	3.8
32.0																	1.5	2.4	2.9		1.9	2.7	3.8	4.0	
34.0																			1.7			1.7	2.7	3.4	
36.0																							1.7	2.3	
(°)	54~84	52~84	54~84	55~84	65~84	51~84	49~84	52~84	50~84	65~84	51~84	50~84	54~84	51~84	66~84	51~84	51~84	55~84	51~84	67~84	52~84	52~84	53~84	52~84	68~84
標準フック	80t					25t										7.8t									
フック質量	1150kg					450kg										300kg									
標準巻掛本数	4					2										1									

注) カウンタウエイト35t、アウトリガ張出幅 5.6m

FL性能

34.1mブーム+1.85m+フルオートラフィングジブ

単位：t

ジブ長さ(m)	8.5					11.6					14.7					17.8					20.9				
	オフセット					オフセット					オフセット					オフセット					オフセット				
	5°	15°	30°	45°	60°	5°	15°	30°	45°	60°	5°	15°	30°	45°	60°	5°	15°	30°	45°	60°	5°	15°	30°	45°	60°
7.0	27.5	21.5				14.6																			
8.0	25.8	20.5				14.6					13.9					13.5									
9.0	24.2	19.7	16.0			14.6	14.6				13.9					13.2									
10.0	22.8	18.8	15.6			14.6	14.6				13.9	12.8				12.8									
11.0	21.6	18.1	15.2	13.4		14.6	14.6	11.9			13.9	12.2				12.4	10.5				5.6				
12.0	20.5	17.4	14.8	13.2	12.1	14.6	14.1	11.6			13.9	11.7				12.0	10.0				5.6				
14.0	16.6	16.2	14.1	12.8	11.9	14.6	13.0	11.0	9.7		12.8	10.7	8.9			11.0	9.2				5.6	5.6			
16.0	12.4	13.3	13.5	12.5	11.8	13.6	12.1	10.4	9.4	8.6	11.5	9.9	8.4	7.4		9.9	8.5	7.1			5.6	5.6			
18.0	9.1	10.0	10.9	11.6	11.7	10.4	11.3	10.0	9.1	8.4	10.4	9.2	8.0	7.2	6.5	9.0	7.8	6.7			5.6	5.6	5.6		
20.0	6.3	7.1	8.1	8.7	9.0	7.7	8.8	9.5	8.9	8.4	8.8	8.6	7.6	6.9	6.4	8.2	7.3	6.4	5.6		5.6	5.6	5.6		
22.0	4.2	4.8	5.7	6.2		5.5	6.4	7.6	8.4	8.3	6.5	7.7	7.3	6.7	6.3	7.3	6.8	6.1	5.5	4.9	5.6	5.6	5.4	4.6	
24.0			3.7	4.1		3.7	4.5	5.5	6.2		4.7	5.7	7.0	6.6	6.2	5.5	6.4	5.8	5.3	4.8	5.6	5.6	5.1	4.5	3.9
26.0							2.9	3.8	4.3		3.2	4.1	5.2	6.1	6.2	4.0	5.0	5.6	5.2	4.7	5.0	5.4	4.9	4.3	3.9
28.0								2.3	2.7			2.7	3.7	4.4		2.7	3.6	4.9	5.0	4.7	3.7	4.8	4.7	4.2	3.8
30.0													2.4	2.9			2.4	3.5	4.3		2.6	3.6	4.5	4.1	3.8
32.0																		2.3	3.0			2.5	3.7	4.0	
34.0																			1.8				2.6	3.4	
36.0																							1.7	2.3	
(°)	58~84	60~84	58~84	59~84	66~84	58~84	57~84	56~84	58~84	66~84	58~84	58~84	58~84	59~84	66~84	58~84	58~84	58~84	57~84	67~84	58~84	59~84	57~84	60~84	68~84
標準フック	80t					25t										7.8t									
フック質量	1150kg					450kg										300kg									
標準巻掛本数	4					2										1									

注) カウンタウエイト35t、アウトリガ張出幅 5.6m

FL性能

38.3mブーム+1.85m+フルオートラフィングジブ

単位：t

ジブ長さ(m)	8.5					11.6					14.7					17.8					20.9						
	オフセット					オフセット					オフセット					オフセット					オフセット						
	5°	15°	30°	45°	60°	5°	15°	30°	45°	60°	5°	15°	30°	45°	60°	5°	15°	30°	45°	60°	5°	15°	30°	45°	60°		
7.0	25.0																										
8.0	25.0	21.6				14.6																					
9.0	25.0	20.7				14.6					13.9					12.9											
10.0	24.7	19.9	16.1			14.6	14.6				13.9					12.6											
11.0	23.4	19.1	15.7			14.6	14.6				13.9	12.6				12.2							5.6				
12.0	22.2	18.4	15.3	13.5	12.2	14.6	14.6	11.8			13.9	12.1				11.8	10.1						5.6				
14.0	16.7	17.2	14.6	13.1	12.1	14.6	13.6	11.2	9.8		13.6	11.1	9.1			11.1	9.5						5.6				
16.0	12.5	13.3	14.0	12.8	11.9	13.5	12.6	10.7	9.5	8.6	12.3	10.3	8.6			10.6	8.8	7.2					5.6	5.6			
18.0	9.1	10.1	11.0	11.7	11.8	10.3	11.4	10.2	9.2	8.5	11.1	9.6	8.2	7.3		9.6	8.2	6.9					5.6	5.6			
20.0	6.4	7.2	8.2	8.9	9.2	7.6	8.7	9.8	9.0	8.4	8.6	9.0	7.8	7.0	6.4	8.8	7.6	6.5	5.7				5.6	5.6	5.6		
22.0	4.2	4.9	5.8	6.4		5.4	6.4	7.6	8.4	8.3	6.4	7.6	7.5	6.8	6.3	7.1	7.1	6.2	5.5	4.9			5.6	5.6	5.5		
24.0			3.8	4.3		3.6	4.5	5.5	6.3	6.7	4.5	5.6	7.0	6.7	6.2	5.3	6.5	6.0	5.4	4.8			5.6	5.6	5.3	4.5	
26.0								3.8	4.4		3.0	4.0	5.2	6.1	6.2	3.8	4.9	5.7	5.2	4.8			4.8	5.6	5.0	4.4	3.9
28.0														3.7	4.4		3.5	4.8	5.1	4.7			3.5	4.6	4.8	4.3	3.8
30.0														3.0				3.4	4.3				3.4	4.6	4.2	3.8	
32.0																			3.0					2.3	3.6	4.1	3.8
34.0																									2.5	3.4	
36.0																										2.3	
(°)	61-84	63-84	62-84	63-84	67-84	61-84	63-84	63-84	63-84	61-84	67-84	61-84	63-84	63-84	63-84	63-84	67-84	62-84	63-84	64-84	64-84	68-84	63-84	61-84	63-84	63-84	68-84
標準フック	80t					25t										7.8t											
フック質量	1150kg					450kg										300kg											
標準巻掛本数	4					2										1											

注) カウンタウエイト35t、アウトリガ張出幅 5.6m

FL性能

42.5mブーム+1.85m+フルオートラフィングジブ

単位：t

ジブ長さ(m)	8.5					11.6					14.7					17.8					20.9								
	オフセット					オフセット					オフセット					オフセット					オフセット								
	5°	15°	30°	45°	60°	5°	15°	30°	45°	60°	5°	15°	30°	45°	60°	5°	15°	30°	45°	60°	5°	15°	30°	45°	60°				
8.0	21.3																												
9.0	21.3	21.3				14.6																							
10.0	21.3	20.5				14.6					13.9					11.5													
11.0	21.3	19.7	15.9			14.6	14.6				13.9					11.5													
12.0	21.0	19.0	15.6	13.6		14.6	14.6				13.8	12.0				11.5								5.6					
14.0	16.9	17.8	14.9	13.3	12.1	14.6	14.1	11.4			13.1	11.4				10.8	9.4							5.6					
16.0	12.6	13.5	14.3	12.9	12.0	13.6	13.1	10.9	9.6	8.6	12.4	10.7	8.8			10.2	8.9						5.6	5.6					
18.0	9.3	10.3	11.2	11.9	11.8	10.4	11.5	10.5	9.4	8.5	11.2	10.0	8.4	7.3		9.8	8.5	7.0					5.6	5.6					
20.0	6.6	7.4	8.5	9.2	9.5	7.7	8.9	10.0	9.1	8.4	8.6	9.4	8.0	7.1	6.4	9.3	7.9	6.7	5.8				5.6	5.6	5.6				
22.0	4.4	5.2	6.0	6.7	6.9	5.5	6.5	7.8	8.6	8.3	6.4	7.6	7.7	6.9	6.3	7.1	7.4	6.4	5.6	4.9			5.6	5.6	5.5				
24.0			4.1	4.6		3.8	4.6	5.7	6.5	6.9	4.6	5.7	7.1	6.8	6.3	5.3	6.6	6.1	5.4	4.8			5.6	5.6	5.3	4.6			
26.0								4.0	4.7	5.0		4.1	5.3	6.3	6.2	3.8	4.9	5.9	5.3	4.8			4.8	5.6	5.1	4.4	3.9		
28.0														3.8	4.6	5.0		3.5	4.9	5.2	4.7			3.5	4.7	4.9	4.3	3.9	
30.0														3.2				3.5	4.5	4.7				3.4	4.8	4.2	3.8		
32.0																			3.2						3.7	4.1	3.8		
34.0																									2.6	3.5	3.7		
36.0																										2.5			
(°)	64-84	65-84	64-84	65-84	67-84	63-84	65-84	65-84	67-84	67-84	65-84	65-84	66-84	65-84	67-84	65-84	65-84	66-84	66-84	68-84	64-84	65-84	65-84	65-84	68-84	64-84	65-84	65-84	68-84
標準フック	25t					25t										7.8t													
フック質量	450kg					450kg										300kg													
標準巻掛本数	3					2										1													

注) カウンタウエイト35t、アウトリガ張出幅 5.6m

FL性能

4.6.7mブーム+1.85m+フルオートラフィングジブ

単位：t

ジブ長さ(m) 作業半径(m)	8.5					11.6					14.7					17.8					20.9						
	オフセット					オフセット					オフセット					オフセット					オフセット						
	5°	15°	30°	45°	60°	5°	15°	30°	45°	60°	5°	15°	30°	45°	60°	5°	15°	30°	45°	60°	5°	15°	30°	45°	60°		
9.0	17.5																										
10.0	17.5	17.5				14.2																					
11.0	17.5	17.5				14.2					12.0					10.1											
12.0	17.5	17.5	15.8			14.2	14.2				12.0					10.1											
14.0	16.9	16.4	15.2	13.4		14.2	14.0	11.6			12.0	11.1				10.1	9.1						5.6				
16.0	12.8	13.7	14.6	13.1	12.0	13.7	13.6	11.1	9.7		12.0	10.6	8.9			9.9	8.7						5.6				
18.0	9.5	10.4	11.4	12.1	11.9	10.5	11.6	10.7	9.5	8.5	11.2	10.2	8.5			9.4	8.3	7.0					5.6	5.6			
20.0	6.8	7.6	8.7	9.3	9.7	7.9	9.0	10.1	9.2	8.4	8.7	9.7	8.2	7.2	6.4	9.0	8.0	6.8					5.6	5.6			
22.0		5.3	6.2	6.9	7.2	5.6	6.6	7.9	8.7	8.4	6.5	7.7	7.9	7.0	6.4	7.2	7.6	6.5	5.6				5.6	5.6	5.4		
24.0			4.3	4.8			4.7	5.8	6.7	7.1	4.7	5.7	7.2	6.8	6.3	5.3	6.6	6.2	5.5	4.8			5.6	5.6	5.2		
26.0								4.1	4.8	5.2		4.1	5.4	6.4	6.2		4.9	6.0	5.4	4.8			4.8	5.6	5.1	4.5	
28.0													3.9	4.8	5.2			4.9	5.2	4.7			4.7	4.9	4.4	3.9	
30.0															3.7			3.6	4.6	4.7			3.4	4.7	4.3	3.8	
32.0																			3.3	3.8				3.7	4.2	3.8	
34.0																									3.6	3.7	
(°)	68-84	67-84	66-84	68-84	68-84	67-84	67-84	67-84	69-84	68-84	67-84	67-84	68-84	69-84	68-84	68-84	69-84	68-84	68-84	69-84	68-84	69-84	68-84	67-84	69-84	69-84	69-84
標準フック	25t					25t					25t					7.8t											
フック質量	450kg					450kg					450kg					300kg											
標準巻掛本数	3					2					1																

注) カウンタウエイト35t、アウトリガ張出幅 5.6m

FL性能

5.0.9mブーム+1.85m+フルオートラフィングジブ

単位：t

ジブ長さ(m) 作業半径(m)	8.5					11.6					14.7					17.8					20.9					
	オフセット					オフセット					オフセット					オフセット					オフセット					
	5°	15°	30°	45°	60°	5°	15°	30°	45°	60°	5°	15°	30°	45°	60°	5°	15°	30°	45°	60°	5°	15°	30°	45°	60°	
10.0	13.8																									
11.0	13.8	13.8				11.8																				
12.0	13.8	13.8				11.8					10.1															
14.0	13.8	13.8	13.3	13.0		11.8	11.8				10.1	10.1				6.7										
16.0	13.2	13.0	12.5	12.2	12.1	11.8	11.8	11.3			10.1	10.0				6.7								5.6		
18.0	10.0	10.8	11.7	11.5	11.4	10.7	11.2	10.7	9.5		10.1	9.6	8.4			6.7	6.7						5.6	5.6		
20.0	7.2	8.0	9.1	9.7	10.0	8.1	9.2	10.1	9.3	8.5	8.9	9.5	8.2	7.3		6.7	6.7	6.7					5.6	5.6		
22.0	5.1	5.8	6.7	7.3	7.7	5.9	6.9	8.1	8.9	8.4	6.7	7.9	7.9	7.1	6.4	6.7	6.7	6.5					5.6	5.6	5.3	
24.0			4.7	5.3	5.5		5.0	6.1	6.9	7.4	4.8	5.9	7.4	6.9	6.3	5.8	6.7	6.3	5.7				5.6	5.6	5.1	
26.0								4.4	5.1	5.5			5.6	6.6	6.2		5.4	6.1	5.6	5.0			4.9	5.6	5.0	4.5
28.0													4.1	5.0	5.5			5.4	5.5	5.0			4.8	4.8	4.4	3.9
30.0															4.0			4.0	5.0	4.9				4.7	4.3	3.8
32.0																			3.7	4.2				3.8	4.2	3.8
34.0																									3.8	3.8
36.0																										3.2
(°)	68-84	69-84	68-84	69-84	69-84	69-84	69-84	69-84	70-84	69-84	68-84	70-84	69-84	71-84	70-84	70-84	70-84	70-84	71-84	69-84	70-84	70-84	71-84	70-84	71-84	70-84
標準フック	25t					25t					7.8t															
フック質量	450kg					450kg					300kg															
標準巻掛本数	2					1																				

注) カウンタウエイト35t、アウトリガ張出幅 5.6m

FL性能

5.5.0mブーム+1.85m+フルオートラフィングジブ

単位：t

ジブ長さ(m) 作業半径(m)	8.5					11.6					14.7					17.8					20.9					
	オフセット					オフセット					オフセット					オフセット					オフセット					
	5°	15°	30°	45°	60°	5°	15°	30°	45°	60°	5°	15°	30°	45°	60°	5°	15°	30°	45°	60°	5°	15°	30°	45°	60°	
11.0	11.5																									
12.0	11.5	11.5				10.0																				
14.0	11.5	11.5	11.4			10.0	10.0				6.9					6.7										
16.0	11.2	11.0	10.6	10.4	10.4	10.0	9.9	9.7			6.9					6.7								5.6		
18.0	10.3	10.2	9.9	9.7	9.7	9.6	9.5	9.1	8.9		6.9	6.9				6.7	6.7						5.6	5.6		
20.0	7.5	8.3	9.3	9.1	9.1	8.3	8.9	8.6	8.4	8.4	6.9	6.9	6.9			6.7	6.7						5.6	5.6		
22.0		6.0	7.0	7.6	8.0	6.1	7.1	8.1	8.0	8.0	6.9	6.9	6.9	6.9		6.7	6.7	6.3					5.6	5.6		
24.0				5.6	5.8		5.2	6.3	7.2	7.5	5.3	6.4	6.9	6.9	6.4	5.9	6.7	6.1	5.6				5.6	5.6	5.0	
26.0								5.3	5.8			4.8	6.0	6.6	6.3		5.5	5.9	5.5	5.1			5.0	5.6	4.8	
28.0													4.5	5.4	6.0			5.5	5.4	5.0			4.9	4.7	4.3	
30.0														4.0	4.5			4.2	5.1	4.9				4.6	4.2	3.9
32.0																			3.9	4.4				4.0	4.1	3.8
34.0																									3.9	3.8
36.0																										3.4
(°)	71-84	70-84	72-84	71-84	71-84	70-84	70-84	72-84	72-84	72-84	70-84	70-84	71-84	71-84	72-84	71-84	71-84	71-84	72-84	70-84	71-84	71-84	71-84	72-84	72-84	72-84
標準フック	25t					25t					7.8t															
フック質量	450kg					450kg					300kg															
標準巻掛本数	2					1																				

注) カウンタウエイト35t、アウトリガ張出幅 5.6m

FL性能

59.2mブーム+1.85m+フルオートラフィングジブ

単位：t

ジブ長さ(m)	8.5					11.6					14.7					17.8					20.9				
	オフセット					オフセット					オフセット					オフセット					オフセット				
	5°	15°	30°	45°	60°	5°	15°	30°	45°	60°	5°	15°	30°	45°	60°	5°	15°	30°	45°	60°	5°	15°	30°	45°	60°
11.0	9.6																								
12.0	9.6	9.4				7.5																			
14.0	9.0	8.7	8.3			7.5	7.5				6.5					5.7									
16.0	8.4	8.3	7.7	7.5		7.5	7.4				6.5	6.5				5.7					5.0				
18.0	8.1	7.8	7.3	7.1	7.0	7.2	6.9	6.5			6.5	6.3				5.7	5.7				5.0				
20.0	7.5	7.3	6.9	6.7	6.6	7.0	6.5	6.1	5.9		6.3	6.0	5.5			5.7	5.5				5.0	5.0			
22.0		6.4	6.6	6.3	6.3	6.5	6.2	5.8	5.6	5.5	5.9	5.6	5.2	5.0		5.5	5.2	4.8			5.0	4.8			
24.0				5.9	6.0		5.8	5.5	5.3	5.3	5.6	5.3	5.0	4.8	4.7	5.2	4.9	4.6			4.8	4.5	4.2		
26.0								5.2	5.0	5.0		5.0	4.8	4.6	4.5		4.7	4.4	4.2		4.6	4.3	4.0		
28.0													4.4	4.7				4.2	4.0	3.9		4.1	3.8	3.6	
30.0																		4.0	3.8	3.8			3.6	3.5	
32.0																			3.7	3.6			3.5	3.3	3.3
34.0																							3.2	3.2	
36.0																								3.1	
(°)	72-84	72-84	73-84	72-84	73-84	72-84	72-84	72-84	71-84	72-84	71-84	71-84	72-84	72-84	73-84	72-84	73-84	72-84	74-84	72-84	72-84	72-84	73-84	73-84	
標準フック	25t										7.8t														
フック質量	450kg										300kg														
標準巻掛本数	2										1														

注) カウンタウエイト35t、アウトリガ張出幅 5.6m

FL性能

63.4mブーム+1.85m+フルオートラフィングジブ

単位：t

ジブ長さ(m)	8.5					11.6					14.7					17.8					20.9					
	オフセット					オフセット					オフセット					オフセット					オフセット					
	5°	15°	30°	45°	60°	5°	15°	30°	45°	60°	5°	15°	30°	45°	60°	5°	15°	30°	45°	60°	5°	15°	30°	45°	60°	
14.0	7.0	7.0				6.1					5.4															
16.0	6.8	6.6	6.3			6.1	6.0				5.4					4.7										
18.0	6.3	6.1	5.9	5.7		5.9	5.7	5.3			5.4	5.2				4.7					4.2					
20.0	6.0	5.8	5.5	5.3	5.3	5.5	5.3	5.0	4.8		5.2	4.9				4.7	4.5				4.2					
22.0	5.6	5.4	5.1	5.0	5.0	5.2	5.0	4.7	4.5	4.5	4.8	4.6	4.3			4.6	4.3				4.2	4.0				
24.0			4.8	4.7	4.7		4.7	4.4	4.3	4.2	4.5	4.3	4.1	3.9		4.3	4.0	3.8			4.0	3.7				
26.0					4.4			4.2	4.1	4.0		4.1	3.9	3.7	3.7		3.8	3.6			3.8	3.5	3.3			
28.0										3.9	3.8			3.6	3.5	3.5			3.4	3.3	3.2		3.4	3.1		
30.0														3.3	3.3				3.2	3.1	3.1			3.0	2.9	
32.0																			2.9	2.9				2.8	2.7	2.7
34.0																								2.6	2.6	
36.0																									2.4	
(°)	72-84	73-84	72-84	73-84	72-84	73-84	73-84	73-84	72-84	73-84	72-84	72-84	73-84	73-84	74-84	73-84	73-84	73-84	73-84	75-84	72-84	73-84	73-84	74-84	74-84	
標準フック											7.8t															
フック質量											300kg															
標準巻掛本数											1															

注) カウンタウエイト35t、アウトリガ張出幅 5.6m

F M性能

30.0mブーム+1.85m+フルオートラフィングジブ

単位：t

ジブ長さ(m)	8.5					11.6					14.7					17.8					20.9				
	オフセット					オフセット					オフセット					オフセット					オフセット				
	5°	15°	30°	45°	60°	5°	15°	30°	45°	60°	5°	15°	30°	45°	60°	5°	15°	30°	45°	60°	5°	15°	30°	45°	60°
7.0	26.1	20.9				14.6					13.9														
8.0	24.4	19.9				14.6	14.6				13.9					13.5									
9.0	22.8	19.0	15.8			14.6	14.6				13.9					13.4					5.6				
10.0	21.5	18.2	15.3	13.6		14.6	14.5				13.9	12.4				13.0					5.6				
11.0	19.9	17.4	14.9	13.3	12.2	14.6	13.8	11.5			13.9	11.8				12.5	10.2				5.6				
12.0	16.5	16.7	14.5	13.1	12.1	14.6	13.2	11.2			13.4	11.3				11.7	9.8				5.6				
14.0	11.5	12.5	13.8	12.7	11.9	12.9	12.2	10.6	9.5	8.6	12.0	10.3	8.8			10.4	8.9				5.6	5.6			
16.0	7.8	8.9	10.0	10.8	11.2	9.3	10.4	10.0	9.2	8.5	10.3	9.5	8.3	7.4		9.3	8.2	7.0			5.6	5.6			
18.0	4.9	5.8	6.9	7.6	7.9	6.4	7.6	8.9	8.9	8.4	7.5	8.8	7.8	7.1	6.5	8.3	7.6	6.6	5.8		5.6	5.6	5.6		
20.0			4.3	4.9		4.1	5.1	6.4	7.3	7.7	5.2	6.5	7.5	6.9	6.4	6.1	7.0	6.3	5.6	5.0	5.6	5.6	5.6		
22.0							3.1	4.2	5.0	5.4	3.3	4.4	5.9	6.7	6.3	4.2	5.5	6.0	5.4	4.9	5.4	5.6	5.3	4.6	
24.0									3.1				4.0	5.0	5.5		3.8	5.4	5.3	4.8	3.8	5.1	5.0	4.5	4.0
26.0													3.3				3.8	4.8	4.8	2.5	3.7	4.8	4.3	3.9	
28.0																		3.3			2.4	3.9	4.2	3.9	
30.0																						2.7	3.6	3.8	
32.0																							2.4		
(°)	61-84	63-84	62-84	63-84	65-84	61-84	60-84	63-84	61-84	65-84	60-84	63-84	64-84	63-84	66-84	63-84	63-84	64-84	64-84	67-84	60-84	61-84	63-84	63-84	68-84
標準フック	80 t					25t										7.8t									
フック質量	1150kg					450kg										300kg									
標準巻掛本数	4					2										1									

注) カウンタウエイト23.5t、アウトリガ張出幅 5.6m

F M性能

34.1mブーム+1.85m+フルオートラフィングジブ

単位：t

ジブ長さ(m)	8.5					11.6					14.7					17.8					20.9				
	オフセット					オフセット					オフセット					オフセット					オフセット				
	5°	15°	30°	45°	60°	5°	15°	30°	45°	60°	5°	15°	30°	45°	60°	5°	15°	30°	45°	60°	5°	15°	30°	45°	60°
7.0	27.5	21.5				14.6																			
8.0	25.8	20.5				14.6					13.9					13.5									
9.0	24.2	19.7	16.0			14.6	14.6				13.9					13.2									
10.0	22.8	18.8	15.6			14.6	14.6				13.9	12.8				12.8									
11.0	19.8	18.1	15.2	13.4		14.6	14.6	11.9			13.9	12.2				12.4	10.5				5.6				
12.0	16.4	17.4	14.8	13.2	12.1	14.6	14.1	11.6			13.9	11.7				12.0	10.0				5.6				
14.0	11.5	12.5	13.9	12.8	11.9	12.8	13.0	11.0	9.7		12.8	10.7	8.9			11.0	9.2				5.6	5.6			
16.0	7.7	8.8	10.0	10.8	11.3	9.2	10.4	10.4	9.4	8.6	10.1	9.9	8.4	7.4		9.9	8.5	7.1			5.6	5.6			
18.0		5.7	6.9	7.7	8.1	6.3	7.5	8.9	9.1	8.4	7.3	8.7	8.0	7.2	6.5	8.2	7.8	6.7			5.6	5.6	5.6		
20.0					5.3		5.0	6.4	7.4	7.9	5.0	6.3	7.6	6.9	6.4	5.9	7.3	6.4	5.6		5.6	5.6	5.6		
22.0								4.3	5.1	5.5		4.3	5.9	6.7	6.3	4.0	5.3	6.1	5.5	4.9	5.1	5.6	5.4	4.6	
24.0													4.0	5.0	5.6		3.7	5.3	5.3	4.8	3.5	4.9	5.1	4.5	3.9
26.0													3.3	3.7			3.7	4.8	4.7		3.5	4.9	4.3	3.9	
28.0																		3.3	3.8			3.8	4.2	3.8	
30.0																							3.6	3.8	
32.0																							2.4		
(°)	67-84	66-84	68-84	69-84	67-84	66-84	66-84	66-84	68-84	66-84	66-84	66-84	66-84	66-84	66-84	65-84	66-84	67-84	67-84	67-84	65-84	66-84	68-84	66-84	68-84
標準フック	80 t					25t										7.8t									
フック質量	1150kg					450kg										300kg									
標準巻掛本数	4					2										1									

注) カウンタウエイト23.5t、アウトリガ張出幅 5.6m

F M性能

3.8.3mブーム+1.85m+フルオートラフィングジブ

単位：t

ジブ長さ(m)	8.5					11.6					14.7					17.8					20.9				
	オフセット					オフセット					オフセット					オフセット					オフセット				
	5°	15°	30°	45°	60°	5°	15°	30°	45°	60°	5°	15°	30°	45°	60°	5°	15°	30°	45°	60°	5°	15°	30°	45°	60°
7.0	25.0																								
8.0	25.0	21.6				14.6																			
9.0	25.0	20.7				14.6					13.9					12.9									
10.0	24.2	19.9	16.1			14.6	14.6				13.9					12.6									
11.0	19.9	19.1	15.7			14.6	14.6				13.9	12.6				12.2							5.6		
12.0	16.5	17.9	15.3	13.5	12.2	14.6	14.6	11.8			13.9	12.1				11.8	10.1						5.6		
14.0	11.5	12.6	14.0	13.1	12.1	12.7	13.6	11.2	9.8		13.6	11.1	9.1			11.1	9.5						5.6		
16.0	7.8	8.9	10.1	11.0	11.5	9.1	10.3	10.7	9.5	8.6	10.0	10.3	8.6			10.6	8.8	7.2					5.6	5.6	
18.0		5.8	7.0	7.9	8.3	6.1	7.4	8.9	9.2	8.5	7.2	8.6	8.2	7.3		8.0	8.2	6.9					5.6	5.6	
20.0				5.2	5.5		5.0	6.4	7.4	8.0		6.2	7.8	7.0	6.4	5.6	7.2	6.5	5.7				5.6	5.6	5.6
22.0									5.2	5.7			5.8	6.8	6.3		5.2	6.2	5.5	4.9	4.9	5.6	5.5		
24.0														5.0	5.7			5.2	5.4	4.8			4.8	5.3	4.5
26.0																		4.8	4.8				5.0	4.4	3.9
28.0																			3.9				3.7	4.3	3.8
30.0																								3.6	3.8
32.0																									3.0
(°)	69-84	68-84	70-84	69-84	69-84	68-84	68-84	71-84	70-84	71-84	70-84	70-84	71-84	71-84	69-84	69-84	70-84	71-84	72-84	71-84	69-84	70-84	70-84	71-84	70-84
標準フック	80 t					25t					7.8t														
フック質量	1150kg					450kg					300kg														
標準巻掛本数	4					2					1														

注) カウンタウエイト23.5t、アウトリガ張出幅 5.6m

F M性能

4.2.5mブーム+1.85m+フルオートラフィングジブ

単位：t

ジブ長さ(m)	8.5					11.6					14.7					17.8					20.9				
	オフセット					オフセット					オフセット					オフセット					オフセット				
	5°	15°	30°	45°	60°	5°	15°	30°	45°	60°	5°	15°	30°	45°	60°	5°	15°	30°	45°	60°	5°	15°	30°	45°	60°
8.0	21.3																								
9.0	21.3	21.3				14.6																			
10.0	21.3	20.5				14.6					13.9					11.5									
11.0	20.1	19.7	15.9			14.6	14.6				13.9					11.5									
12.0	16.7	18.0	15.6	13.6		14.6	14.6				13.8	12.0				11.5							5.6		
14.0	11.7	12.8	14.2	13.3	12.1	12.8	14.1	11.4			13.1	11.4				10.8	9.4						5.6		
16.0	8.0	9.1	10.3	11.2	11.7	9.2	10.4	10.9	9.6	8.6	10.0	10.7	8.8			10.2	8.9						5.6	5.6	
18.0			7.3	8.1	8.5	6.3	7.6	9.0	9.4	8.5	7.2	8.6	8.4	7.3		8.0	8.5	7.0					5.6	5.6	
20.0				5.5	5.8			6.6	7.6	8.1		6.3	7.9	7.1	6.4	5.7	7.2	6.7	5.8				5.6	5.6	5.6
22.0									5.4	5.9			5.9	6.9	6.3		5.2	6.4	5.6	4.9	4.8	5.6	5.5		
24.0														5.2	5.8			5.2	5.4	4.8			4.8	5.3	4.6
26.0																		4.9	4.8				5.1	4.4	3.9
28.0																				4.0			3.7	4.3	3.9
30.0																								3.7	3.8
32.0																									3.1
(°)	71-84	72-84	72-84	71-84	71-84	70-84	72-84	72-84	72-84	73-84	71-84	72-84	73-84	73-84	71-84	71-84	71-84	73-84	73-84	72-84	70-84	71-84	71-84	72-84	72-84
標準フック	25 t					25t					7.8t														
フック質量	450kg					450kg					300kg														
標準巻掛本数	3					2					1														

注) カウンタウエイト23.5t、アウトリガ張出幅 5.6m

F M性能

46.7mブーム+1.85m+フルオートラフィングジブ

単位：t

ジブ長さ(m) 作業半径(m)	8.5					11.6					14.7					17.8					20.9				
	オフセット					オフセット					オフセット					オフセット					オフセット				
	5°	15°	30°	45°	60°	5°	15°	30°	45°	60°	5°	15°	30°	45°	60°	5°	15°	30°	45°	60°	5°	15°	30°	45°	60°
9.0	17.5																								
10.0	17.5	17.5				14.2																			
11.0	17.5	17.5				14.2					12.0				10.1										
12.0	16.9	17.5	15.8			14.2	14.2				12.0				10.1										
14.0	11.9	12.9	14.4	13.4		12.9	14.0	11.6			12.0	11.1			10.1	9.1					5.6				
16.0	8.2	9.3	10.5	11.4	11.9	9.3	10.5	11.1	9.7		10.1	10.6	8.9		9.9	8.7					5.6				
18.0			7.5	8.3	8.7		7.7	9.1	9.5	8.5	7.3	8.7	8.5		8.0	8.3	7.0				5.6	5.6			
20.0					6.1			6.7	7.7	8.3		6.3	8.0	7.2	6.4		7.2	6.8			5.6	5.6			
22.0									5.5	6.1			6.0	7.0	6.4			6.5	5.6			5.6	5.4		
24.0													5.3	6.0				5.3	5.5	4.8			5.2		
26.0																			5.0	4.8			5.1	4.5	
28.0																							4.4	3.9	
30.0																							3.7	3.8	
(°)	72-84	74-84	73-84	75-84	73-84	74-84	73-84	74-84	73-84	74-84	73-84	73-84	74-84	74-84	75-84	74-84	74-84	74-84	74-84	76-84	73-84	74-84	74-84	76-84	
標準フック	25t					25t					25t					7.8t									
フック質量	450kg					450kg					450kg					300kg									
標準巻掛本数	3					2					2					1									

注)カウンタウエイト23.5t、アウトリガ張出幅 5.6m

F M性能

50.9mブーム+1.85m+フルオートラフィングジブ

単位：t

ジブ長さ(m) 作業半径(m)	8.5					11.6					14.7					17.8					20.9				
	オフセット					オフセット					オフセット					オフセット					オフセット				
	5°	15°	30°	45°	60°	5°	15°	30°	45°	60°	5°	15°	30°	45°	60°	5°	15°	30°	45°	60°	5°	15°	30°	45°	60°
10.0	13.8																								
11.0	13.8	13.8				11.8																			
12.0	13.8	13.8				11.8					10.1														
14.0	12.3	13.4	13.3	13.0		11.8	11.8				10.1	10.1			6.7										
16.0	8.7	9.7	10.8	11.7	12.1	9.6	10.7	11.3			10.1	10.0			6.7						5.6				
18.0			7.9	8.7	9.1		7.9	9.3	9.5			8.8	8.4		6.7	6.7					5.6	5.6			
20.0					6.6			6.9	7.9	8.5			8.1	7.3		6.7	6.7				5.6	5.6			
22.0										6.4			6.1	7.1	6.4			6.5				5.6	5.3		
24.0													5.5	6.1				5.7	5.7				5.1		
26.0																			5.4	5.0			5.0	4.5	
28.0																				4.6			4.4	3.9	
30.0																								3.8	
(°)	74-84	75-84	75-84	76-84	74-84	75-84	74-84	75-84	76-84	75-84	76-84	76-84	75-84	75-84	76-84	75-84	76-84	75-84	76-84	75-84	74-84	75-84	75-84	77-84	77-84
標準フック	25t					25t					25t					7.8t									
フック質量	450kg					450kg					450kg					300kg									
標準巻掛本数	2					2					2					1									

注)カウンタウエイト23.5t、アウトリガ張出幅 5.6m

F M性能

55.0mブーム+1.85m+フルオートラフィングジブ

単位：t

ジブ長さ(m) 作業半径(m)	8.5					11.6					14.7					17.8					20.9				
	オフセット					オフセット					オフセット					オフセット					オフセット				
	5°	15°	30°	45°	60°	5°	15°	30°	45°	60°	5°	15°	30°	45°	60°	5°	15°	30°	45°	60°	5°	15°	30°	45°	60°
11.0	11.5																								
12.0	11.5	11.5				10.0																			
14.0	11.5	11.5	11.4			10.0	10.0				6.9				6.7										
16.0		9.9	10.6	10.4	10.4	9.7	9.9	9.7			6.9				6.7						5.6				
18.0			8.2	8.9	9.3		8.1	9.1	8.9		6.9	6.9			6.7	6.7					5.6				
20.0					6.8			7.1	8.1	8.4		6.9	6.9			6.7					5.6	5.6			
22.0										6.6			6.6	6.9				6.3				5.6			
24.0													5.9	6.4				5.8	5.6				5.0		
26.0																		5.5	5.1				4.8		
28.0																				4.8				4.3	
30.0																								3.9	
(°)	77-84	76-84	76-84	77-84	75-84	76-84	75-84	76-84	77-84	76-84	75-84	75-84	76-84	76-84	78-84	76-84	76-84	76-84	77-84	76-84	75-84	76-84	76-84	77-84	78-84
標準フック	25t					25t					25t					7.8t									
フック質量	450kg					450kg					450kg					300kg									
標準巻掛本数	2					2					2					1									

注)カウンタウエイト23.5t、アウトリガ張出幅 5.6m

フルオートラフィングジブ 作業半径 - 揚程図

30.0mブーム + 1.85m + フルオートラフィングジブ

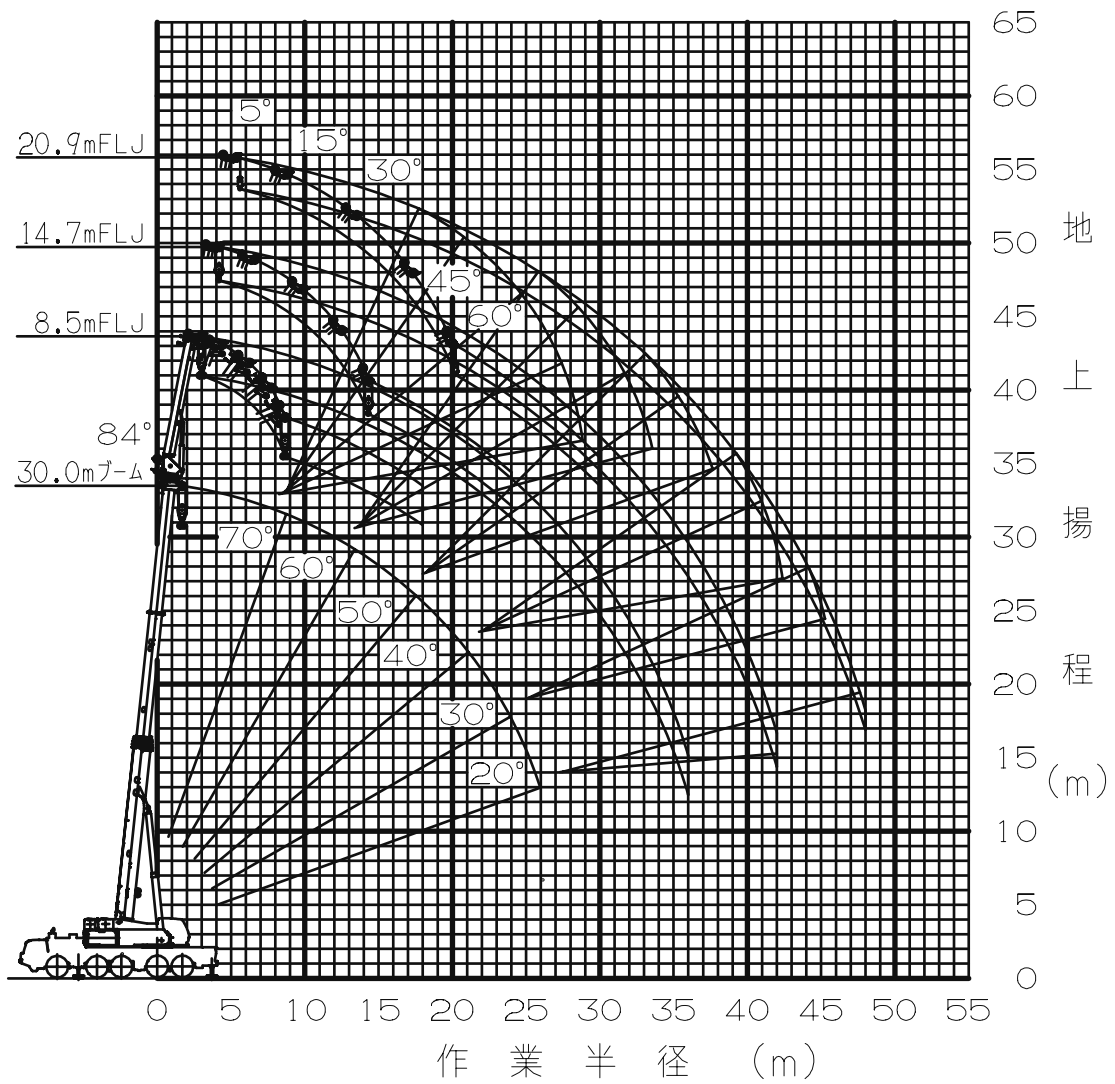

- (注) 1. 上図はブームおよびジブのたわみを含んでいません。
 2. F A性能の最大作業半径を図示しています。

34.1mブーム + 1.85m + フルオートラフィングジブ

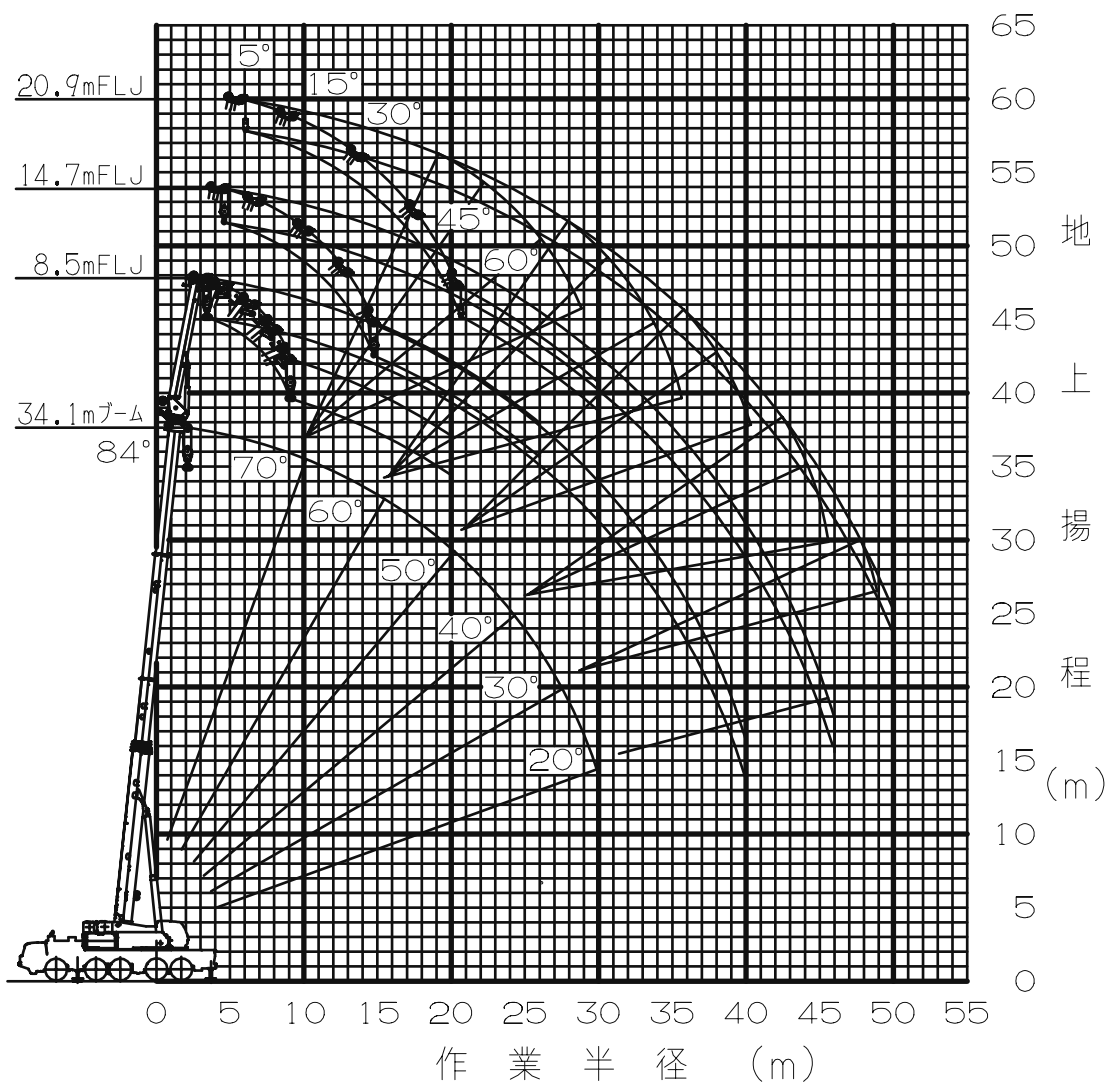

- (注) 1 . 上図はブームおよびジブのたわみを含んでいません。
2 . F A 性能の最大作業半径を図示しています。

38.3mブーム + 1.85m + フルオートラフィングジブ

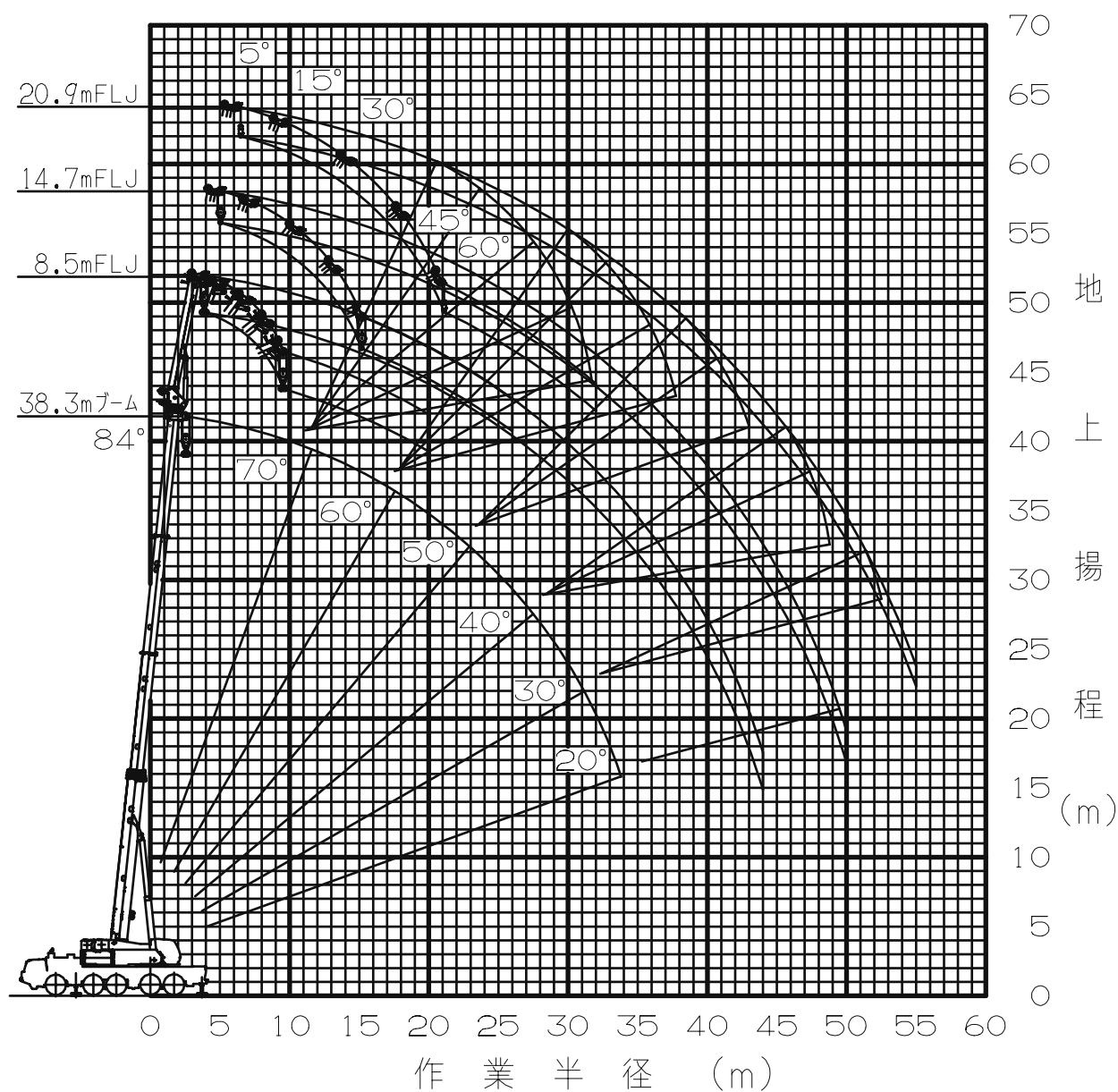

- (注) 1. 上図はブームおよびジブのたわみを含んでいません。
 2. FA性能の最大作業半径を図示しています。

42.5mブーム + 1.85m + フルオートラフィングジブ

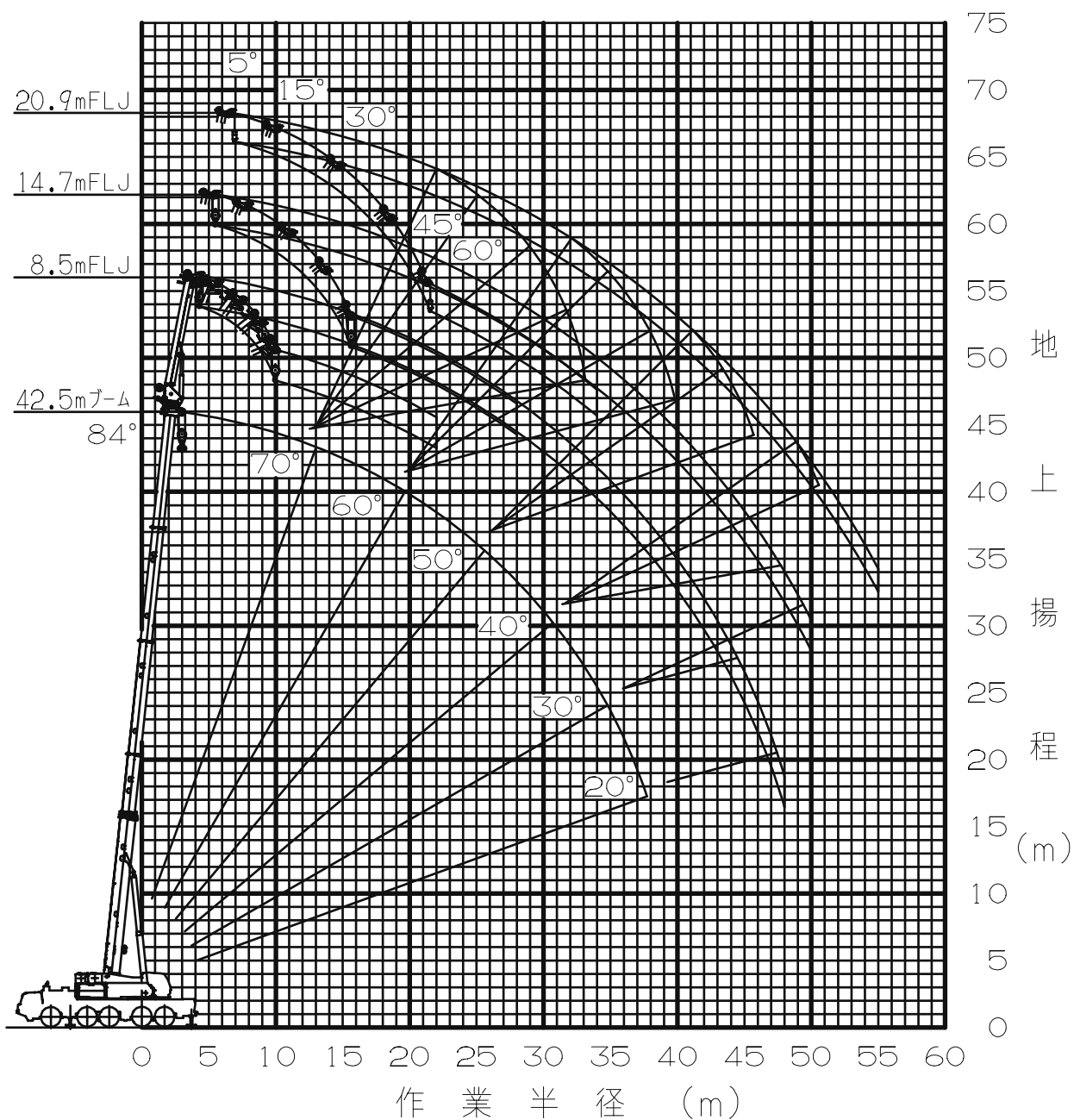

(注) 1. 上図はブームおよびジブのたわみを含んでいません。

2. F A 性能の最大作業半径を図示しています。

46.7mブーム + 1.85m + フルオートラフィングジブ

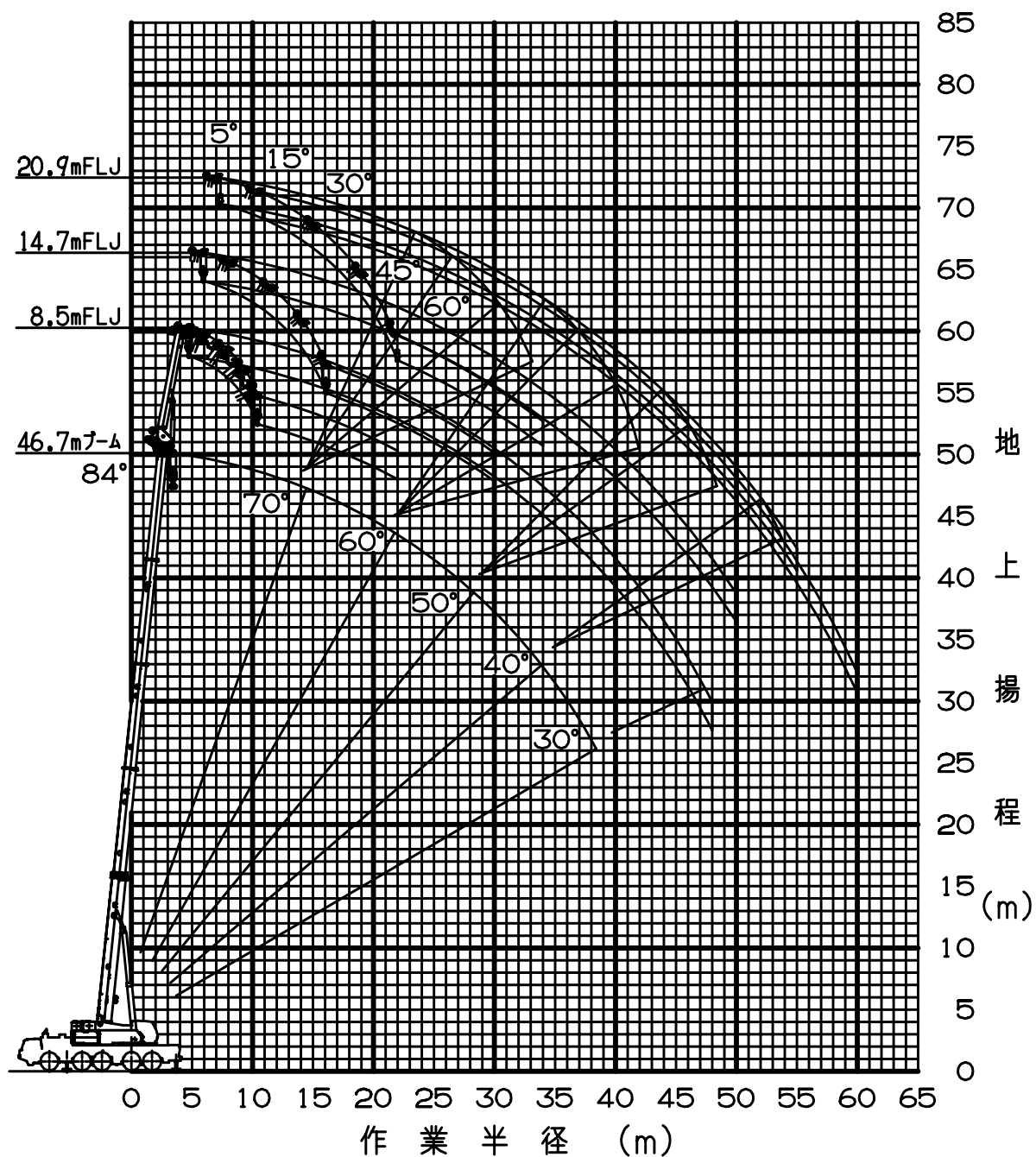

- (注) 1. 上図はブームおよびジブのたわみを含んでいません。
 2. F A性能の最大作業半径を図示しています。

50.9mブーム + 1.85m + フルオートラフィングジブ

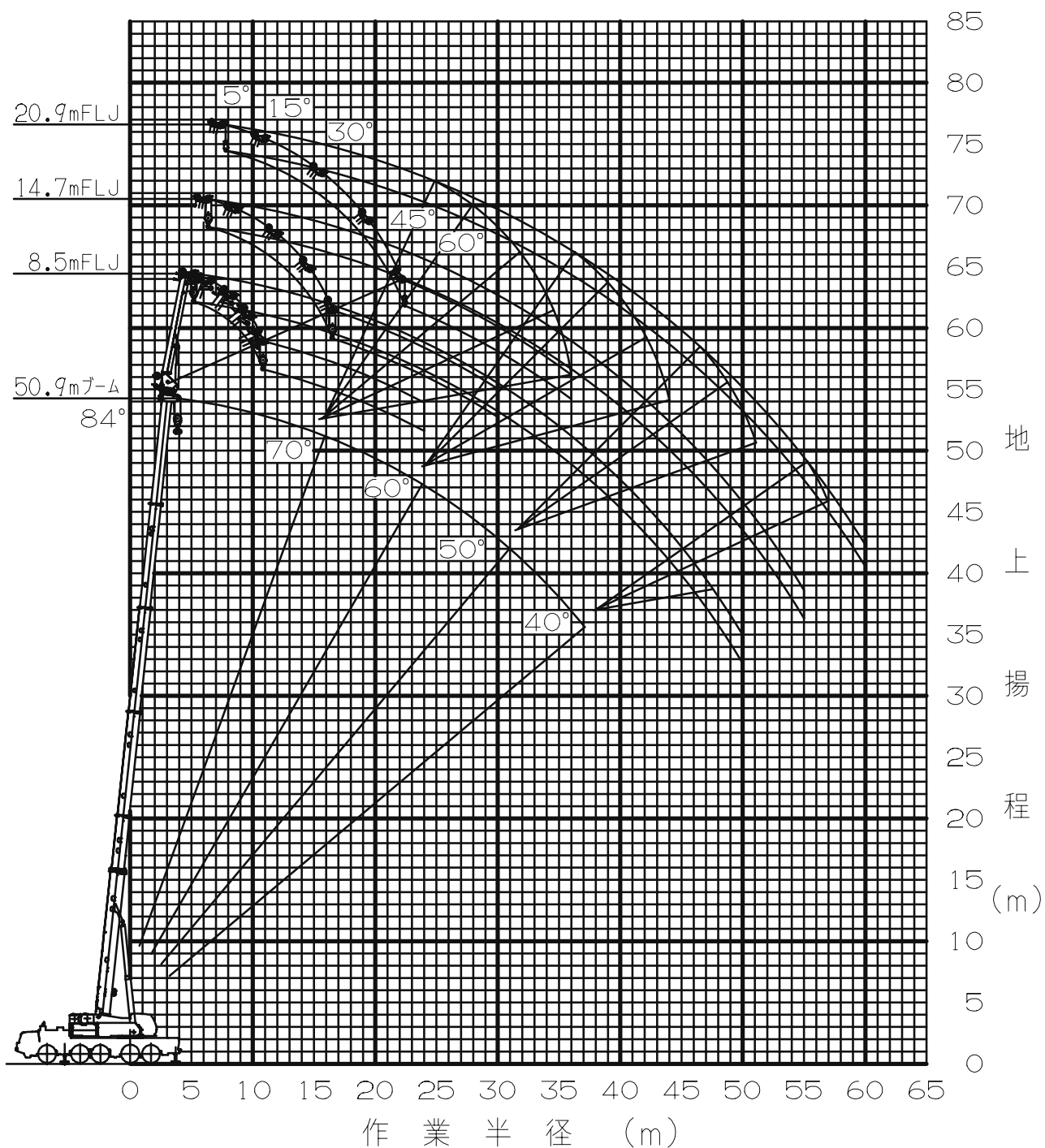

- (注) 1. 上図はブームおよびジブのたわみを含んでいません。
 2. FA性能の最大作業半径を図示しています。

55.0mブーム+1.85m+フルオートラフィングジブ

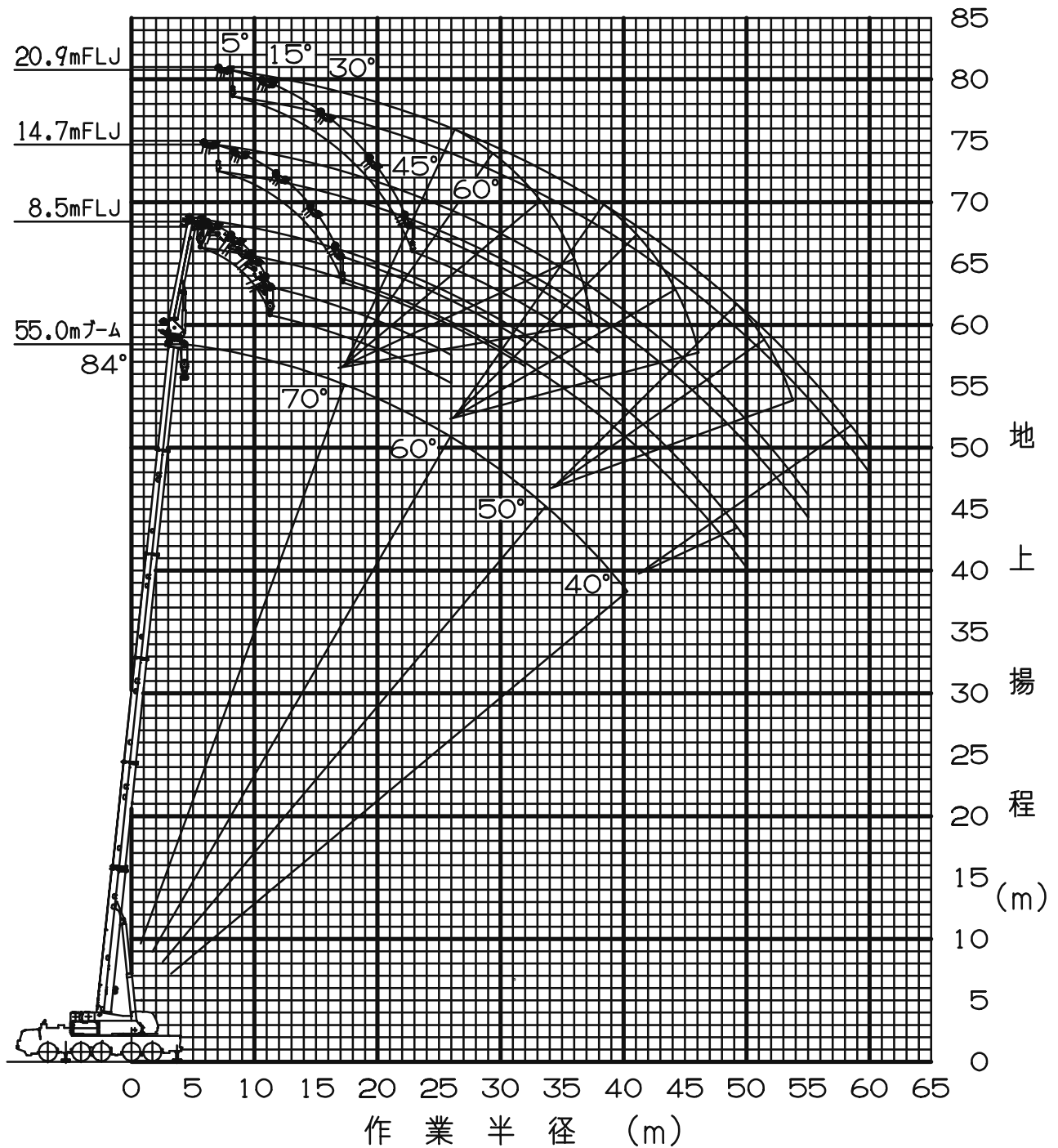

- (注) 1. 上図はブームおよびジブのたわみを含んでいません。
 2. FA性能の最大作業半径を図示しています。

59.2mブーム + 1.85m + フルオートラフィングジブ

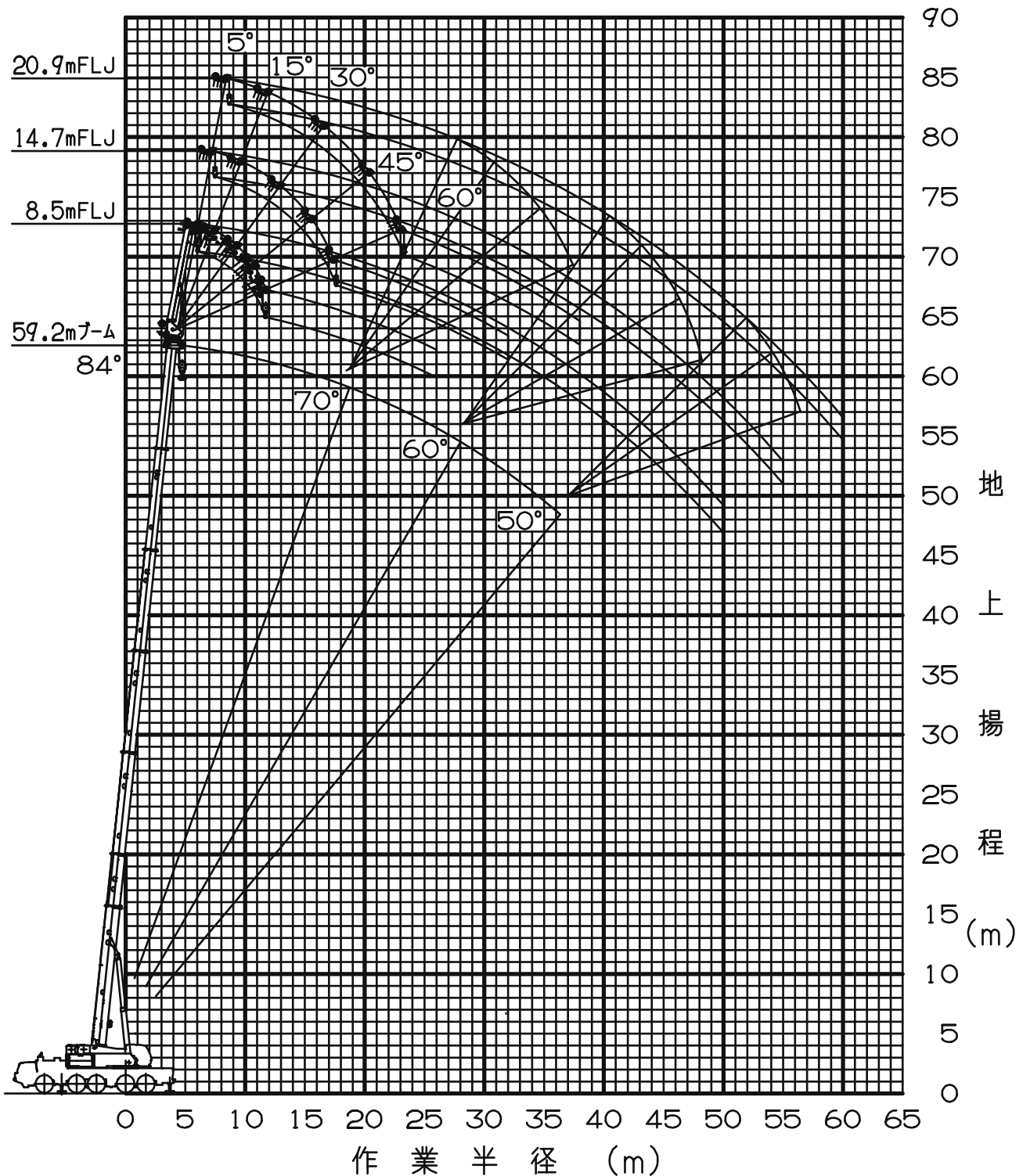

- (注) 1. 上図はブームおよびジブのたわみを含んでいません。
2. FA性能の最大作業半径を図示しています。

63.4mブーム + 1.85m + フルオートラフィングジブ

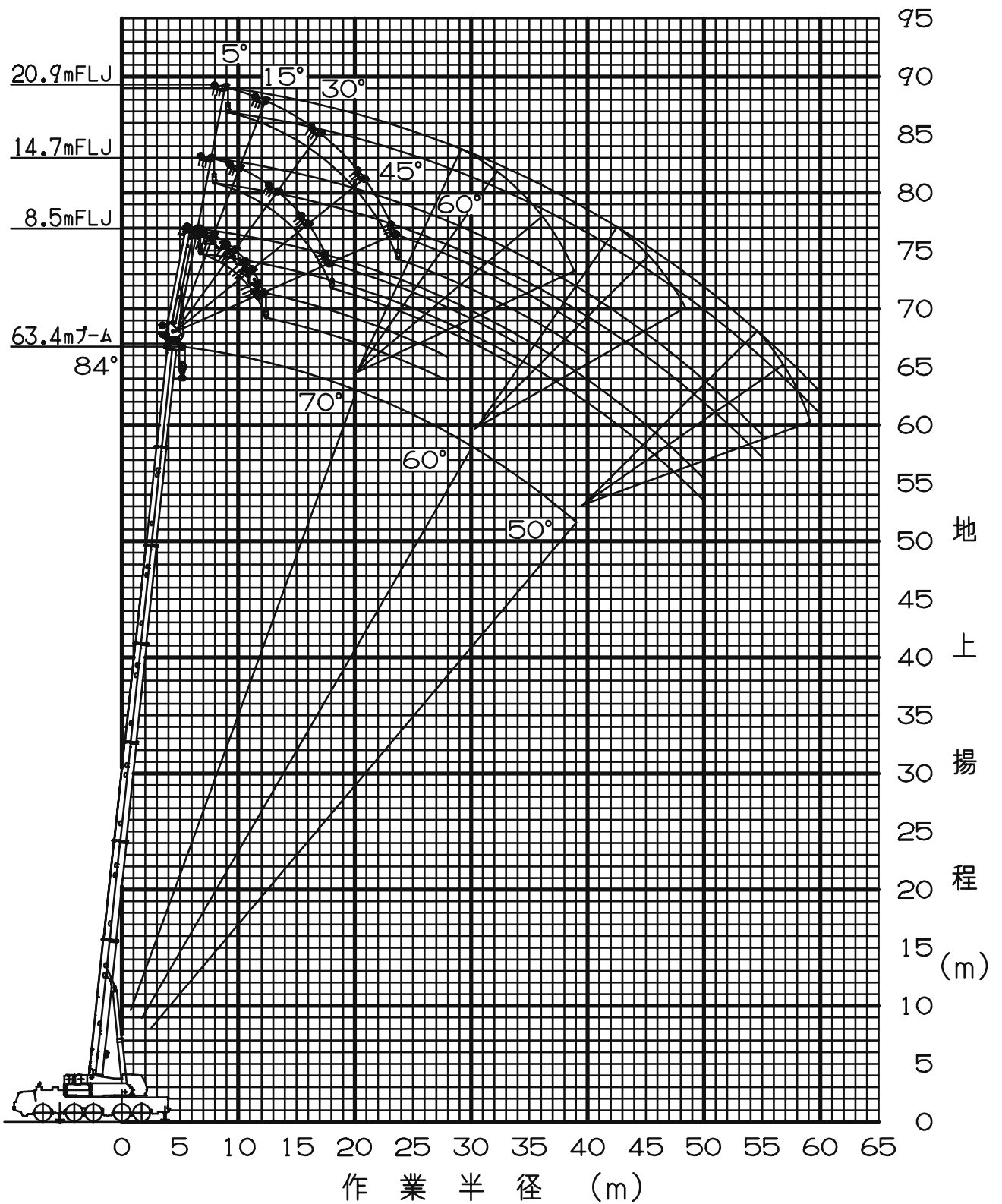

- (注) 1. 上図はブームおよびジブのたわみを含んでいません。
 2. FA性能の最大作業半径を図示しています。